



Distributed Generation Workbook for Minnesota Members (DG Workbook – MN)

Contents of MN DG Workbook

- Chapter 1: Introduction/Summary
- Chapter 2: FERC Rules for Compliance
- Chapter 3: Avoided Costs and Capacity Plans

MN Interconnection Process

Chapter 4:	MN Interconnection Process: Overview Exhibit A: MN Timelines
Chapter 5:	MN Interconnection Process: Simplified Exhibit A: MN Simplified Interconnection Application Exhibit B: MN Certificate of Completion Exhibit C: MN Standard Agreement
Chapter 6:	MN Interconnection Process: Fast Track Exhibit A: MN Interconnection Application Exhibit B: MN Standard Agreement Exhibit C: MN Interconnection Agreement
Chapter 7:	MN Interconnection Process: Study Exhibit A: MN Interconnection Application Exhibit B: MN Interconnection Agreement Exhibit C: MN Supplemental Review Offer Exhibit D: MN System Impact Study Agreement Exhibit E: MN Facilities Study Agreement Exhibit F: MN Transmission System Impact Study Agreement

Technical Requirements

Chapter 8:	MN Technical Specifications Manual Appendix A: Protection and Connection One-line Drawings Appendix B: Protective Relaying Elements
------------	---

- Chapter 9: Other Applications, Example Resolution, Forms, etc.
 - Exhibit A: MN Example Resolution
 - Exhibit B: MN Pre-application Report Request
 - Exhibit C: MN Storage Application

 = **Quick Start** : The Chapters needed for ≤ 20 kW inverter-based interconnection

INTRODUCTION TO DISTRIBUTED GENERATION INTERCONNECTION WITH YOUR LOCAL PUBLIC POWER UTILITY IN MINNESOTA

Your Local Public Power Electric Utility and Missouri River Energy Services

Your local public power electric utility is owned by the citizens of the community and operated for the distribution of electric power and energy to the consumer. Wholesale electric power supply is provided to your community by Western Area Power Administration (Western) and Missouri River Energy Services (MRES or Utility).

The base power supply resource from Western for your community is the hydroelectric power produced from the dams on the Missouri River constructed by the U.S. Army Corps of Engineers and marketed as firm power through Western. In the early 1970s, all preference power customers were informed that the hydroelectric system could not continue to supply all firm power requirements beyond the 1977 power and energy levels and thus would have to look elsewhere to meet the load growth requirements.

MRES, a joint action agency, began in the early 1960s as an informal association of northwest Iowa municipalities with their own electric systems, which decided to coordinate their efforts in negotiating power supply. MRES began supplying supplemental power and energy above the levels received from Western to communities, like yours, after 1977. Your community has executed a Power Sale Agreement (S-1) with MRES, pursuant to which MRES has agreed, to supply to S-1 Members all Supplemental Power requirements above the power supplied by Western. Such a comprehensive and exclusive agreement was needed in order to provide financial security to bond holders that have advanced funds to construct facilities for MRES. The term of the S-1 Agreement extends to January 1, 2057.

The Public Utility Regulatory Policies Act of 1978 (PURPA)

PURPA, as amended by the Energy Policy Act of 2005, requires your local utility (LOCAL UTILITY) to buy power and sell power to any Qualifying Facility (QF) at nondiscriminatory rates. The Federal Energy Regulatory Commission (FERC) has since issued certain rules and regulations which encourage small power production and cogeneration. PURPA and the FERC rules and regulations are not entirely clear when dealing with local utilities which have entered into long-term arrangements with a power supplier like MRES.

In certain circumstances, PURPA may require a duplication of obligations to buy and sell power with QFs where, for example, cooperatives, joint action agencies, and their respective LOCAL UTILITY each have statutory duties under PURPA to interconnect and exchange power with QFs. This means that both MRES and LOCAL UTILITY could be required to buy generation output of

the QF and sell supplemental, backup, and maintenance power (Standby Services) to a QF located within the LOCAL UTILITY service territory.

The LOCAL UTILITY and MRES filed a Petition of Waiver with FERC under Section 210 of PURPA and have been granted such from FERC. This limited Waiver continues to protect a QF's legitimate interests under PURPA, while clearing up the confusion as to which entity (the LOCAL UTILITY or MRES) is best situated to fulfill the PURPA obligations of buying and selling to a QF. This waiver also clears up any possible conflict with the S-1 Agreement that was signed by the LOCAL UTILITY by providing that the obligation to purchase the output from a QF is an obligation of MRES (the power supplier) and the obligation to provide interconnection and standby services is an obligation of the LOCAL UTILITY. As a condition of the waiver, FERC requires the LOCAL UTILITY and MRES to abide by a set of Rules for Compliance to carry out these requirements. (See Chapter 2.) These rules represent general guidelines since the nature, size, and character of QFs can vary widely. Policies have been prepared based upon these Rules for Compliance.

Qualifying Facilities: Cogeneration and Small Power Production

The purpose of PURPA Sections 201 and 210 and the FERC rules is to encourage the use of cogeneration and small power production facilities where such facilities might utilize alternate fuels and thus might make a significant contribution to the nation's effort to conserve energy resources.

PURPA defines these customer-owned distributed generation facilities by dividing them into several categories: small power production facilities, cogeneration facilities, and hydroelectric small power production facilities. Small power production facilities rely on biomass, waste, or renewable resources, including wind, solar, and geothermal to produce electric power. Cogeneration facilities simultaneously produce two forms of useful energy such as electric power and steam. Cogeneration facilities use significantly less fuel to produce electricity and steam (or other forms of energy) than would be needed to produce the two separately. Hydroelectric small power production facilities include a generation facility that impounds or diverts the water of a natural watercourse by means of a new dam or diversion. Any customer-owned generation that meets one of the above descriptions as defined by PURPA and authorized by FERC will be defined as a QF.

Under the FERC regulations and Petition of Waiver, the LOCAL UTILITY is generally obligated to interconnect with, and operate in parallel with, a QF. Parallel operation is the operation of on-site generation by a customer while the customer is connected to the LOCAL UTILITY's system. The LOCAL UTILITY is also required to sell electricity as Standby Service to generators who qualify under FERC standards, while MRES is required to purchase electricity from those QFs who qualify under FERC standards. All generation and transmission interconnections sought by QFs must comply with the requirements of the North American Electric Reliability Corporation (NERC), Midcontinent Independent System Operator, Inc. (MISO), Southwest Power Pool, Inc. (SPP), and/or other regional transmission providers.

FERC regulations allow the LOCAL UTILITY and MRES to establish interconnection standards to ensure electrical system safety and reliability. The regulations also make it clear that MRES, the LOCAL UTILITY and its retail customers are not to be detrimentally affected as a result of a customer interconnection. Thus, other customers should not have a higher cost of electricity or lower quality of service because of the QF's interconnection. MRES and the LOCAL UTILITY are not required to make uncompensated investments to interconnect with QFs.

As stated by FERC, the purchase rate from QFs is based on the cost that can be avoided by MRES with such purchases. Avoided costs are classified in two basic components: energy related and capacity related. Energy related avoided costs are those associated with the cost of not burning or purchasing certain fuels. In the near-term, the only costs that can be avoided are those associated with energy (i.e. not burning coal, nuclear fuel, oil, etc.). Capacity avoided costs are those associated with the capital cost of adding new generation, of a demand-side management (DSM)/energy efficiency option, or of the demand portion of a wholesale power purchase. If the QF has a reliable capacity value, then MRES will also include a capacity component as part of the purchase rate. Federal regulations require MRES to keep on file avoided cost data for five years and to update the data every two years. This can be requested from MRES at any time.

Any prospective customer who wishes to interconnect and operate in parallel with the LOCAL UTILITY should contact the LOCAL UTILITY and discuss the generation interconnect with LOCAL UTILITY staff. A set of documents defines the policies and general requirements for interconnection and parallel operation.

The Interconnection Process for the Local Utility in Minnesota

The State of Minnesota currently has interconnection process standards in effect to address the interconnection of distributed energy resources (DER) to the distribution grid. Under Minnesota Statute §216B.1611, cooperatives and municipals shall adopt an interconnection process that addresses the same issues as the interconnection process approved by the Minnesota Public Utilities Commission. The MN Interconnection Process (Interconnection Process or MIP) was developed by the Minnesota Municipal Utilities Association, working with STAR Energy Service LLC, and modified for use by Missouri River Energy Services (MRES) and its member municipal utilities (Local Utility). The MIP applies to any DER no larger than 10-megawatt (MW) AC interconnecting to and operating in parallel with the Local Utility's distribution system. This interconnection process document, called the DG Workbook-MN, is designed to be customer-centric when explaining the steps and details to interconnect DER systems to the distribution grid. In addition, this process was designed to be consistent with the Rules for Compliance with the FERC that every Local Utility and MRES agreed to follow with respect to the responsibilities of the Local Utility and MRES under PURPA.

Non-Qualifying Facilities: Standby Generation

The LOCAL UTILITY is not required to allow customer-owned distributed generation to operate in parallel with the LOCAL UTILITY electrical system if the generation does not satisfy qualifying status QF requirements. When a customer wishes to install non-qualifying generation, the LOCAL UTILITY will review these requests on a case-by-case basis. These facilities will only be connected to a LOCAL UTILITY by an approved transfer switch that will break the circuit connected to the LOCAL UTILITY'S electrical system before making the circuit with the customer's generation or with a LOCAL UTILITY-approved closed-transition switch. Standby Services will be available to the non-QF generation based on the LOCAL UTILITY's electric service rates, terms and conditions.

Disclaimer: This DG Workbook-MN was prepared, and is provided, by MRES to the LOCAL UTILITY to assist the LOCAL UTILITY in establishing distributed generation interconnection arrangements. The workbook does not constitute legal advice, and the LOCAL UTILITY should consult with its attorney on legal issues relating to distributed generation interconnection arrangements. Portions of the DG Workbook-MN may not be appropriate for the LOCAL UTILITY's specific system and other arrangements. The LOCAL UTILITY should modify the workbook as necessary to fit the LOCAL UTILITY's circumstances, but no modification may alter the rights or obligations of MRES with respect to distributed generation interconnection arrangements. In addition, the LOCAL UTILITY may not modify the "Rules for Compliance" contained in Chapter 2 of the DG Workbook-MN, which are based on a "Petition of Waiver" filed with the Federal Energy Regulatory Commission.

**RULES FOR COMPLIANCE
WITH
FEDERAL ENERGY REGULATORY COMMISSION ORDER NO. 69
COGENERATION AND SMALL POWER PRODUCTION**

1. Introduction

- 1.1 The Public Utility Regulatory Policies Act of 1978 (PURPA), under Section 210, requires the Federal Energy Regulatory Commission (FERC) to develop rules which encourage Cogeneration and Small Power Production. Pursuant to Section 210, regulations have been prepared by FERC and published in the Federal Register (45 FR 12214, February 25, 1980). Missouri Basin Municipal Power Agency, d.b.a. Missouri River Energy Services ("Utility") and its member municipal utilities ("Member"), which are nonregulated electric utilities, will implement, to the extent possible, the procedures and requirements of FERC Order no. 69, pursuant to these rules.
- 1.2 These rules apply to all entities willing and able to enter into an agreement with the Utility and its Members. Provisions of these rules shall not supersede existing contracts. Entities who have the status of "qualifying small power production facility" and/or "qualifying cogeneration facility" hereinafter referred to collectively as qualifying facility, pursuant to FERC Order No. 70 (45 FR 17959, March 20, 1980) are eligible to apply for service under these rules.
- 1.3 These rules represent general guidelines since the nature, size, and character of qualifying facilities can vary widely. The Utility reserves the right to evaluate qualifying facilities on a case by case basis.
- 1.4 The Utility is a wholesale supplier of power and energy to municipal Utilities; and as such, has no sales other than sales for resale. Qualifying facilities which seek to do business with the Utility shall interconnect with the Members, since the Utility has no sales for retail supplemental power, back-up power, maintenance power, and interruptible power.

2. Definitions: Terms as defined in Order No. 69 (18 CFR Part 292) shall have the same meaning for these rules unless further defined.

- 2.1 Accredited Capacity: The electrical rating given to generating equipment that meets the Utility's criteria for uniform rating of generating equipment. This criteria includes, but is not limited to, reliability, availability, type of equipment, and the degree of coordination between the qualifying facility and the Utility.
- 2.2 Capacity Costs: The costs associated with providing the capability to deliver energy. They consist of the capital costs of facilities used to generate and

transmit electricity or the cost to purchase such capacity from other utilities.

- 2.3 Demand: The average rate in kilowatts at which electric capacity is made available as determined at the point of measurement during any 30 minute period or any other period to be determined by the Utility.
 - 2.4 Energy: Electric energy as measured in kilowatt hours at the point of measurement.
 - 2.5 Energy Costs: The variable costs associated with the production of electric energy. They represent energy related cost only, or the average cost of purchased energy. Identifiable capacity charges included in purchased power agreements shall not be included in the calculation of the cost of purchased energy.
 - 2.6 Point of Measurement: The point or points where energy and/or demand are metered.
 - 2.7 Point of Interconnection: The point or points at which the qualifying facility is to receive and/or deliver energy or capacity and energy under normal operating conditions.
 - 2.8 Prudent Utility Practice: Any of the practices, methods, and acts engaged in, or approved by, a significant portion of the electrical utility industry consistent with reliability, safety, and expedition.
3. Conditions of Service: The conditions listed in this paragraph shall apply to all qualifying facilities served under these rules.
- 3.1 The Utility shall purchase energy or capacity and energy from any qualifying facility who offers to sell energy or capacity and energy.
 - 3.2 The Member interconnected with the qualifying facility shall sell any capacity and energy that is required by the qualifying facility to the qualifying facility. The qualifying facility shall be billed under the applicable residential, general, industrial, or contractual service schedule.
 - 3.3 The Member shall offer to provide maintenance, interruptible, supplementary, and back-up power to qualifying facility if requested by the qualifying facility.
 - 3.4 The qualifying facility shall execute written agreements with the Utility and the Member to be interconnected. The Utility reserves the right to waive this requirement. The waiving of this requirement by the Utility does not relinquish the Utility's right to require the execution of a written agreement in the future.

- 3.5 The qualifying facility shall comply with all requirements of the National Electrical Safety Code, American National Standards Institute, Institute of Electrical and Electronic Engineers, American Society of Mechanical Engineers, and any other applicable local, state, or national code and operate its equipment according to prudent utility practice. In case of any conflict in the foregoing codes or standards, the Utility shall decide which shall govern.
- 3.6 The Member shall interconnect in parallel with the qualifying facility. The qualifying facility shall, to the point of interconnection; furnish, install, operate, and maintain in good order and repair and without cost to the Utility or the Member such relays, locks and seals, breakers, automatic synchronizers, and other control and protective equipment as shall be designated by the Member as being required as suitable for the operation of the qualifying facility in parallel with the Member's system. The qualifying facility shall take appropriate steps to insure that operating in parallel will not degrade in any fashion the quality of service that is normally maintained on the Utility's or Member's systems.
- 3.7 Switching equipment capable of isolating the qualifying facility from the Member's system shall be assessable to the Member or its agent at all times.
- 3.8 At its option, the Member may choose to operate, without notice or liability, the switching equipment described in 3.6 and 3.7 above if, in the opinion of the Member or its agent, continued operation of the qualifying facility in connection with the Member's system may create or contribute to a system emergency or safety hazard. The Utility's obligation to purchase from the qualifying facility ceases when the Member or its agent operates the switching equipment described in 3.6 and 3.7 above. The Utility and the Member shall endeavor to minimize any adverse effects of such operation on the qualifying facility.
- 3.9 The qualifying facility shall indemnify and hold harmless the Member and the Utility from any and all liability arising from the operation and interconnection of the customer's facilities. The qualifying facility shall bear full responsibility for the installation and safe operation of the equipment required to generate and deliver energy or capacity and energy to the point of interconnection.
- 3.10 The Utility shall provide, upon request, sufficient data to allow the customer to determine the cost effectiveness of the qualifying facility if it goes into operation pursuant to these rules. The data given will conform to the outline given in § 292.302 (Order no. 69 - 45 FR Part 292).
- 3.11 Any costs of interconnection incurred by the Utility or the Member due to the interconnection of the qualifying facility, which are over and above the interconnection costs that would be incurred due to the connection of a

comparable non-generating customer, shall be the responsibility of the qualifying facility. Interconnection cost may be amortized over a period of time not greater than the length of the contract between the Utility and the qualifying facility.

- 3.12 The Utility may discontinue purchase from the qualifying facility if the Utility determines that purchase from the qualifying facility would result in cost greater than those which the Utility would incur if it did not make such purchases.
- 3.13 The Utility will give sufficient notice to the qualifying facility when it intends to invoke paragraph 3.12.
- 3.14 The Member may discontinue sales to the qualifying facility during a system emergency, providing that such discontinuance is on a nondiscriminatory basis.
- 3.15 By mutual agreement between the Utility and the qualifying facility, the Utility will transmit or arrange for the transmission of energy or capacity and energy to another utility for purchase by that utility. The Utility shall be fairly compensated for such transmission.
- 3.16 The qualifying facility shall provide an advance payment to the Utility if in the opinion of the Utility or the Member, as appropriate, the costs of interconnection will be excessive and/or the amount of work that must be done by the Member to provide the interconnection facilities will be excessive.
- 3.17 The Utility and the Member reserve the right to approve, inspect, and test the qualifying facility's generating equipment and all associated equipment.

4. Rates for Sales

- 4.1 The Utility shall purchase the surplus energy or surplus capacity and energy from qualifying facilities in which construction was commenced on or before November 8, 1978. The rate paid by the Utility to the qualifying facility for such surplus energy or surplus capacity and energy shall be a negotiated rate.
- 4.2 Qualifying facilities of 100 kW or less shall be paid a standard rate, except as otherwise stated in 4.1, based on avoided cost as outlined in 4.4 and 4.5. The installation of metering equipment shall be according to Utility policy.
- 4.3 For qualifying facilities of 100 kW or more, the qualifying facility may negotiate a contract with the Utility. For qualifying facilities who choose not to negotiate, or in the event of an impasse in negotiations between the Utility and the qualifying facility, avoided costs will be paid. Such avoided costs shall be determined as outlined in 4.4 and 4.5, except as otherwise stated in 4.1.

- 4.4 Avoided energy costs shall be the estimated or actual energy costs adjusted for the following items:
- A. The costs or savings to the Utility resulting from variations in line losses from those that would have existed in the absence of purchase from the qualifying facility, if the Utility generated or purchased an equivalent amount of energy.
 - B. Sanctions imposed for noncompliance with these rules and any contract between the Utility and the qualifying facility.
- 4.5 Capacity payments shall be made only in those periods of time in which the Utility is able to avoid capacity purchases and the qualifying facility enters into a legally enforceable contract to provide accredited capacity. The payment for the capacity purchase from the qualifying facility shall reflect the cost of the Utility's alternate source of capacity of similar capability. The capacity payments shall take into account the following items of information.
- A. Length of the contract term.
 - B. Reasonable scheduling of maintenance.
 - C. Willingness and ability of the customer to allow the Utility to dispatch the customer's generation.
 - D. The Utility's ability to defer a purchase from another source or to defer construction of a facility or a portion of a facility.
 - E. Sanctions imposed for noncompliance with these rules and any contract between the Utility and qualifying facility.
 - F. Availability and reliability of the qualifying facility.
- 4.6 In the event of the imposition of any tax or payment in lieu thereof on the Utility by any lawful authority on the production, transmission, sale, or purchase of energy or capacity and energy that would not occur due to a comparable non-generating customer, such tax or payment shall be the responsibility of the qualifying facility.

AVOIDED COSTS AND CAPACITY PLANS

MISSOURI RIVER ENERGY SERVICES COMPLIANCE WITH FEDERAL ENERGY REGULATORY COMMISSION'S REGULATIONS ORDER 69, 18 CFR PART 292.302

FERC has adopted certain rules and regulations which require MRES to prepare and maintain for public inspection electric utility system cost and rate data as defined in the regulations Section 292.302(b)(1) through (d).

The purpose of this submittal is to make available to potential cogenerators and small power producers present and anticipated future avoided cost data of electric energy and capacity for MRES. This data is intended to help potential owners of such QFs to evaluate the financial feasibility of a cogeneration or small power production project.

This data is not intended to represent a rate for purchases from QFs, but rather the first step towards rate determination.

Rates for QF

1. 100 kW or less: Any QF 100 kW or less shall be paid a standard rate as per PURPA or as otherwise required by law. MRES Board of Directors sets PURPA Standard Rate each year for the following calendar year.
2. Greater than 100 kW: Rates to QFs in this category are negotiated and will also take into consideration those factors enumerated in Section 292.304 of the regulations.

PURPA AVOIDED ENERGY COST
Section 292.302 (b) (1)
Date of last update: 11/2020

Avoided Energy Cost

Seasonal Avoided Energy Costs
(cents /kWh):

		2020*		2021		2022	
		Summer	Winter	Summer	Winter	Summer	Winter
On-Peak		2.01	1.88	2.24	2.10	2.32	2.18
Off-Peak		1.41	1.50	1.57	1.67	1.64	1.74

		2023		2024		2025	
		Summer	Winter	Summer	Winter	Summer	Winter
On-Peak		2.42	2.27	2.49	2.34	2.58	2.42
Off-Peak		1.71	1.82	1.77	1.88	1.82	1.94

Annual Avoided Costs (All Hours)
(cents per kWh):

2020*	2021	2022	2023	2024	2025
1.71	1.91	1.98	2.06	2.13	2.20

Rates

For QF facilities 100 kW or less, the PURPA Standard Rate is 1.91 cents per kWh for 2021 adopted in October 2020 by the MRES Board of Directors.

Qualifying facilities greater than 100 kW will be treated on a case-by-case basis as allowed by federal regulations.

* Historic as of 8/17/20

**Electric Utility's Plan for Additions of Capacity
Per PURPA
292.302 (b) (2)**

<u>Year</u>	<u>Planned Capacity Additions</u>			<u>Planned Capacity Retirements</u>	<u>Planned Firm Purchases</u>
	<u>Unit Name</u>	<u>Size (MW)</u>	<u>Unit Type</u>		
2020	Red Rock	55	Hydro	None	None
2025	Wind Gen	30	Wind	None	None
2026	Wind Gen	10	Wind	None	None
2033	Wind Gen	20	Wind	None	None

**Estimated Capacity Costs
Per PURPA
292.302 (b) (3)**

Planned Unit Addition or Firm Purchase	Planned Capacity Cost (\$/kW)
Red Rock Hydro Project(2020)	\$7,286
Wind Generation Project (2025)	n/a - leased
Wind Generation Project (2026)	n/a – leased
Wind Generation Project (2033)	n/a – leased

MN INTERCONNECTION PROCESS

Process Overview

SUMMARY

Interconnection Process for Distributed Energy Resources less than 10 megawatt (MW) interconnected to the Distribution System of a Municipal in the State of Minnesota.

Contents

- Foreword..... 1
- 1 Key Terminology..... 2**
 - 1.1. Distributed Energy Resource..... 2
 - 1.2. Point of Common Coupling (PCC) / Point of DER Connection (POC) 2
 - 1.3. Capacity 2
- 2 Roles..... 2**
 - 2.1. Overview 2
 - 2.2. DER Interconnection Coordinator 3
 - 2.3. Interconnection Customer 3
 - 2.4. Application Agent..... 3
 - 2.5. Engineering Roles..... 3
- 3 Processes 4**
 - 3.1. Overview 4
 - 3.2. Importance of Process Timelines 4
 - 3.3. Simplified Process 5
 - 3.4. Fast Track Process 5
 - 3.5. Study Process 6
 - 3.6. Process Assistance..... 6
- 4 Interconnection Application 6**
 - 4.1. Overview 6
 - 4.2. Availability of Information 7
 - 4.3. Interconnection Application Process Fees..... 7
 - 4.4. Application Review Timelines 7
 - 4.5. Comparability 8
 - 4.6. Changing Process Tracks 8
 - 4.7. Queue Position..... 8
 - 4.8. Site Control..... 9
- 5 Pre-Application Report 9**
 - 5.1. Pre-Application Report Requests..... 9

5.2.	Information Provided	10
5.3.	Pre-Application Report Components	10
6	Capacity of the Distributed Energy Resources	11
6.1.	Existing DER System Expansion	11
6.2.	New DER Systems.....	11
6.3.	Limited Capacity	11
7	Modification to Interconnection Applications	12
7.1.	Procedures	12
8	MN Interconnection Agreements	12
8.1.	Timelines	12
8.2.	Types of Agreements.....	13
9	Interconnection	13
9.1.	Metering.....	13
9.2.	Inspection, Testing and Commissioning.....	13
9.3.	Interconnection Costs	14
9.4.	Technical Requirements.....	14
9.5.	Authorization for Parallel Operations	14
10	Extension of Timelines	15
10.1.	Reasonable Efforts.....	15
10.2.	Extensions.....	15
11	Disputes	15
11.1.	Procedures.....	15
12	Clauses	15
12.1.	Confidentiality	15
12.2.	Non-Warranty.....	17
12.3.	Indemnification.....	17
12.4.	Limitation of Liability	18
13	Glossary	19
14	Certification of DER Equipment	25

Foreword

The State of Minnesota currently has interconnection process standards in effect to address the interconnection of distributed energy resources (DER) to the distribution grid. Under Minnesota Statute §216B.1611, cooperatives and municipals shall adopt an interconnection process that addresses the same issues as the interconnection process approved by the Minnesota Public Utilities Commission. The MN Interconnection Process (Interconnection Process or MIP) was developed by the Minnesota Municipal Utilities Association, working with STAR Energy Service LLC, and modified for use by Missouri River Energy Services (MRES) and its member municipal utilities (Local Utility). The MIP applies to any DER no larger than 10-megawatt (MW) AC interconnecting to and operating in parallel with the Local Utility's Distribution System. This interconnection process document is designed to be customer-centric when explaining the steps and details to interconnect DER systems to the distribution grid. In addition, this process was designed to be consistent with the Rules for Compliance with the Federal Energy Regulatory Commission (FERC) that every Local Utility and MRES agreed to follow with respect to the responsibilities of the Local Utility and MRES under the Public Utility Regulatory Policies Act of 1978 (PURPA).

The MIP is divided into three tracks: Simplified Process, Fast Track Process, and Study Process. This Chapter 4, the Process Overview, generally describes the process along with terms and conditions that govern each of the three interconnection process tracks. For most DER interconnections, only the Process Overview and the Simplified Process will apply. For larger and more complex DER interconnections, the Fast Track Process or Study Process may apply.

As part of the Interconnection Process documents, the MN Interconnection Agreement(s) are to be executed prior to interconnecting a DER system to the utility distribution grid. For most DER interconnections, the Local Utility's MN Standard Agreement which is developed for 100 kW or less generation units will be used. For DER systems that do not fall under the terms of the MN Standard Agreement, the MN Interconnection Agreement will apply.

The process to interconnect a DER system to the distribution grid starts with the submission of an Interconnection Application. Each track has different information that is requested in the application and the non-refundable interconnection application fees will vary. Both the Local Utility and the interconnecting customer have timelines that are enforced to ensure a timely application review, contract execution and interconnection commissioning.

The key to a successful interconnection of a DER system is communication between all parties. Timely submission of the Interconnection Application prior to the purchase and installation of a DER system is strongly recommended. The Local Utility encourages customers to ask questions throughout the interconnection process.

1 Key Terminology

1.1. Distributed Energy Resource

Distributed Energy Resource (DER) is often referred to in interconnection processes as Distributed Generation (DG) and on occasion is also interchanged with the term Qualifying Facility (QF). This Interconnection Process uses the term DER to address all types of generation and energy resources that can be interconnected to the electric Distribution System. DER technologies can include photovoltaic solar systems, wind turbines, storage batteries or diesel generators and are not limited to renewable types of technologies.

1.2. Point of Common Coupling (PCC) / Point of DER Connection (POC)

DER systems often reside behind the Local Utility's revenue meter of a residence or business. The meter is normally the point of demarcation between the Local Utility-owned equipment and the customer-owned equipment. The term Point of Common Coupling (PCC) is the demarcation location between the Local Utility and the customer.

The Point of DER Connection (PoC) can be different from the PCC. The PoC is the location where a DER system would interconnect to the electrical system normally owned by the customer. For example, the PoC for a rooftop photovoltaic solar system may be the main electrical panel in a customer's home.

1.3. Capacity

Throughout the Interconnection Process will be references to the capacity of the DER system. In most cases, the capacity listed is referring to the Nameplate Capacity of the DER system. All capacity referenced in the Interconnection Process will be in alternating current (AC).

There can be multiple DER systems with different PoCs that all have the same PCC submitted on a single interconnection application. The capacity for this type of interconnection would be the aggregate Nameplate Capacity of all DER systems at the individual PoCs. Additional examples of DER system arrangements can be seen in Section 13 under the definition of Point of Common Coupling.

2 Roles

2.1. Overview

During the Interconnection Process for a proposed DER system, there may be multiple entities involved in the application, approval and commissioning processes. The main entities that are involved during the Interconnection Process for a proposed DER

system are the Interconnection Customer, the Application Agent and the DER Interconnection Coordinator. Official definitions of each entity are defined in the Glossary (Section 13). Additional details are explained in the subsections below.

2.2. DER Interconnection Coordinator

The Local Utility is referred to as the Area Electric Power Supply (Area EPS) Operator in this Interconnection Process. The Area EPS Operator shall designate a DER Interconnection Coordinator to serve as a single point of contact from which general information on the application process may be obtained. The DER Interconnection Coordinator shall be available to provide coordination assistance with the Interconnection Customer but is not responsible for directly answering or resolving all of the issues involved in review and implementation of the Interconnection Process and standards.

The contact information of the DER Interconnection Coordinator will be posted on the Area EPS Operator's website if feasible.

2.3. Interconnection Customer

The owner of the proposed DER system and the entity requesting interconnection to the distribution system.

2.4. Application Agent

The Interconnection Customer may designate, on the Interconnection Application or in writing after the application has been submitted, an Application Agent to serve as a single point of contact to coordinate with the DER Interconnection Coordinator on their behalf. Designation of an Application Agent does not absolve the Interconnection Customer from signing application documents and the responsibilities outlined in the Interconnection Process or in MN Interconnection Agreements. DER vendors, project managers or electricians are common entities that the Interconnection Customer may designate to perform this role.

2.5. Engineering Roles

Each party may designate a specific person to be a single point of contact to provide technical expertise during the Interconnection Process for themselves or their organization. The person to supply engineering expertise may be a third party such as an engineering consultant or manufacturer's engineer.

3 Processes

3.1. Overview

The Interconnection Process applies to any DER no larger than 10 MW AC interconnecting to and operating in parallel with an Area EPS Distribution System in Minnesota. Interested parties with plans to interconnect DER systems larger than 10 MW AC to the Distribution System should contact the Area EPS Operator for the specific interconnection process. The Federal Energy Regulatory Commission’s (FERC) interconnection rules will supersede any interconnection process the Area EPS Operator has for DER system interconnections.

The Interconnection Process for DER is broken into three different tracks: the Simplified Process, the Fast Track Process, and the Study Process. The general classification of each track is summarized in Table 3.1 below.

Table 3.1. Interconnection Process Tracks

Track	DER Technology	Size Limitations
Simplified Process	Certified Inverter only	20 kW AC
Fast Track Process	All types	5 MW AC
Study Process	All types	10 MW AC

If engineering screens are failed during the application process, a proposed DER interconnection may be moved into a different track. When a proposed DER interconnection is moved into a different track, additional information may be requested and additional fees may apply.

3.2. Importance of Process Timelines

It is very important to pay attention to timelines listed for each process track. The timelines exist for an orderly and efficient process to interconnect DER systems to the Distribution System. If a timeline is missed by an Interconnection Customer, without the Interconnection Customer requesting a timeline extension explained in Section 10, the Interconnection Application will be deemed withdrawn by the Area EPS Operator.

The Area EPS Operator also must abide by the timelines listed for each process track. The process for an Area EPS Operator to request timeline extensions is also addressed in Section 10.

Unless otherwise stated, all time frames are measured in Business Days. For purposes of measuring these time intervals, the time shall be computed so as to exclude the first

and include the last day of the prescribed duration of time. Any communication sent or received after 4:30 p.m. Central Prevailing Time or on a Saturday, Sunday or Holiday shall be considered to be sent on the next Business Day.

3.3. Simplified Process

An application to interconnect a certified¹, inverter-based DER system no larger than 20 kilowatts (kW) shall be evaluated under the Simplified Process. A common form of DER inverter certification is UL 1741. Proposed DER systems that require Area EPS system modifications to accommodate the interconnection do not qualify for the Simplified Process. A transformer change, fusing upgrades or line extensions are common examples of Area EPS system modification. Simplified Process eligibility does not imply or indicate the Interconnection Application will pass the initial review screens. Failure to pass the screens will route the Interconnection Application to the Fast Track Process.

3.4. Fast Track Process

An application to interconnect a DER shall be evaluated under the Fast Track Process if the eligibility requirements are not exceeded in Table 3.2 and the application does not qualify for the Simplified Process. Fast Track eligibility for DERs is determined based upon the generator type, the size of the generator, voltage of the line, and the location and type of line at the Point of Common Coupling (PCC). All synchronous and induction machines must be no larger than 2 MW to be eligible for Fast Track Process consideration.

Table 3.2. Fast Track Eligibility for DER

Line Voltage	Fast Track Eligibility² Regardless of Location	Fast Track Eligibility for certified, inverter-based DER on a Mainline³ and ≤ 2.5 Electrical Circuit Miles from Substation⁴
< 5 kV	≤ 500 kW	≤ 500 kW
≥ 5 kV and < 15 kV	≤ 1 MW	≤ 2 MW
≥ 15 kV and < 30 kV	≤ 2 MW	≤ 4 MW
≥ 30 kV and ≤ 69 kV	≤ 4 MW	≤ 5 MW

¹ Additional information regarding certified equipment is found in Section 14 and the Minnesota Technical Requirements.

² Synchronous and induction machine eligibility is limited to no more than 2 MW even when line voltage is greater than 15 kV.

³ For purposes of this table, a Mainline is the three-phase backbone of a circuit. It will typically constitute lines with wire sizes of 4/0 American wire gauge, 266 kcmil, 336.4 kcmil, 397.5 kcmil, 477 kcmil and 795 kcmil.

⁴ An Interconnection Customer can determine this information about its proposed interconnection location in advance by requesting a pre-application report described in Section 5.

In addition to the size threshold, the Interconnection Customer’s proposed DER must meet the codes, standards and certification requirements found in Section 14 and the Minnesota Technical Requirements.

3.5. Study Process

An application to interconnect a DER that does not meet the Simplified Process or Fast Track Process eligibility requirements or does not pass the review as described in either process, shall be evaluated under the Study Process.

3.6. Process Assistance

Prior to submitting an Interconnection Application, the Interconnection Customer may ask the Area EPS Operator’s DER Interconnection Coordinator which process track a proposed interconnection is subject to and about additional details regarding each process track.

An Interconnection Customer can obtain, through an informal request, general information about the Interconnection Process and potentially Affected System(s) for a proposed interconnection at a specific location. The existing electric system information provided to the Interconnection Customer should include relevant system study results, interconnection studies, and other materials useful to an understanding of an interconnection at a particular point on the Area EPS Operator’s System. Information will be provided to the extent such provision does not violate the privacy policies of the Area EPS Operator, confidentiality provisions of prior agreements or critical infrastructure requirements. The Area EPS Operator shall comply with reasonable requests for such information.

4 Interconnection Application

4.1. Overview

Each process track has different information that needs to be provided to the Area EPS Operator. Table 4.1 indicates which application is to be completed in its entirety and submitted to the Area EPS Operator to start the interconnection process for the proposed DER system.

Table 4.1. Interconnection Application

Process Track	Application
Simplified	Simplified Interconnection Application
Fast Track	Standard Interconnection Application
Study	Standard Interconnection Application

The Area EPS Operator will accept Interconnection Applications submitted electronically to an email address specified by the Area EPS Operator.

4.2. Availability of Information

The Area EPS Operator will attempt to provide all necessary Interconnection Applications, Interconnection Process documents and sample MN Interconnection Agreements on its website if possible. If a website is not available, the applicable documents will be readily available at the Area EPS Operator’s main office.

The Area EPS Operator will establish a public queue of active interconnection applications on its website once the Area EPS Operator has received at least 40 completed Interconnection Applications in a year. The public queue will be updated, at minimum, on a monthly basis.

4.3. Interconnection Application Process Fees

Each Interconnection Application submitted to the Area EPS Operator must include the appropriate interconnection application process fee prior to the Area EPS Operator reviewing the Interconnection Application. The required process fee for each process track is listed in Table 4.2.

Table 4.2. Interconnection Application Process Fee

Process Track		Process Fee
Simplified		\$100
Fast Track	Certified ⁵ System	\$100 + \$1/kW
	Non-Certified System	\$100 + \$2/kW
Study		\$1,000 + \$2/kW down payment. Additional study fees may apply.

4.4. Application Review Timelines

The Interconnection Application shall be date- and time-stamped upon initial, and if necessary, resubmission receipt. The Area EPS Operator shall notify the Interconnection Customer within ten (10) Business Days if the Interconnection Application is deemed incomplete. This notification shall include a written list detailing all information that must be provided to complete the Interconnection Application. Depending on the process track, the Interconnection Customer has between five (5) and ten (10) Business Days to provide the missing information unless the

⁵ Additional information regarding certified equipment is found in Section 14 and the Minnesota Technical Requirements.

Interconnection Customer submits a valid request for a timeline extension. Failure to submit the requested information within the stated timeline will result in the Interconnection Application being withdrawn.

An Interconnection Application will be deemed complete upon submission to the Area EPS Operator when all documents, fees and information required with the Interconnection Application adhering to Minnesota Technical Requirements are included. The time- and date- stamp of the completed Interconnection Application shall be accepted as the qualifying date for purposes of establishing a queue position as described in Section 4.7.

Depending on the process track, the Area EPS Operator has either a total of twenty (20) Business Days or twenty-five (25) Business Days to complete the Interconnection Application review and notify the Interconnection Customer as to whether the proposed DER system may proceed with the Interconnection Process or requires additional engineering studies. The period of time when waiting for the Interconnection Customer to provide missing information is not included in the Area EPS Operator's twenty (20) Business Days or twenty-five (25) Business Days review timeline (See Exhibit A for summary of timelines).

4.5. Comparability

The Area EPS Operator shall receive, process and analyze all Interconnection Applications in a timely manner. The Area EPS Operator shall use the same Reasonable Efforts in processing and analyzing Interconnection Applications from all Interconnection Customers.

4.6. Changing Process Tracks

During the review of the initially submitted Interconnection Application for the proposed DER system, the Area EPS Operator may determine the proposed DER system should be in a different process track. For proposed DER systems that are moved into a different process track after submittal of the initial application, the difference between the originally submitted processing fee and the current process track's processing fee will be assessed. In addition, the Area EPS Operator may request the Interconnection Customer to provide additional information regarding the proposed DER system.

4.7. Queue Position

The Area EPS Operator shall maintain a single, administrative queue and may manage the queue by geographical region. The queue position of each completed Interconnection Application is used to determine the engineering review. The queue

position is also used to determine the cost responsibility for system upgrades necessary to accommodate the interconnection.

An Interconnection Application will retain its queue number even when it is moved into a different process track. An Interconnection Application can lose its queue position if the Interconnection Customer misses timelines in the applicable process track. The Interconnection Customer and Area EPS Operator have the opportunity to request timeline extensions as explained in Section 10.

4.8. Site Control

Documentation of site control must be submitted with the Interconnection Application. Site control may be demonstrated by any of the following:

- Ownership of, a leasehold interest in, or a right to develop a site for the purpose of constructing the DER system.
- An option to purchase or acquire a leasehold site for constructing the DER system.
- An exclusivity or other business relationship between the Interconnection Customer and the entity having the right to sell, lease, or grant to the Interconnection Customer the right to possess or occupy a site for constructing the DER system.

For DER in the Simplified Process, proof of site control may be demonstrated by the site owner's signature on the Simplified Interconnection Application.

5 Pre-Application Report

5.1. Pre-Application Report Requests

The Interconnection Customer may submit a Pre-Application Report Request, including a non-refundable fee of \$300, for a Pre-Application Report on a proposed project at a specific site. The Interconnection Customer must fill out the Pre-Application Request form as completely as possible. The Area EPS Operator shall provide the readily available data listed in Section 5.3 within fifteen (15) Business Days of receipt of a completed request form and payment. The Pre-Application Report produced by the Area EPS Operator is non-binding, does not confer any rights, and does not preclude the Interconnection Customer from any interconnection process steps including submission of the Interconnection Application.

5.2. Information Provided

Using the information provided in the Pre-Application Report Request form, the Area EPS Operator will identify the substation/area bus, bank or circuit likely to serve the proposed PCC. This selection by the Area EPS Operator does not necessarily indicate, after application of the screens and/or study, that this would be the circuit to which the project ultimately connects. The Interconnection Customer must request additional Pre-Application Reports if information about multiple PCCs is requested.

The Pre-Application Report will only include existing data. A request for a Pre-Application Report does not obligate the Area EPS Operator to conduct a study or other analysis of the proposed DER in the event that data is not readily available. The Area EPS Operator will provide the Interconnection Customer with the data that is available. The confidentiality provisions in Section 12.1 apply to Pre-Application Reports.

5.3. Pre-Application Report Components

The Pre-Application Report shall include the following information, provided the data currently exists and is readily available:

- Total capacity (in megawatts (MW)) of substation/area bus, bank or circuit based on normal or operating ratings likely to serve the proposed PCC.
- Existing aggregate generation capacity (in MW) interconnected to a substation/area bus, bank or circuit (i.e. amount of generation online) likely to serve the proposed PCC.
- Aggregate queued generation capacity (in MW) for a substation/area bus, bank or circuit (i.e. amount of generation in the queue) likely to serve the proposed PCC.
- Available capacity (in MW) of substation/area bus or bank and circuit likely to serve the proposed PCC (i.e. total capacity less the sum of existing aggregate generation capacity and aggregate queued generation capacity).
- Substation nominal distribution voltage and/or transmission nominal voltage, if applicable.
- Nominal distribution circuit voltage at the proposed PCC.
- Approximate circuit distance between the proposed PCC and the substation.
- Relevant line section(s) actual or estimated peak load and minimum load data, including daytime minimum load and absolute minimum load, when available.

- Whether the PCC is located behind a line voltage regulator.
- Number and rating of protective devices and number and type (standard, bi-directional) of voltage regulating devices between the proposed PCC and the substation/area. Identify whether the substation has a load tap changer.
- Number of phases available on the Area EPS medium voltage system at the proposed PCC. If a single phase, distance from the three-phase circuit.
- Limiting conductor ratings from the proposed PCC to the distribution substation.
- Whether the PCC is located on a spot network, grid network, or radial supply.
- Based on the proposed PCC, existing or known constraints such as, but not limited to, electrical dependencies at that location, short circuit interrupting capacity issues, power quality or stability issues on the circuit, capacity constraints, or secondary networks.

6 Capacity of the Distributed Energy Resources

6.1. Existing DER System Expansion

If the Interconnection Application is for an increase in capacity to an existing DER system, the Interconnection Application shall be evaluated on the basis of the total new alternating current (AC) capacity of the DER. The maximum capacity for the DER shall be the aggregate maximum Nameplate Rating unless the conditions in Section 6.3 are met.

6.2. New DER Systems

An Interconnection Application for a DER that includes multiple energy production devices (i.e. solar and storage) at a site for which the Interconnection Customer seeks a simple Point of Common Coupling, shall be evaluated on the basis of the aggregated maximum Nameplate Rating unless the conditions in Section 6.3 are met.

6.3. Limited Capacity

A DER system may include devices (i.e. control systems, power relays or other similar device settings) that can limit the maximum capacity at which the DER system can generate into the Area EPS Operator's distribution system. For a DER system that include capacity limited devices, the Interconnection Customer must obtain the Area EPS Operator's agreement to consider the DER system with the Nameplate Rating as the limited capacity. The Area EPS Operator's agreement shall not be unreasonably

withheld if proper documentation is provided showing the effective limit active power output will not adversely affect the safety and reliability of the Area EPS Operator's distribution system. If the Area EPS Operator does not agree, the Interconnection Application must be withdrawn or revised to specify the maximum capacity that the DER system is capable of injecting into the Area EPS Operator's distribution system without such limitations. Nothing in this section shall prevent the Area EPS Operator from considering a higher output (i.e. aggregate Nameplate Rating), if the limitations do not provide adequate assurance, when evaluating the system impacts.

7 Modification to Interconnection Applications

7.1. Procedures

At any time after the Interconnection Application is deemed complete, the Interconnection Customer or the Area EPS Operator may identify modifications to the proposed DER system that may improve costs and benefits (including reliability) of the proposed DER system and the ability for the Area EPS Operator to accommodate the proposed DER system. The Interconnection Customer shall submit to the Area EPS Operator in writing all proposed modifications to any information provided in the Interconnection Application. The Area EPS Operator cannot unilaterally modify the Interconnection Application.

Additional information regarding modifications to interconnection applications is found in each process track document.

8 MN Interconnection Agreements

8.1. Timelines

After the Interconnection Application has been approved by the Area EPS Operator, the Area EPS Operator shall provide the Interconnection Customer with an executable MN Interconnection Agreement within five (5) Business Days. The Interconnection Customer shall have thirty (30) Business Days to sign and return the MN Interconnection Agreement to the Area EPS Operator. The Area EPS Operator shall sign the MN Interconnection Agreement within five (5) business days after receiving the signed MN Interconnection Agreement from the Interconnection Customer.

If the Interconnection Customer fails to return a signed MN Interconnection Agreement to the Area EPS Operator within thirty (30) Business Days and fails to request an extension as explained in Section 10, the Interconnection Application will be deemed withdrawn.

8.2. Types of Agreements

There are two main types of MN Interconnection Agreements that may be executed with an approved Interconnection Application. In general, Interconnection Customers with a proposed DER system that qualifies for the Simplified Process track will sign the MN Standard Agreement. Proposed DER systems 100 kW or less that are under the Fast Track process may also sign the MN Standard Agreement. All other sized DER system will sign the MN Interconnection Agreement.

Table 8.1. MN Interconnection Agreements

Process Track		MN Interconnection Agreement
Simplified		MN Standard Agreement
Fast Track	Qualifies for Net Energy Billing	MN Standard Agreement
	100 kW or Less & Area EPS Agrees to Purchase Excess Generation	MN Standard Agreement
	All Other DER systems	MN Interconnection Agreement
Study		MN Interconnection Agreement

Interconnection Customers may choose to sign the MN Interconnection Agreement in lieu of the MN Standard Agreement. A separate power purchase agreement will also need to be executed if the MN Standard Agreement is not utilized. Interconnection of the proposed DER system will not occur until a signed MN Standard Agreement or the MN Interconnection Agreement is returned to the Area EPS Operator no later than five (5) days prior to scheduled testing and inspection of the DER system and the Customer’s Interconnection Facilities.

9 Interconnection

9.1. Metering

Any metering requirements necessitated by the use of the DER system shall be installed at the Interconnection Customer’s expense. The metering requirement costs will be included in the final invoice of interconnection costs to the Interconnection Customer. The Interconnection Customer is also responsible for metering replacement costs not covered in the Interconnection Customer’s general customer charge. The Area EPS Operator may charge Interconnection Customers an ongoing metering-related charge for an estimate of ongoing metering-related costs specifically demonstrated.

9.2. Inspection, Testing and Commissioning

The Interconnection Customer shall arrange for the inspection and testing of the DER system and the Customer’s Interconnection Facilities prior to interconnection pursuant to Minnesota Technical Requirements. Commissioning tests of the Interconnection

Customer's installed equipment shall be performed pursuant to applicable codes and standards of Minnesota's Technical Requirements.

The Interconnection Customer shall notify the Area EPS Operator of testing and inspection no fewer than five (5) Business Days in advance, or as may be agreed to by the Parties. Depending on the process track, either a Certificate of Completion or a testing procedure shall be submitted to the Area EPS Operator prior to the testing and inspection date. The Area EPS Operator shall, and MRES may, send qualified personnel to the DER site to inspect the interconnection and witness the testing. Testing and inspection shall occur on a Business Day at a mutually agreed upon time and date. The Area EPS Operator and MRES may waive the right to witness the testing.

9.3. Interconnection Costs

The Interconnection Customer shall pay for the actual cost of the Interconnection Facilities and Distribution Upgrades along with the Area EPS Operator's cost to commission the proposed DER system. An estimate of the interconnection costs shall be stated in the MN Standard Agreement or MN Interconnection Agreement.

9.4. Technical Requirements

The Area EPS Operator shall use Reasonable Efforts to provide the Interconnection Customer the Minnesota Technical Requirements by providing the document with the notice of approval of the interconnection application or by providing a website link to the document. Additionally, the Area EPS Operator shall notify the Interconnection Customer of any changes to these requirements as soon as they are known. Unless notified by the Area EPS Operator, the Interconnection Customer only needs to be in compliance with the current version of the Minnesota Technical Requirements at the time of interconnection.

9.5. Authorization for Parallel Operations

The Interconnection Customer shall not operate its DER system in parallel with the Area EPS Operator's distribution system without prior written authorization from the Area EPS Operator. The Area EPS Operator shall provide such authorization within three (3) Business Days from when the Area EPS Operator receives notification that all of the following have occurred: 1) the Interconnection Customer has complied with all applicable parallel operations requirements; 2) the completion of a successful testing and inspection of the DER system; and 3) all payments for issued bills related to the Interconnection Process that are past due have been paid in full. Such authorization shall not be unreasonably withheld, conditioned or delayed.

10 Extension of Timelines

10.1. Reasonable Efforts

The Area EPS Operator shall make Reasonable Efforts to meet all time frames provided in these procedures. If the Area EPS Operator cannot meet a deadline provided herein, it must notify the Interconnection Customer in writing within three (3) Business Days after the deadline to explain the reason for the failure to meet the deadline and provide an estimated time by which it will complete the applicable interconnection procedure in the process.

10.2. Extensions

For applicable time frames described in these procedures, the Interconnection Customer may request, in writing, one extension equivalent to half of the time originally allotted (e.g. ten (10) Business Days for a twenty (20) Business Days original time frame) which the Area EPS Operator may not unreasonably refuse. No further extensions for the applicable time frame shall be granted absent a Force Majeure Event or other similarly extraordinary circumstance.

11 Disputes

11.1. Procedures

The Parties agree to use good faith efforts to attempt to resolve all disputes arising out of the Interconnection Process and associated study and MN Interconnection Agreements. The Parties agree to follow the established dispute resolution policy adopted by the Area EPS Operator.

12 Clauses

12.1. Confidentiality

Confidential Information shall mean any confidential and/or proprietary information provided by one Party to the other Party that is clearly marked or otherwise designated "Confidential." For purposes of these procedures, design, operating specifications, and metering data provided by the Interconnection Customer may be deemed Confidential Information regardless of whether it is clearly marked or otherwise designated as such. If requested by a Party, the other Party shall provide in writing the basis for asserting that the information warrants confidential treatment. Parties providing a Governmental Authority trade secret, privileged or otherwise not public or nonpublic data under Minnesota Government Data Practices Act, Minnesota Statutes Chapter 13, shall identify such data consistent with the Commission's September 1, 1999 Revised Procedures for Handling Trade Secret and Privileged Data, available online at: <https://mn.gov/puc/puc-documents/#4>.

Confidential Information does not include information previously in the public domain with proper authorization, required to be publicly submitted or divulged by Governmental Authorities (after notice to the other Party and after exhausting any opportunity to oppose such publication or release), or necessary to be publicly divulged in an action to enforce these procedures. Each Party receiving Confidential Information shall hold such information in confidence and shall not disclose it to any third party nor to the public without prior written authorization from the Party providing that information, except to fulfill obligations under these procedures, or to fulfill legal or regulatory requirements that could not otherwise be fulfilled by not making the information public.

Each Party shall hold in confidence and shall not disclose Confidential Information, to any person (except employees, officers, representatives and agents, who agree to be bound by this section). Confidential Information shall be clearly marked as such on each page or otherwise affirmatively identified. If a court, government agency or entity with the right, power, and authority to do so, requests or requires any Party, by subpoena, oral disposition, interrogatories, requests for production of documents, administrative order, or otherwise, to disclose Confidential Information, that Party shall provide the other Party with prompt notice of such request(s) or requirements(s) so that the other Party may seek an appropriate protective order or waive compliance with the provisions of this Interconnection Process and terms of the MN Interconnection Agreement. In the absence of a protective order or waiver the Party shall disclose such confidential information which, in the opinion of its counsel, the party is legally compelled to disclose. Each Party will use reasonable efforts to obtain reliable assurance that confidential treatment will be accorded to any confidential information furnished.

Critical infrastructure information or information that is deemed or otherwise designated by a Party as Critical Energy/Electric Infrastructure Information (CEII) pursuant to FERC regulation, [18 C.F.R. §388.133](#), as may be amended from time to time, may be subject to further protections for disclosure as required by FERC or FERC regulations or orders and the disclosing Party's CEII policies. Each Party shall employ at least the same standard of care to protect Confidential Information obtained from another Party as it employs to protect its own Confidential Information.

Each Party is entitled to equitable relief, by injunction or otherwise, to enforce its rights under this provision to prevent the release of Confidential Information without bond or proof of damages and may seek other remedies available at law or in equity for breach of this provision.

12.2. Non-Warranty

The Area EPS Operator and MRES does not give any warranty, expressed or implied, as to the adequacy, safety, or other characteristics of any structures, equipment, wires, appliances or devices owned, operated, installed or maintained by the Interconnection Customer, including without limitation the DER and any structures, equipment, wires, appliances or devices not owned, operated or maintained by the Area EPS Operator. The Area EPS Operator does not guarantee uninterrupted power supply to the DER and will operate the Distribution System with the same reliability standards for the entire customer base.

12.3. Indemnification

Each Party is protected from liability incurred to third parties as a result of carrying out the provisions of this Interconnection Process and associated MN Interconnection Agreement. The Parties shall at all times indemnify, defend, and save the other Party harmless from, any and all damages, losses, claims, including claims and actions relating to injury to or death of any person or damage to property, demand, suits, recoveries, costs and expenses, court costs, attorney fees, and all other obligations by or to third parties, arising out of or resulting from the other Party's action or inactions of its obligations on behalf of the indemnifying Party under this Interconnection Process or the MN Interconnection Agreement, except in cases of gross negligence or intentional wrongdoing by the indemnified Party.

This indemnification obligation shall apply notwithstanding any negligent or intentional acts, errors or omissions of the indemnified Party, but the indemnifying Party's liability to indemnify the indemnified Party shall be reduced in proportion to the percentage by which the indemnified Party's negligent or intentional acts, errors or omissions caused the damages.

Neither Party shall be indemnified for its damages resulting from its sole negligence, intentional acts or willful misconduct. These indemnity provisions shall not be construed to relieve any insurer of its obligation to pay claims consistent with the provisions of a valid insurance policy.

If an indemnified person is entitled to indemnification under this article as a result of a claim by a third party, and the indemnifying Party fails, after notice and reasonable opportunity to proceed under this article, to assume the defense of such claim, such indemnified person may at the expense of the indemnifying Party contest, settle or consent to the entry of any judgment with respect to, or pay in full, such claim.

If an indemnifying party is obligated to indemnify and hold any indemnified person harmless under this article, the amount owing to the indemnified person shall be the amount of such indemnified person's actual loss, net of any insurance or other recovery.

Promptly after receipt by an indemnified person of any claim or notice of the commencement of any action or administrative or legal proceeding or investigation as to which the indemnity provided for in this article may apply, the indemnified person shall notify the indemnifying party of such fact. Any failure of or delay in such notification shall not affect a Party's indemnification obligation unless such failure or delay is materially prejudicial to the indemnifying party.

12.4. Limitation of Liability

Each Party's liability to the other Parties for any loss, cost, claim, injury, liability, or expense, including reasonable attorney's fees, relating to or arising from any act or omission in its performance of its obligations under this Interconnection Process or the MN Interconnection Agreement shall be limited to the amount of direct damage actually incurred. In no event shall a party be liable to another party for any indirect, incidental, special, consequential, or punitive damages of any kind whatsoever, except as allowed under in Section 12.3. In addition, the Area EPS Operator's liability to Customer under this Interconnection Process or the MN Interconnection Agreement shall be further limited as set forth in the Area EPS Operator's tariffs and/or terms and conditions for electric service, which limitations are incorporated herein by this reference.

13 Glossary

Affected System – Another Area EPS Operator’s System, Transmission Owner’s Transmission System, or Transmission System connected generation which may be affected by the proposed interconnection.

Application Agent – A person designated in writing by the Interconnection Customer to represent or provide information to the Area EPS on the Interconnection Customer’s behalf throughout the interconnection process.

Area EPS – The electric power distribution system connected at the Point of Common Coupling.

Area EPS Operator – An entity that owns, controls, or operates the electric power distribution systems that are used for the provision of electric service in Minnesota. For this Interconnection Process the Area EPS Operator is [NAME OF LOCAL UTILITY]

Business Day – Monday through Friday, excluding Holidays as defined by Minn. Stat. §645.44, Subdivision 5. Any communication to have been sent or received after 4:30 p.m. Central Prevailing Time or on a Saturday, Sunday or holiday shall be considered to have been sent on the next Business Day.

Certified Equipment – Certified equipment is equipment that has been tested by a nationally recognized lab meeting a specific standard. For DER systems, a UL 1741 listing is a common form of DER inverter certification. Additional information is contained in Section 14 and the Minnesota Technical Requirements.

Confidential Information – Any confidential and/or proprietary information provided by one Party to another Party and is clearly marked or otherwise designated “Confidential.” All procedures, design, operating specifications, and metering data provided by the Interconnection Customer may be deemed Confidential Information. See Section 12.1 for further information.

DER Interconnection Coordinator – The person or persons designated by the AREA EPS Operator to provide a single point of coordination with the Interconnection Customer for the generation interconnection process.

Distributed Energy Resource (DER) – A source of electric power that is not directly connected to a bulk power system or central station service. DER includes both generators and energy storage technologies capable of exporting active power to an EPS. An interconnection system or a supplemental DER device that is necessary for compliance with this standard is part of a DER. For the purpose of the Interconnection Process and MN Interconnection Agreements, the DER includes the Interconnection Customer’s Interconnection Facilities but shall not include the Area EPS Operator’s Interconnection Facilities.

Distribution System – The Area EPS facilities which are not part of the Local EPS, Transmission System or any generation system.

Distribution Upgrades – The additions, modifications, and upgrades to the Distribution System at or beyond the Point of Common Coupling to facilitate interconnection of the DER and render the distribution service necessary to effect the Interconnection Customer’s connection to the Distribution System. Distribution Upgrades do not include Interconnection Facilities.

Electric Power System (EPS) – The facilities that deliver electric power to a load.

Fast Track Process – The procedure as described in the Interconnection Process - Fast Track Process for evaluating an Interconnection Application for a DER that meets the eligibility requirements of Section 3.4.

Force Majeure Event – An act of God, labor disturbance, act of the public enemy, war, insurrection, riot, fire, storm or flood, explosion, breakage or accident to machinery or equipment, an order, regulation or restriction imposed by governmental, military or lawfully established civilian authorities, or another cause beyond a Party’s control. A Force Majeure Event does not include an act of negligence or intentional wrongdoing.

Good Utility Practice – Any of the practices, methods and acts engaged in or approved by a significant portion of the electric industry during the relevant time period, or any of the practices, methods and act which, in the exercise of reasonable judgment in light of the facts known at the time the decision was made, could have been expected to accomplish the desired result at a reasonable cost consistent with good business practices, reliability, safety and expedition. Good Utility Practice is not intended to be limited to the optimum practice, method, or act to the exclusion of all others, but rather to be acceptable practices, methods, or acts generally accepted in the region.

Governmental Authority – Any federal, state, local or other governmental regulatory or administrative agency, court, commission, department, board, or other governmental subdivision, legislature, rulemaking board, tribunal, or other governmental authority having jurisdiction over the Parties, their respective facilities, or the respective services they provide, and exercising or entitled to exercise any administrative, executive, police, or taxing authority or power; provided, however, that such term does not include the Interconnection Customer, the Area EPS Operator, or any Affiliate thereof. The governing authority of the municipal Utility is the authority governing interconnection requirements unless otherwise provided for in the Minnesota Technical Requirements.

Interconnection and Power Purchase Agreement – 100 kW or Less (MN Standard Agreement)- The Area EPS Operator’s agreement for DER facilities that may be applied to all qualifying new and existing interconnections between the Area EPS Operator and a DER system having capacity 100 kilowatts or less. **MN Interconnection Agreement** – The terms and conditions between the Area EPS Operator and Interconnection Customer (Parties). See Section 8 for when the MN Standard Agreement or MN Interconnection Agreement applies.

Interconnection Application – The Simplified Application Form or Interconnection Application Form, as applicable, pursuant to Section 4.

Interconnection Customer – The person or entity, including the Area EPS Operator, who will be the owner of the DER and who proposes to interconnect a DER(s) with the Area EPS Operator’s Distribution System. The Interconnection Customer is responsible for ensuring the DER(s) is designed, operated and maintained in compliance with the Minnesota Technical Requirements.

Interconnection Facilities – The Area EPS Operator’s Interconnection Facilities and the Interconnection Customer’s Interconnection Facilities. Collectively, Interconnection Facilities include all facilities and equipment between the DER and the Point of Common Coupling, including any modification, additions or upgrades that are necessary to physically and electrically interconnect the DER to the Area EPS Operator’s System. Some examples of Customer Interconnection Facilities include: supplemental DER devices, inverters, and associated wiring and cables up to the Point of DER Connection. Some examples of Area EPS Operator Interconnection Facilities include sole use facilities; such as, line extensions, controls, relays, switches, breakers, transformers and shall not include Distribution Upgrades or Network Upgrades.

Interconnection Process – The Area EPS Operator’s interconnection standards in this document.

Material Modification – A modification to machine data, equipment configuration or to the interconnection site of the DER at any time after receiving notification by the Area EPS Operator of a complete Interconnection Application that has a material impact on the cost, timing, or design of any Interconnection Facilities or Upgrades, or a material impact on the cost, timing or design of any Interconnection Application with a later Queue Position or the safety or reliability of the Area EPS.⁶

⁶ A Material Modification shall include, but may not be limited to, a modification from the approved Interconnection Application that: (1) changes the physical location of the point of common coupling such that it is likely to have an impact on technical review; (2) increases the nameplate rating or output characteristics of the Distributed Energy Resource; (3) changes or replaces generating equipment, such as generator(s), inverter(s), transformers, relaying, controls, etc., and substitutes equipment that is not like-kind substitution in certification, size, ratings, impedances, efficiencies or capabilities of the equipment; (4) changes transformer connection(s) or grounding; and/or (5) changes to a certified inverter with different specifications or different inverter control settings or configuration. A Material Modification shall not include a modification from the approved Interconnection Application that: (1) changes the ownership of a Distributed Energy Resource; (2) changes the address of the Distributed Energy Resource, so long as the physical point of common coupling remains the same; (3) changes or replaces generating equipment such as generator(s), inverter(s), solar panel(s), transformers, relaying, controls, etc. and substitutes equipment that is a like-kind substitution in certification, size, ratings, impedances, efficiencies or capabilities of the equipment; and/or (4) increases the DC/AC ratio but does not increase the maximum AC output capability of the Distributed Energy Resource in a way that is likely to have an impact on technical review.

Minnesota Technical Requirements – The term includes all of the DER technical interconnection requirement documents, including the Technical Specifications Manual adopted by the Area EPS Operator (Chapter 8 of the DG Workbook – MN) and the Minnesota Technical Interconnection and Interoperability Requirements approved by the Minnesota Public Utilities Commission in Docket No. E-999/CI-16-521.

Nameplate Rating – nominal voltage (V), current (A), maximum active power (kWac), apparent power (kVA), and reactive power (kVar) at which a DER is capable of sustained operation. For a Local EPS with multiple DER units, the aggregate nameplate rating is equal to the sum of all DERs nameplate rating in the Local EPS. As described in Section 6.3, the DER system’s capacity may, with the Area EPS’s agreement, be limited through use of control systems, power relays or similar device settings or adjustments as identified in IEEE 1547. The nameplate ratings referenced in the Interconnection Process are alternating current nameplate DER ratings at the Point of DER Connection.

Network Upgrades – Additions, modifications, and upgrades to the Transmission System required at or beyond the point at which the DER interconnects with the Area EPS Operator’s System to accommodate the interconnection with the DER to the Area EPS Operator’s System. Network Upgrades do not include Distribution Upgrades.

Operating Requirements – Any operating and technical requirements that may be applicable due to the Transmission Provider’s technical requirements or the Minnesota Technical Requirements, including those set forth in the MN Interconnection Agreement.

Party or Parties – The Area EPS Operator and the Interconnection Customer. For purposes of the MN Standard Agreement, “Party or Parties” will also include Missouri River Energy Services.

Point of Common Coupling (PCC) – The point where the Interconnection Facilities connect with the Area EPS Operator’s Distribution System. See figure 1. Equivalent, in most cases, to “service point” as specified by the Area EPS Operator and described in the National Electrical Code and the National Electrical Safety Code.

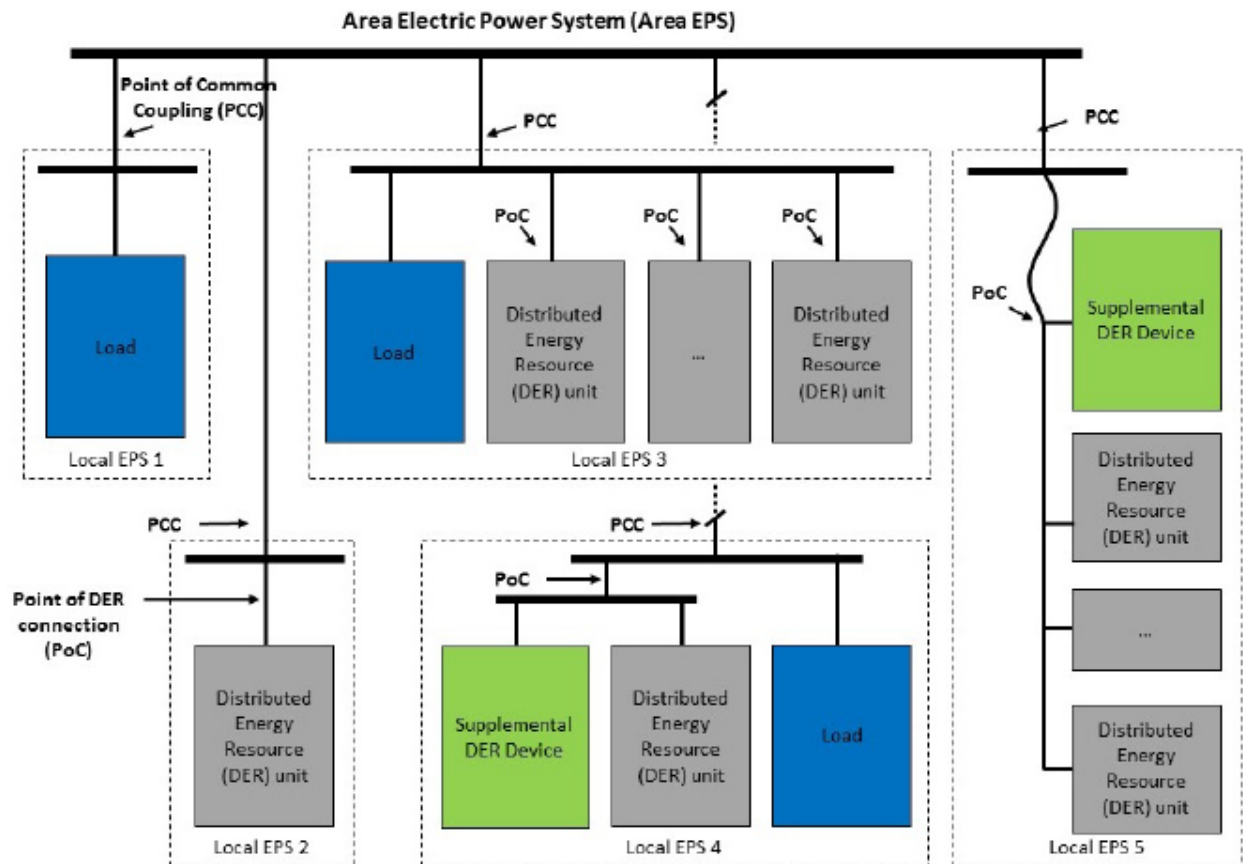

Figure 1: Point of Common Coupling and Point of DER Connection

(Source: IEEE 1547)

Point of DER Connection (PoC) – When identified as the Reference Point of Applicability, the point where an individual DER is electrically connected in a Local EPS and meets the requirements of this standard exclusive of any load present in the respective part of the Local EPS (e.g. terminals of the inverter when no supplemental DER device is required). For DER unit(s) that are not self-sufficient to meet the requirements without a supplemental DER device(s), the Point of DER Connection is the point where the requirements of this standard are met by DER in conjunction with a supplemental DER device(s) exclusive of any load present in the respective part of the Local EPS.

Queue Position – The order of a valid Interconnection Application, relative to all other pending valid Interconnection Applications, that is established based upon the date- and time- of receipt of the complete Interconnection Application as described in Section 4.7.

Reasonable Efforts – With respect to an action required to be attempted or taken by a Party under these procedures, efforts that are timely and consistent with Good Utility Practice and are otherwise substantially equivalent to those a Party would use to protect its own interests.

Reference Point of Applicability – The location, either the Point of Common Coupling or the Point of DER Connection, where the interconnection and interoperability performance requirements specified in IEEE 1547 apply. With mutual agreement, the Area EPS Operator and Customer may determine a point between the Point of Common Coupling and Point of DER Connection. See Minnesota Technical Requirements for more information.

Simplified Process – The procedure for evaluating an Interconnection Application for a certified inverter-based DER no larger than 20 kW that uses the screens described in the Interconnection Process – Simplified Process document. The Simplified Process includes simplified procedures.

Study Process – The procedure for evaluating an Interconnection Application that includes the scoping meeting, system impact study, and facilities study.

Transmission Owner – The entity that owns, leases or otherwise possesses an interest in the portion of the Transmission System relevant to the Interconnection.

Transmission Provider – The entity (or its designated agent) that owns, leases, controls, or operates transmission facilities used for the transmission of electricity. The term Transmission Provider includes the Transmission Owner when the Transmission Owner is separate from the Transmission Provider. The Transmission Provider may include the Independent System Operator or Regional Transmission Operator.

Transmission System – The facilities owned, leased, controlled or operated by the Transmission Provider or the Transmission Owner that are used to provide transmission service. See the Minnesota Public Utilities Commission’s July 26, 2000 Order Adopting Boundary Guidelines for Distinguishing Transmission from Generation and Distribution Assets in Docket No. E-999/CI-99-1261.

Upgrades – The required additions and modifications to the Area EPS Operator’s Transmission or Distribution System at or beyond the Point of Interconnection. Upgrades may be Network Upgrades or Distribution Upgrades. Upgrades do not include Interconnection Facilities.

14 Certification of DER Equipment

Distributed Energy Resource (DER) equipment proposed for use in an interconnection system shall be considered certified for interconnected operation if the following criteria is met:

- 1) It has been tested in accordance with industry standards for continuous utility interactive operation in compliance with the appropriate codes and standards referenced below by any Nationally Recognized Testing Laboratory (NRTL) recognized by the United States Occupational Safety and Health Administration to test and certify interconnection equipment pursuant to the relevant codes and standards listed in the Process Overview,
- 2) It has been labeled and is publicly listed by such NRTL at the time of the interconnection application, and
- 3) Such NRTL makes readily available for verification all test standards and procedures it utilized in performing such equipment certification, and, with consumer approval, the test data itself. The NRTL may make such information available on its website and by encouraging such information to be included in the manufacturer's literature accompanying the equipment.

The Interconnection Customer must verify that the assembly and use of the equipment falls within the use or uses for which the equipment was tested, labeled, and listed by the NRTL.

Certified equipment shall not require further type-test review, testing, or additional equipment to meet the requirements of this interconnection procedure; however, nothing herein shall preclude the need for a DER Design Evaluation or an on-site commissioning test by the parties to the interconnection as provided for in the Minnesota Technical Requirements.

If the certified equipment package includes only interface components (switchgear, inverters, or other interface devices), then an Interconnection Customer must show that the generator or other electric source being utilized with the equipment package is compatible with the equipment package and is consistent with the testing and listing specified for this type of interconnection equipment.

Provided the generator or electric source, when combined with the equipment package, is within the range of capabilities for which it was tested by the NRTL and does not violate the interface components' labeling and listing performed by the NRTL, no further type-test review, testing or additional equipment on the customer side of the Point of Common Coupling shall be required to be considered certified for the purposes of this interconnection procedure; however, nothing herein shall preclude the need for a DER design evaluation or an on-site

commissioning test by the parties to the interconnection as provided for in the Minnesota Technical Requirements.

An equipment package does not include equipment provided by the Area EPS.

Interconnection Process Timelines

Review of Simplified Application

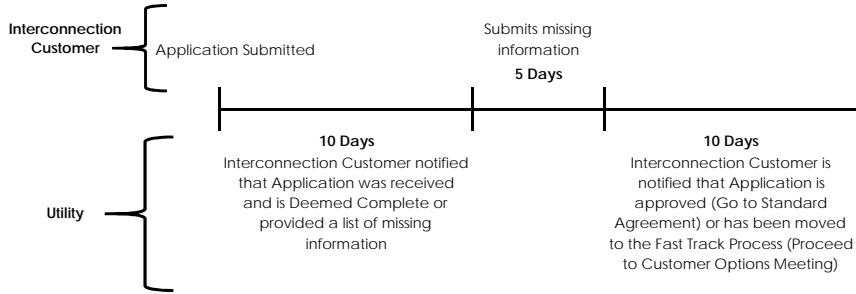

Review of Fast Track Application

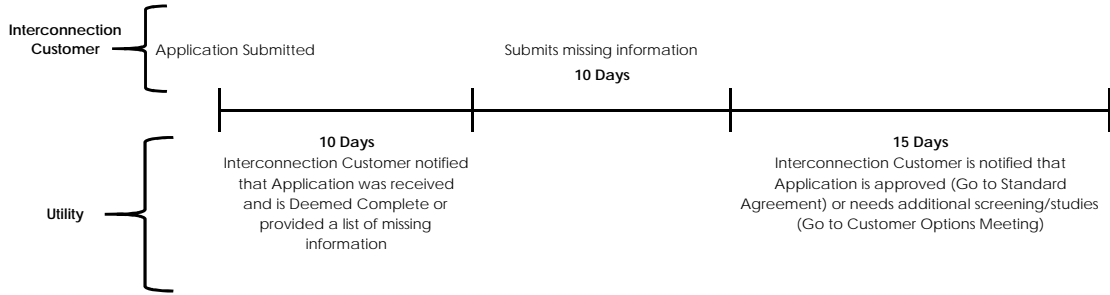

Review of Study Process Application

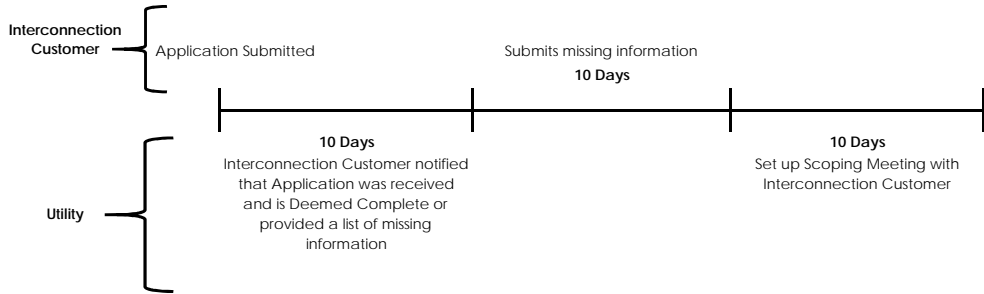

Standard Agreement or Interconnection Agreement

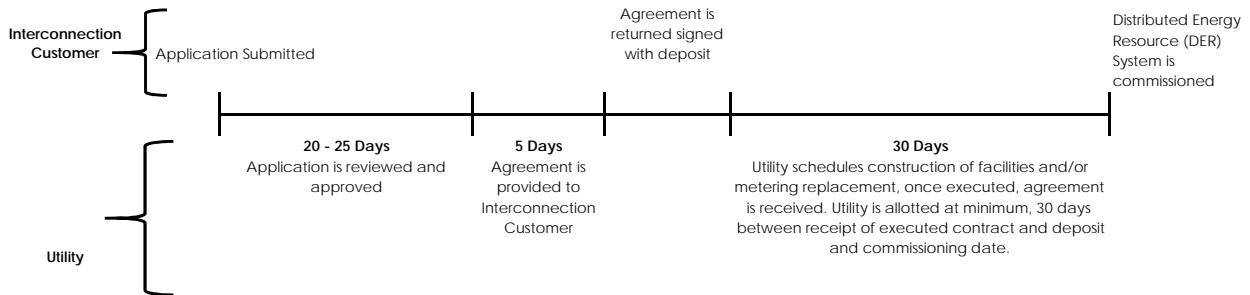

Customer Options Meeting and Supplemental Review Screens

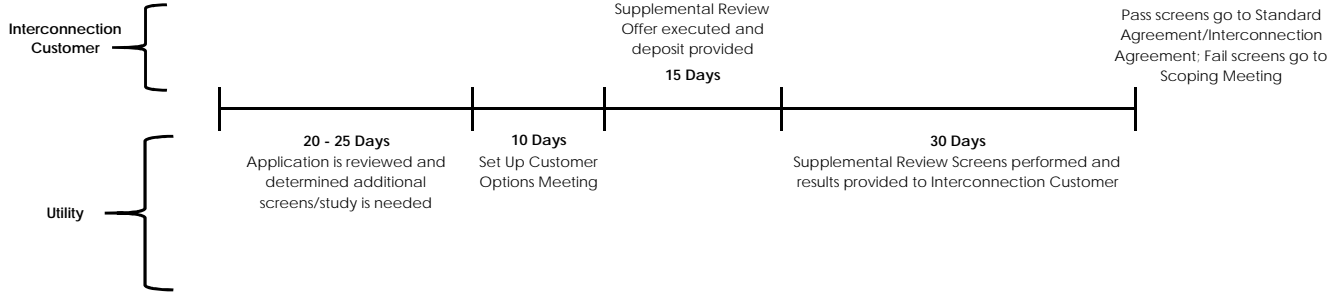

Scoping Meeting and System Impact Study

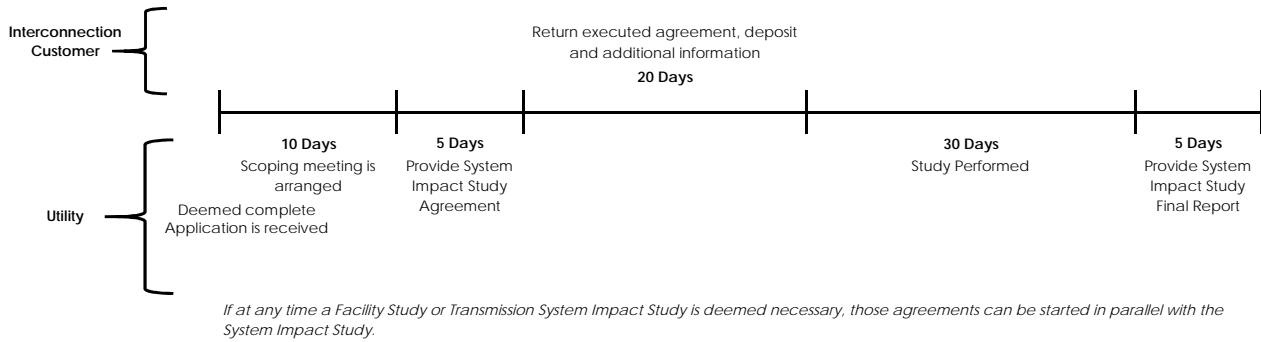

Facility Study

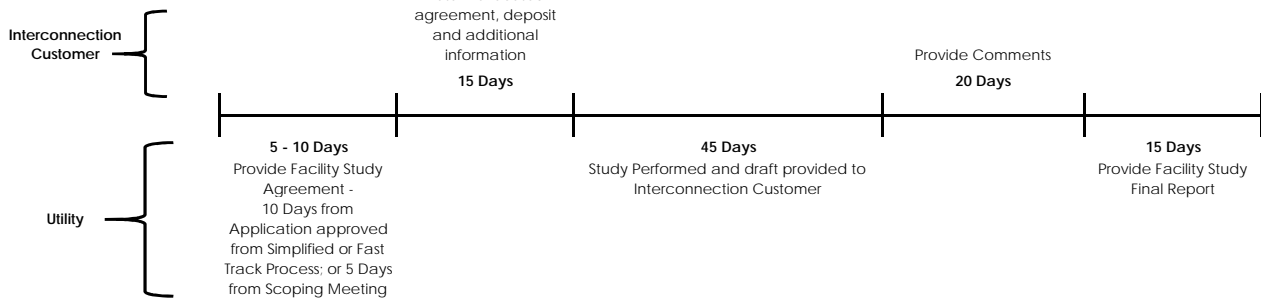

INTERCONNECTION PROCESS

Simplified Process

SUMMARY

Information in addition to the "Process Overview" for interconnecting a Distributed Energy Resource of 20 kW or less to the utility distribution system.

Contents

1	Applicability	1
1.1.	Capacity Limit	1
1.2.	Certified Inverters	1
2	Application Submission	1
2.1.	Simplified Process Application	1
2.2.	Battery Storage	2
2.3.	Site Control.....	2
3	Application Review	2
3.1.	Timelines	2
3.2.	Initial Review Screens.....	3
3.3.	Notification of Approval of Application	4
3.4.	Failure of Review Screens	5
4	MN Interconnection Agreement	5
4.1.	MN Standard Agreement	5
4.2.	MN Interconnection Agreement.....	5
4.3.	Completion of Agreement.....	5
5	Insurance	6
5.1.	Insurance Requirements	6
5.2.	Proof of Insurance	6
6	Timeline Extensions	6
6.1.	Reasonable Efforts	6
6.2.	Extensions	7
7	Modifications to Application	7
7.1.	Procedures	7
7.2.	Timelines	7
8	Interconnection	8
8.1.	Metering.....	8
8.2.	Construction.....	8
8.3.	Inspection, Testing and Commissioning.....	8

8.4.	Interconnection Costs	9
8.5.	Authorization for Parallel Operation.....	10
8.6.	Continual Compliance	10
8.7.	Disconnection of DER.....	10

1 Applicability

1.1. Capacity Limit

The Simplified Process only is applicable to certified inverter-based Distributed Energy Resource (DER) systems with the capacity of 20 kW AC or less. The capacity is determined by the aggregated summation of the Nameplate Rating of the inverters that make up the DER system. Additional information regarding the capacity limits can be seen in Chapter 4, the MN Interconnection Process Overview document.

1.2. Certified Inverters

A certified inverter will have certification of meeting the current version of the IEEE standard 1547. A common inverter certification is UL 1741. Note that certified inverters may still need to have a setting adjusted to meet the technical requirements of the Area EPS Operator. Additional information regarding certified equipment is found in Section 14 of the Interconnection Process Overview document and the Minnesota Technical Requirements.

2 Application Submission

2.1. Simplified Process Application

The Interconnection Customer shall complete the Simplified Interconnection Application and submit it to the Area EPS Operator to initialize the Interconnection Process. A completed Simplified Interconnection Application will include the following:

- A completed Simplified Interconnection Application signed by the Interconnection Customer,
- A non-refundable processing fee of \$100,
- An aerial site layout drawing of the proposed DER system,
- A one-line diagram of the proposed DER system showing the point of common coupling (PCC) to the Area EPS Operator's Distribution System, and
- All certified equipment manufacturer specification sheets.

2.2. Battery Storage

An inverter-based DER system may include battery storage. DER systems that include battery storage must also complete the Energy Storage Application with the Simplified Interconnection Application.

2.3. Site Control

By signing the Simplified Interconnection Application, the Interconnection Customer is indicating that the proposed DER system is being located where the Interconnection Customer has site control. Site control includes ownership of, a leasehold interest in, or a right to develop a site for the purpose of construction of a DER. Additional information regarding site control can be reviewed in the Process Overview document in Section 4.8.

3 Application Review

3.1. Timelines

The Interconnection Application shall be date- and time-stamped upon initial, and if necessary, resubmission receipt. The Interconnection Customer shall be notified of receipt by the Area EPS Operator within ten (10) Business Days of receipt of the Interconnection Application.

The Area EPS Operator shall notify the Interconnection Customer if the Interconnection Application is deemed incomplete within ten (10) Business Days and provide a written list detailing all information that must be provided to complete the Interconnection Application. The Interconnection Customer has five (5) Business Days to provide the missing information unless the Interconnection Customer submits a valid request for a timeline extension. Failure to submit the requested information within the stated timeline will deem the Interconnection Application withdrawn. The Area EPS Operator has an additional five (5) Business Days to review the additionally provided information for completeness.

An Interconnection Application will be deemed complete upon submission to the Area EPS Operator provided all documents, fees and information required with the Interconnection Application adhering to the Minnesota Technical Requirements are included. The time- and date- stamp of the completed Interconnection Application shall be accepted as the qualifying date for the purpose of establishing a queue position as described in Section 4.7 of the Overview Process document.

The Area EPS Operator has a total of twenty (20) Business Days to complete the Interconnection Application review from the receipt of a completed Interconnection

Application and submit notice back to the Interconnection Customer stating the proposed DER system may proceed with the interconnection process or the proposed DER system has been moved into a different process track. The time during which the Interconnection Customer provides missing information is not included in the Area EPS Operator's twenty (20) Business Days review timeline.

3.2. Initial Review Screens

The Area EPS Operator shall determine if the DER can be interconnected safely and reliably using Initial Review Screens and without the construction of facilities by the Area EPS Operator. The Initial Review Screens include the following engineering screens:

- The proposed DER's PCC must be on a portion of the Area EPS Operator's Distribution System.
- For interconnection of a proposed DER to a radial distribution circuit, the aggregated generation, including the proposed DER, on the circuit shall not exceed 15% of the line section annual peak load as most recently measured or 100% of the substation aggregated minimum load. A line section is that portion of an Area EPS Operator's electric system connected to a customer bounded by automatic sectionalizing devices or the end of the distribution line. The Area EPS Operator may consider 100% of applicable loading (i.e. daytime minimum load for solar), if available, instead of 15% of line section peak load.
- For interconnection of a proposed DER to the load side of network protectors, the proposed DER must utilize an inverter-based equipment package and, together with the aggregated other inverter-based DERs, shall not exceed the smaller of 5% of a network's maximum load or 50 kW.¹
- The proposed DER, in aggregation with other DERs on the distribution circuit, shall not contribute more than 10% to the distribution circuit's maximum fault current at the point on the high voltage (primary) level nearest the proposed PCC.
- The proposed DER, in aggregate with other Distributed Energy Resources on the distribution circuit, shall not cause any distribution protective devices and equipment (including, but not limited to, substation breakers, fuse cutouts, and

¹ Network protectors are protective devices used on secondary networks (spot and grid networks) to automatically disconnect its associated transformer when reverse power flow occurs. Secondary networks are most often used in densely populated downtown areas.

line reclosers), or Interconnection Customer equipment on the system to exceed 87.5% of the short circuit interrupting capability; nor shall the interconnection be proposed for a circuit that already exceeds 87.5% of the short circuit interrupting capability.

- Using the table below, determine the type of interconnection to a primary distribution line. This screen includes a review of the type of electrical service provided to the Interconnecting Customer, including line configuration and the transformer connection to limit the potential for creating over-voltages on the Area EPS Operator’s electric power system due to a loss of ground during the operating time of any anti-islanding function.

Primary Distribution Line Type	Type of Interconnection to Primary Distribution Line	Results
Three-Phase, three wire	Three-phase or single-phase, phase-to-phase	Pass Screen
Three-phase, four wire	Effectively-grounded three-phase or single-phase, line-to-neutral	Pass Screen

- If the proposed DER is to be interconnected on single-phase shared secondary, the aggregate generation capacity on the shared secondary, including the proposed DER, shall not exceed 20 kW or 65% of the transformer nameplate rating.
- If the proposed DER is single-phase and is to be interconnected on a center tap neutral of a 240-volt service, its addition shall not create an imbalance between the two sides of the 240-volt service of more than 20% of the nameplate rating of the service transformer.

The technical screens listed shall not preclude the Area EPS Operator from using tools that perform screening functions using different methodologies given the analysis is aimed at preventing the voltage, thermal and protection limitations as the listed screen.

3.3. Notification of Approval of Application

Provided the Simplified Interconnection Application passes the initial screens, or if the proposed interconnection fails the screens but the Area EPS Operator determines that the DER may never the less be interconnected consistent with safety, reliability and power quality standards, the Area EPS Operator shall provide notice to the Interconnection Customer that their Simplified Interconnection Application has been approved.

3.4. Failure of Review Screens

If the proposed interconnection fails the screens, the Interconnection Customer will be notified by the Area EPS Operator that the Simplified Interconnection Application has been moved to the Fast Track Process. The Area EPS Operator shall provide the Interconnection Customer the opportunity to attend a customer options meeting. Additional information regarding the customer options meeting is found in Section 3.5 of the Fast Track Process document. The Interconnection Customer will need to provide a completed Interconnection Application to the Area EPS Operator prior to, or at the customer options meeting.

The Area EPS Operator shall notify the Interconnection Customer of the determination and provide copies of all directly pertinent data and analyses underlying its conclusion, subjected to confidentiality provisions in Section 12.1 of the Process Overview document.

4 MN Interconnection Agreement

4.1. MN Standard Agreement

The Area EPS Operator shall provide the Interconnection Customer with an executable copy of the MN Standard Agreement within five (5) Business Days of notice of approval of the Simplified Interconnection Application.

4.2. MN Interconnection Agreement

The Interconnection Customer may request on the Simplified Interconnection Application an executable copy of the Area EPS Operator's MN Interconnection Agreement in lieu of signing the MN Standard Agreement. If the MN Interconnection Agreement is requested, the Area EPS Operator shall provide an executable copy of the MN Interconnection Agreement within five (5) Business Days of notice of approval of the Simplified Interconnection Application.

4.3. Completion of Agreement

The Interconnection Customer must return a signed MN Standard Agreement or MN Interconnection Agreement thirty (30) Business Days prior to a requested in-service date of the proposed DER. The Area EPS Operator shall sign and return a copy of the fully executed MN Standard Agreement or the MN Interconnection Agreement back to the Interconnection Customer.

The Interconnection Customer may update the requested in-service date submitted on the Simplified Interconnection Application to a date thirty (30) Business Days or later from the date on which the Interconnection Customer submits a signed MN Standard

Agreement or MN Interconnection Agreement and payment if required unless the Area EPS Operator agrees to an earlier date.

Upon receipt of the signed MN Standard Agreement or MN Interconnection Agreement, the Area EPS Operator may schedule appropriate metering replacements and construction of facilities, if necessary.

5 Insurance

5.1. Insurance Requirements

At minimum, the Interconnection Customer shall maintain, for the duration the DER system is interconnected to the Area EPS Operator's Distribution System, \$300,000 of general liability insurance from a qualified insurance agency with a B+ or better rating by "Best." Such general liability insurance shall include coverage against claims for damages resulting from (i) bodily injury, including wrongful death; and (ii) property damage arising out of the Interconnection Customer's ownership and/or operation of the DER under this agreement. Evidence of the insurance shall state that coverage provided is primary and is not excess to or contributing with any insurance or self-insurance by the Area EPS Operator.

5.2. Proof of Insurance

Prior to initial operation of the DER, the Interconnection Customer shall furnish the Area EPS Operator with the Declarations page of the Homeowner's insurance policy documenting insurance of the DER, if applicable or other insurance certificates and endorsements documenting insurance. Thereafter, the Area EPS Operator shall have the right to periodically inspect or obtain a copy of the original policy or policies of insurance. Additionally, the Area EPS Operator may request to be additionally listed as an interested third party on the insurance certificates and endorsements to meet the right to periodically obtain a copy of the policy or policies of insurance.

6 Timeline Extensions

6.1. Reasonable Efforts

The Area EPS Operator shall make Reasonable Efforts to meet all time frames provided in these procedures. If the Area EPS Operator cannot meet a deadline provided herein, it must notify the Interconnection Customer in writing within three (3) Business Days after the deadline to explain the reason for the failure to meet the deadline and provide an estimated time by which it will complete the applicable interconnection procedure in the process.

6.2. Extensions

For applicable time frames described in these procedures, the Interconnection Customer may request, in writing, one extension equivalent to half of the time originally allotted (e.g. ten (10) Business Days for a twenty (20) Business Days original time frame) which the Area EPS Operator may not unreasonably refuse. No further extensions for the applicable time frame shall be granted absent a Force Majeure Event or other similarly extraordinary circumstance.

7 Modifications to Application

7.1. Procedures

At any time after the Interconnection Application is deemed complete, the Interconnection Customer or the Area EPS Operator may identify modifications to the proposed DER system that may improve costs and benefits (including reliability) of the proposed DER system and the ability for the Area EPS Operator to accommodate the proposed DER system. The Interconnection Customer shall submit to the Area EPS Operator in writing all proposed modifications to any information provided in the Interconnection Application. The Area EPS Operator cannot unilaterally modify the Interconnection Application.

7.2. Timelines

Within ten (10) Business Days of receipt of the proposed modification, the Area EPS Operator shall evaluate whether the proposed modification to the Interconnection Application constitutes a Material Modification. The definition of Material Modification in Section 13 Glossary of the Process Overview document includes examples of what does and does not constitute a Material Modification.

The Area EPS Operator shall notify the Interconnection Customer in writing of the final determination of the proposed modification. For proposed modifications that are determined to be a Material Modification, the Interconnection Customer may choose to either: 1) withdraw the proposed modification; or 2) proceed with a new Interconnection Application. The Interconnection Customer shall provide its determination in writing to the Area EPS Operator within ten (10) Business Days after being provided the Material Modification determination. If the Interconnection Customer does not provide its determination within the timeline, the Interconnection Application shall be considered withdrawn.

If the proposed modification is not determined to be a Material Modification, then the Area EPS Operator shall notify the Interconnection Customer in writing that the

modification has been accepted and the Interconnection Customer shall retain its eligibility for interconnection, including its place in the queue.

8 Interconnection

8.1. Metering

Any metering requirements necessitated by the use of the DER system shall be installed at the Interconnection Customer's expense. The metering requirement costs will be included in a final invoice of interconnection costs to the Interconnection Customer. The Interconnection Customer is also responsible for metering replacement costs not covered in the Interconnection Customer's general customer charge. The Area EPS Operator may charge Interconnection Customers an ongoing metering-related charge for an estimate of ongoing metering-related costs specifically demonstrated.

8.2. Construction

The Interconnection Customer may proceed to construct (including operational testing not to exceed two hours) the DER system when the Area EPS Operator has approved the Simplified Interconnection Application. Upon receipt of a signed MN Standard Agreement or MN Interconnection Agreement the Area EPS Operator shall schedule and execute appropriate construction of facilities, if necessary, which shall be completed prior to the Interconnection Customer returning the Certification of Completion. The Area EPS Operator will notify the Interconnection Customer when construction of the distribution facilities is completed.

8.3. Inspection, Testing and Commissioning

Upon completing construction of the DER system, the Interconnection Customer will cause the DER system to be inspected or otherwise certified by the appropriate local electrical wiring inspector with jurisdiction. The Interconnection Customer shall then arrange for the inspection and testing of the DER system and the Customer's Interconnection Facilities prior to interconnection pursuant to the Minnesota Technical Requirements. Commissioning tests of the Interconnection Customer's installed equipment shall be performed pursuant to applicable codes and standards identified in the Minnesota Technical Requirements. The Interconnection Customer shall provide the Area EPS Operator with a Certification of Completion after completion of the DER installation.

Prior to parallel operation, the Area EPS Operator may inspect the DER for compliance with standards, which may include a witness test, and schedule appropriate metering replacements, if necessary. The Area EPS Operator shall send qualified personnel to the

DER site to inspect the interconnection and witness the testing, but the Area EPS Operator bears no liability for the results of the test.

The Area EPS Operator is obligated to complete the witness test, if required, within ten (10) Business Days of receipt of the Certification of Completion. If the Area EPS Operator does not inspect within ten (10) Business Days, the witness test is deemed waived unless upon mutual agreement of both Parties to extend the timeline for the witness test.

Within three (3) Business Days of satisfactory inspection or waiver of inspection, the Area EPS Operator shall provide the Interconnection Customer written acknowledgment that the DER has permission to operate. Such written acknowledgment shall not be deemed to be or construed as any representation, assurance, guarantee, or warranty by the Area EPS Operator of the safety, durability, suitability, or reliability of the DER or any associated control, protective, and safety devices owned or controlled by the Interconnection Customer or the quality of power produced by the DER.

If the witness test is not satisfactory, the Area EPS Operator has the right to disconnect the DER. The Interconnection Customer has no right to operate in parallel, except for optional testing not to exceed two hours, until permission to operate is granted by the Area EPS Operator.

8.4. Interconnection Costs

The Interconnection Customer shall pay for the actual cost of the Interconnection Facilities and Distribution Upgrades along with the Area EPS Operator's cost to commission the proposed DER system. An estimate of the interconnection costs shall be stated in the MN Standard Agreement or MN Interconnection Agreement. The Area EPS Operator shall render the final interconnection cost invoice to the Interconnection Customer within thirty (30) Business Days after the proposed DER system has been commissioned by the Area EPS Operator, or upon the commissioning being waived by the Area EPS Operator. The Interconnection Customer shall make payment to the Area EPS Operator within twenty-one (21) Business Days of receipt, or as otherwise stated in the MN Standard Agreement.

The Area EPS Operator does not give any warranty, expressed or implied, as to the adequacy, safety, or other characteristics of any structures, equipment, wires, appliances or devices owned, operated, installed or maintained by the Interconnection Customer, including without limitation the DER and any structures, equipment, wires, appliances or devices not owned, operated or maintained by the Area EPS Operator.

8.5. Authorization for Parallel Operation

The Interconnection Customer shall not operate its DER system in parallel with the Area EPS Operator's Distribution System without prior written authorization from the Area EPS Operator. The Area EPS Operator shall provide such authorization within three (3) Business Days from when the Area EPS Operator receives the Certificate of Completion and notification the Interconnection Customer has complied with all applicable parallel operations requirements. Such authorization shall not be unreasonably withheld, conditioned or delayed.

8.6. Continual Compliance

The Interconnection Customer shall be fully responsible to operate, maintain, and repair the DER as required to ensure that it complies at all times with the interconnection standards to which it has been certified. The Interconnection Customer shall also operate its DER system in compliance with the Area EPS Operator's technical requirements as referred to in the executed MN Standard Agreement or MN Interconnection Agreement. The Area EPS Operator may periodically inspect, at its own expense, the operation of DER system as it relates to power quality, thermal limits and reliability. Failure by the Interconnection Customer to remain in compliance with the Minnesota Technical Requirements will result in the DER system's disconnection from the Area EPS Operator's Distribution System.

8.7. Disconnection of DER

The Area EPS Operator has the right to disconnect the DER in the event of the following:

- The Interconnection Customer does not continue to follow and maintain IEEE 1547 settings or functions as required by the Minnesota Technical Requirements.
- The DER does not meet all the requirements of the Simplified Process.
- The Interconnection Customer refuses to sign either the MN Interconnection Agreement or the Area EPS Operator's MN Standard Agreement.

The Area EPS Operator may temporarily disconnect the DER upon the following conditions:

- For scheduled outages upon reasonable notice.
- For unscheduled outages or emergency conditions.

- If the DER does not operate in a manner consistent with the Simplified Process.

The Area EPS Operator shall inform the Interconnection Customer in advance of any scheduled disconnections, or as reasonable, after an unscheduled disconnection.

Simplified Interconnection Application

Persons interested in applying for the interconnection of a distributed energy resource (DER) to the Local Utility’s distribution system through the Simplified Process are to fill out this Simplified Interconnection Application. The Simplified Interconnection Application is to be used for inverter-based DER technologies with the capacity of 20 kW AC or less and is to be filled out completely by the Applicant. The Simplified Application shall be returned to the Local Utility with the requested material information and a non-refundable \$100 application fee.

Proposed DER interconnections to the Local Utility’s distribution system submitted under the Simplified Process may be moved into the Fast Track Process if engineering screens are failed during the Simplified Interconnection Application review. Timeline for review of the Simplified Application is as follows:

- Upon receipt of a Simplified Interconnection Application the Local Utility has 10 business days to review the application for completeness.
- If the application is deemed incomplete, the Local Utility shall notify the Applicant of what additional information material is required.
- The Applicant has 5 business days to return the missing information material or their application may lose its queue position and be deemed withdrawn.
- The Local Utility shall have a total of 20 business days to review the Simplified Interconnection Application, not including time waiting for additional information material to deem the application completed.
- The Local Utility will notify the Applicant if the proposed DER system is preliminary approved for interconnection or if the proposed DER system will need to be moved into the Fast Track Process.

Checklist for Submission to Local Utility	
<i>The items below shall be included with submittal of the Simplified Application to the Local Utility. Failure to include all items will deem the Simplified Application incomplete.</i>	
	Included
\$100 Non-Refundable Simplified Application Fee	<input type="checkbox"/> Yes
One-line diagram – Details required on one-line diagram specified at the end of the interconnection application and in Local Utility’s Technical Specifications Manual (TSM)	<input type="checkbox"/> Yes
All Certified Equipment Manufacturer Specification Sheets	<input type="checkbox"/> Yes
Site Layout Drawing (See TSM for more details)	<input type="checkbox"/> Yes
Copy of Insurance Declaration page or other acceptable proof of insurance	<input type="checkbox"/> Yes
<u>Possible Additional Documentation (See TSM for more details)</u>	
<ul style="list-style-type: none"> • If an Application Agent is being used for this project, the Site Layout Drawing must be signed by the Interconnection Customer indicating Site Control of the DER interconnection location. • If the DER export capacity is limited, include information material explaining the limiting capabilities. • If Energy Storage is included with the proposed DER system include the Energy Storage Application. 	

Simplified Interconnection Application

Interconnection Customer		
Full Name (must match the name of the existing service account):		
Account Number:	Meter Number:	
Mailing Address:		
City:	State:	Zip Code:
Email:	Phone:	

Application Agent	
Is the Customer using an Application Agent for this application?	<input type="checkbox"/> Yes <input type="checkbox"/> No
<i>If Interconnection Customer is not using an Application Agent, please skip to the next section.</i>	
Application Agent:	
Company Name:	
Email:	Phone:

For Office Use Only	
Application ID:	Queue Number:
Date Received:	Application Fee Received: <input type="checkbox"/> Yes <input type="checkbox"/> No
Date Preliminary Approval Provided to Applicant:	

Interconnection Agreement

Proposed DER interconnections that are also deemed Qualifying Facilities under Minnesota Statutes § 216B.164 are eligible to sign the Local Utility's Standard Agreement. Included in this agreement are payment terms for excess power generated by the proposed DER system the Local Utility may purchase. In lieu of the Local Utility's Standard Agreement, the Interconnection Customer may choose to instead sign the Local Utility's Interconnection Agreement.

The Interconnection Customer requests an Interconnection Agreement to be executed in lieu of the Local Utility's Standard Agreement.

Yes No

Disclaimers – Must be completed by Interconnection Customer

Initials

The Interconnection Customer has opportunities to request a timeline extension during the interconnection process. Failure by the Interconnection Customer to meet or request an extension for a timeline outlined in the Interconnection Process could result in a withdrawn queue position and the need to re-apply.

Proposed DER interconnection to the Local Utility's distribution system submitted under the Simplified Process may be moved into the Fast Track Process if engineering screens are failed during the Simplified Application review.

Application Signature – Must be completed by Interconnection Customer

I designate the individual or company listed as my Application Agent to serve as my agent for the purpose of coordinating with the Area EPS Operators on my behalf throughout the interconnection process.

Initials

I hereby certify that, to the best of my knowledge, the information provided in this Application is true, and that I have appropriate Site Control in conformance with the Interconnection Process. I agree to abide by the Minnesota Interconnection Process (MIP) and return the Certificate of Completion when the DER has been installed.

Applicant Signature:

Date:

*****Please print clearly or type and return completed along with any additional documentation*****

Information Required on One-Line Diagram

An Interconnection Application must include a site electrical one-line diagram showing the configuration of all Distributed Energy Resource equipment, current and potential circuits, and protection and control schemes. The one-line diagram shall include:

- Applicant name.
- Application ID.
- Installer name and contact information.
- Address where DER system will be installed - must match application address.
 - Be sure to list the address for the protective interface equipment if the protective interface equipment is located at a different address than the DER system.
- Correct positions of all equipment, including but not limited to panels, inverter, and DC/AC disconnect. Include distances between equipment, and any labeling found on equipment.
- Any other information that may be required by the Local Utility's Technical Specifications Manual

Please see the Local Utility's Technical Specifications Manual for example one-line diagram.

Certification of Completion

The Interconnection Customer should complete the Distributed Energy Resource Certification of Completion for a proposed DER interconnection in the Simplified Process Track. As a condition of interconnection, a completed copy of this form must be returned to the Local Utility.

Distributed Energy Resource Information		
Interconnection Customer:		
DER Project Address:		
City:	State:	Zip Code:
Application ID:	Meter Number:	
Is the DER system owner-installed?	<input type="checkbox"/> Yes <input type="checkbox"/> No (If no, please complete Installer Information)	

Installer Information	
Contact Name:	
Name of Business:	
Email:	Phone:
Electrician Name	License #

Electrical Permitting Authority	
<i>The DER has been installed and inspected in compliance with the local electrical permitting authority as verified by the signature below or the additionally attached document.</i>	
Inspector Signature:	Date:
Inspector Name:	Authority Having Jurisdiction (city/county):

For Office Use Only
Date Received:

**INTERCONNECTION AND POWER PURCHASE AGREEMENT –
100 kW or Less (MN STANDARD AGREEMENT)**

This Interconnection and Power Purchase Agreement – 100 kW or Less (MN Standard Agreement) (the “Agreement”) is made and entered into _____, 20__, by and among Missouri Basin Municipal Power Agency, d/b/a Missouri River Energy Services, 3724 West Avera Drive, PO Box 88920, Sioux Falls, SD 57109-8920, a body politic and corporate and public agency organized in Iowa and existing under the laws of the States of Iowa, Minnesota, North Dakota and South Dakota (“MRES”), _____, [Address] (“Local Utility”), and _____, with an address as set forth in Exhibit A hereto (“Customer”). MRES, Local Utility and Customer are each individually referred to herein as a “Party” and collectively as the “Parties.”

RECITALS

A. Customer has installed, or plans to install, electric generating facilities rated at 100 kilowatts or less of electricity on certain real property owned or leased by Customer, which facilities and property are more particularly described in the MN Interconnection Application attached to this Agreement as Exhibit A. The generating facilities are hereinafter referred to as the “Qualifying Facility”.

B. Local Utility is a municipal utility that owns and operates an electrical distribution system (the “Local Utility System”) and provides retail electric power to Customer and other customers.

C. MRES is a joint action agency that supplies wholesale electric power supply to Local Utility pursuant to a long-term exclusive supply contract that requires Local Utility to purchase from MRES all electric power supply in excess of that provided by the Western Area Power Administration.

D. Pursuant to a waiver/agreement with the Federal Energy Regulatory Commission under the Public Utility Regulatory Policies Act (“PURPA”), MRES is required to purchase power from “qualifying facilities,” as defined by PURPA, and Local Utility is required to interconnect, supply power to, and allow qualifying facilities to operate in parallel with the Local Utility System. MRES and Local Utility are also permitted, but not required, to take such actions with respect to electric generating facilities which do not constitute “qualifying facilities” under PURPA.

E. Customer desires to interconnect and operate the Qualifying Facility in parallel with the Local Utility System and sell power generated by the Qualifying Facility to MRES, and Local Utility and MRES are willing to do so pursuant to the terms and conditions of this Agreement.

NOW, THEREFORE, the Parties hereby agree as follows:

1. Scope and Purpose. This Agreement sets forth the terms and conditions under which the Qualifying Facility may be interconnected to, and operated in parallel with, the Local

Utility System and under which MRES will purchase electrical energy generated by the Qualifying Facility. This Agreement does not constitute an agreement by MRES or Local Utility to deliver electrical energy generated by the Qualifying Facility or to provide any services to Customer except as described in this Agreement.

2. Interconnection Rules. The procedures and technical requirements governing the interconnection and operation of the Qualifying Facility are described in the documents of Local Utility entitled “MN Interconnection Process” (the “Procedures”) and “Technical Specifications Manual” (the “Requirements”), each as may be amended by Local Utility from time to time (collectively, the “Interconnection Rules”). Local Utility shall have the right to amend the Interconnection Rules from time to time in its sole discretion. The Interconnection Rules are incorporated and made part of this Agreement by this reference. Customer acknowledges it has received a copy of the Interconnection Rules and agrees to comply with the terms of the Interconnection Rules. In the event any terms of this Agreement conflict with the terms of the Interconnection Rules, the terms of this Agreement shall govern. All capitalized terms used in this Agreement shall have the meanings given them in the Interconnection Rules, unless otherwise expressly provided herein.

3. Point of Common Coupling. The point where the Interconnection Facilities connect with the Local Utility System is the Point of Common Coupling (“PCC”) as shown on the diagram in Exhibit A. The diagram included in Exhibit A shall depict the PCC, the location of meter(s), the point of delivery, and such other detail as may be required by Local Utility. Customer and Local Utility shall interconnect the Qualifying Facility to the Local Utility System at the PCC in accordance with the Interconnection Rules and all applicable laws, regulations and prudent utility practices. Local Utility and Customer shall each own and be responsible for the installation, maintenance and repair of the lines, wires, switches and other equipment on their respective sides of the PCC. Unless otherwise specified in Exhibit B, Customer, at its cost, shall furnish, install, own, maintain and repair all interconnection equipment required at the PCC, in accordance with the Interconnection Rules and applicable laws, regulations and prudent utility practices. Final electrical connections between the Local Utility System and the Qualifying Facility shall be made by Local Utility.

4. Installation, Operation and Maintenance of Qualifying Facility. Customer shall install, operate and maintain the Qualifying Facility in accordance with the terms of this section.

a. Responsibility; Standards. Customer shall install, operate, maintain, repair and inspect the Qualifying Facility and shall be fully responsible for the Qualifying Facility, unless otherwise provided herein. Customer’s installation, operation, maintenance and repair of the Qualifying Facility shall be in accordance with this Agreement, the Interconnection Rules, all applicable laws, regulations, ordinances and building codes, and, as applicable, the National Electrical Safety Code (“NESC”), American National Standards Institute (“ANSI”), Institute of Electrical and Electronic Engineers (“IEEE”), National Electrical Code (“NEC”), and Underwriter’s Laboratory (“UL”). In addition, Customer shall maintain the Qualifying Facility in accordance with applicable manufacturers’ recommended maintenance schedules.

b. Costs. Unless otherwise specified in Exhibit B, Customer shall be responsible for all costs associated with the Qualifying Facility, including all costs of installation, operation, maintenance, inspection and repair. Customer shall pay for the actual cost of the Interconnection Facilities and Distribution Upgrades along with Local Utility's cost to commission the proposed DER system. An estimate of the interconnection costs are set forth in Exhibit B.

c. Permits. Prior to installation of the Qualifying Facility, Customer shall obtain all environmental and other permits required by any governmental authorities to install, own and operate the Qualifying Facility. Customer shall maintain and comply with the requirements of all such permits during the term of this Agreement.

d. Disruption to Local Utility System. Customer shall design, install, equip, maintain, operate and repair the Qualifying Facility to ensure that the Local Utility System and Local Utility's service to other customers are not adversely affected by the Qualifying Facility, either due to disruptions to the Local Utility System or power quality issues.

e. Alterations. Customer shall not alter, modify or add to the Qualifying Facility without receiving a prior written determination of Local Utility, in accordance with the Interconnection Rules, as to whether the proposed alteration, modification or addition constitutes a Material Modification to the Interconnection Application. Not less than twenty (20) days prior to the commencement of any proposed alteration, modification or addition to the Qualifying Facility, Customer shall notify Local Utility of the proposal and provide Local Utility with all information reasonably required by Local Utility to review such proposal, including any change in generation capacity of the Qualifying Facility and any alterations to applicable interconnection equipment. Local Utility shall have ten (10) days to notify Customer in writing of Local Utility's final determination of the proposed modification.

f. Operator in Charge. Customer shall identify an individual (by name or title) who will act as "Operator in Charge" of the Qualifying Facility. This individual must be familiar with the terms of this Agreement, the Interconnection Rules, and any other laws, regulations or agreements that may apply to the Qualifying Facility.

5. Electric Service. Local Utility shall provide electric service to Customer for the electricity requirements of Customer not supplied by the Qualifying Facility. Such electric service shall be supplied by Local Utility under the rules and rate schedules of Local Utility applicable to Customer's class of service, as revised from time to time by Local Utility in its sole discretion.

6. Metering.

a. Metering Equipment. Local Utility shall purchase, own, install and maintain such metering equipment as is necessary to meter all electrical energy of the Qualifying Facility delivered to the Local Utility System, consistent with the metering arrangement elected pursuant to subsection (b) below. The metering equipment and cost responsibilities associated with such equipment are set forth in Exhibit B. Local Utility shall test the metering equipment on a scheduled basis. If the metering equipment fails to

register proper amounts or the registration thereof becomes so erratic as to be meaningless, the energy delivered to the Local Utility System shall be determined by Local Utility from the best information available.

b. Metering Arrangement. The metering arrangement used to meter and record electrical energy delivered from the Qualifying Facility to the Local Utility System, and from the Local Utility to Customer, shall be as set forth in attached Exhibit B.

7. Testing. Customer shall test the Qualifying Facility and interconnection equipment and provide to Local Utility all records of testing in accordance with the Interconnection Rules. Such testing shall occur prior to commencement of operation of the Qualifying Facility and periodically thereafter, in accordance with the Interconnection Rules or as otherwise requested by Local Utility. Local Utility and MRES shall have the right to witness all field testing and review all records prior to allowing the Qualifying Facility to commence normal operations. Such tests are for purposes of assuring the protection and operation of the Local Utility System and in no way represent any assurance of protection and operation of the Qualifying Facility.

8. Right of Access; Inspection. Local Utility and MRES shall have the right to inspect the Qualifying Facility and observe the Qualifying Facility's installation, commissioning, startup, operation and maintenance. Local Utility and MRES shall have access to the Qualifying Facility for any reasonable purpose in connection with the interconnection described in this Agreement or the Interconnection Rules or to provide service to other customers.

9. Disconnection. The Qualifying Facility shall or may be disconnected from the Local Utility System at such times as described in, and in accordance with, the terms of this section.

a. Disconnection by Customer. Customer shall disconnect the Qualifying Facility from the Local Utility System upon the effective date of the termination of this Agreement as described in Section 15 below.

b. Disconnection by Local Utility. Local Utility shall have the right to disconnect, or cause Customer to disconnect, the Qualifying Facility from the Local Utility System for the following reasons: (i) to allow Local Utility to operate, construct, install, maintain, repair, replace or inspect any facilities of Local Utility; (ii) the disruption or potential disruption of the Local Utility System as described in Section 4(d) above; (iii) the presence of a condition which could cause injury or loss of life or damage to the Local Utility System or property of a third party; (iv) if Local Utility is required to disconnect by MRES or Local Utility's transmission provider; (v) Customer's noncompliance with the terms of this Agreement; (vi) the termination of this Agreement as provided in Section 15 below; or (vii) any other reason for disconnection as set forth in the Interconnection Rules. Local Utility shall use reasonable efforts to provide prior notice and coordination of any disconnection of the Qualifying Facility due to routine maintenance, repairs or modifications to the Local Utility System. Neither Local Utility nor MRES shall be liable to Customer for any damages, losses or other liabilities, including consequential damages, due to the disconnection of the Qualifying Facility as described in this section.

10. Interconnected Operation. Customer may operate interconnected with the Local Utility System only in accordance with this Agreement and the Interconnection Rules. Local Utility, MRES and Customer shall comply with all requirements of the transmission provider and any regulatory authorities having jurisdiction over distributed generation interconnected to the Local Utility System.

11. Energy Sales to MRES. MRES shall purchase all electrical energy generated by the Qualifying Facility which is received by the Local Utility System. The rate paid by MRES for such electrical energy shall be equal to the sum of: (a) the MRES PURPA rate for qualifying facilities of 100 kW or less, as adjusted from time to time by MRES in its discretion, and (b) the Loss Factor Adjustment, as adjusted from time to time by MRES and Local Utility in their discretion. The MRES PURPA rate and the Loss Factor Adjustment, along with their currently applicable amounts, are described in attached Exhibit B. Customer shall receive payment for electrical energy sales to MRES through a credit on Customer's monthly invoice from Local Utility, which credit may be one month in arrears. MRES, in turn, shall credit the monthly wholesale power supply bill submitted by MRES to Local Utility in an amount equal to the electrical energy purchases of MRES from the Qualifying Facility during the preceding month. Local Utility shall provide to MRES, as soon as available following the end of each month, data indicating the amount of electrical energy purchased by MRES from the Qualifying Facility during the preceding month.

12. Limitation of Liability. Each Party's liability to the other Parties for any loss, cost, claim, injury, liability, or expense, including reasonable attorney's fees, relating to or arising from any act or omission in its performance of its obligations under this Agreement shall be limited to the amount of direct damage actually incurred. In no event shall a Party be liable to another party under this Agreement for any punitive, incidental, indirect, special or consequential damages, including for loss of business opportunity or profits. In addition, and notwithstanding any other provision in this Agreement, Local Utility's liability to Customer under this Agreement shall be further limited as set forth in Local Utility's tariffs and/or terms and conditions for electric service, which limitations are incorporated herein by this reference.

13. Insurance. Customer shall maintain general liability insurance in accordance with the terms of the Interconnection Rules.

14. Default; Remedies. A Party shall be in default under this Agreement if such Party fails to comply with, observe or perform, or defaults in the performance of, any covenant or obligation under this Agreement and fails to cure the failure within thirty (30) days after receiving written notice from another Party, which notice shall identify the basis of the default. If a default is not cured within the cure period, the non-defaulting Party or Parties shall have the right to terminate this Agreement by written notice to the defaulting Party, shall be relieved of any further obligation under this Agreement, and shall be entitled to pursue all other damages and remedies available under this Agreement or at law or in equity.

15. Term. This Agreement shall take effect upon execution by all Parties hereto and shall remain in effect unless terminated in accordance with this section. This Agreement may be terminated as follows: (a) any Party may terminate this Agreement at any time upon ninety (90) days' written notice to the other Parties; (b) Local Utility or MRES may terminate this Agreement

at any time upon thirty (30) days' written notice to the other Parties if the Qualifying Facility is not, or at any time ceases to be, a "qualifying facility" under PURPA; (c) any Party may terminate this Agreement after a default under Section 14 above; and (d) MRES may terminate this Agreement upon sixty (60) days' written notice to the other Parties in the event MRES determines that its purchase of electrical energy generated by the Qualifying Facility under Section 11 above would result in cost greater than those which MRES would incur if it did not make such purchases, as permitted by the PURPA waiver/agreement described in Recital D above. In the event this Agreement is terminated pursuant to subsection (d), Local Utility and Customer shall enter into a new agreement which defines their respective rights and obligations with respect to the interconnection and operation of the Qualifying Facility to and with the Local Utility System in accordance with PURPA.

16. Force Majeure. For purposes of this Agreement, a force majeure event is any event that is beyond the reasonable control of the affected Party and that the affected Party is unable to prevent by exercising reasonable diligence, including the following events or circumstances, but only to the extent they satisfy the preceding requirements: acts of war, terrorism, public disorder, rebellion or insurrection; floods, hurricanes, earthquakes, lightning, storms or other acts of God; explosions or fires; strikes, work stoppages or labor disputes; embargoes; and sabotage. If a force majeure event prevents a Party from fulfilling its duties under this Agreement, such Party shall promptly notify the other Party in writing and shall keep the other Party informed on a continuing basis of the scope and duration of the force majeure event. The affected Party shall specify the circumstances of the force majeure event, its expected duration, and the steps being taken to mitigate the effect of the event. The affected Party shall be entitled to suspend or modify its performance under this Agreement but will use reasonable efforts to resume its performance as soon as possible.

17. Non-Warranty. Neither by inspection, if any, nor by non-rejection or in any other way does Local Utility or MRES give or make any warranty, express or implied, as to the adequacy, safety or other characteristics of any lines, wires, switches, or other equipment or structures owned, installed or maintained by Customer.

18. Assignment. Customer may assign this Agreement to an entity or individual to whom Customer transfers ownership of the Qualifying Facility, so long as Customer obtains prior written consent of Local Utility and MRES, which consent shall not be unreasonably withheld, and such assignee agrees in writing to assume all obligations of Customer under this Agreement. Local Utility and/or MRES may assign this Agreement upon written notice to Customer.

19. No Waiver. The failure of a Party to insist, on any occasion, upon strict performance of any provision of this Agreement shall not be construed as a waiver or relinquishment of the obligations, rights or duties imposed upon the Parties.

20. Notices. Notices given under this Agreement shall be deemed to have been given when delivered in person or by mail, postage prepaid, to the respective addresses of the Parties set forth in the opening paragraph of this Agreement. Such addresses may be changed by written notification to the other Parties.

21. Severability. If any provision of this Agreement is adjudged by any court of competent jurisdiction to be illegal or unenforceable, such provision shall be deemed separate and independent, and the remainder of this Agreement shall remain in full force and effect.

22. Entire Agreement; Amendments. This Agreement, including the Interconnection Rules and all Exhibits hereto, constitutes the entire agreement and understanding between the Parties concerning the subject matter of this Agreement. The Parties are not bound by or liable for any statement, representation, promise, understanding or undertaking of any kind or nature, whether written or oral, with regard to the subject matter hereof not set forth or provided for herein. It is expressly acknowledged that the Parties may have other agreements covering other services not expressly provided for in this Agreement, which agreements are unaffected by this Agreement. This Agreement may be amended only upon mutual agreement of the Parties, which amendment will not be effective until reduced to writing and executed by the Parties.

23. Dispute Resolution. The city council or city-appointed body governing the Local Utility has authority to consider and determine disputes, if any, that arise under this Agreement. The Parties agree to use good faith efforts to resolve all disputes in accordance with the dispute resolution process adopted by the Local Utility's governing body pursuant to Minnesota Statutes §216B.164.

24. Governing Law; Jurisdiction. This Agreement and the rights and obligations of the Parties hereunder shall be construed in accordance with and shall be governed by the laws of the State of Minnesota.

[Signature Page Follows]

IN WITNESS WHEREOF, the Parties have caused this Interconnection and Power Purchase Agreement – 100 kW or Less (Standard Agreement) to be signed by their respective duly authorized representatives.

[LOCAL UTILITY NAME]

[CUSTOMER NAME]

BY: _____
TITLE: _____
DATE: _____

BY: _____
TITLE: _____
DATE: _____

MISSOURI BASIN MUNICIPAL POWER AGENCY
d/b/a MISSOURI RIVER ENERGY SERVICES

BY: _____
TITLE: _____
DATE: _____

EXHIBIT A
INTERCONNECTION APPLICATION

EXHIBIT B
METERING ARRANGEMENT AND PURCHASE RATE

1. MRES PURPA Rate. The rate to be paid by MRES for electrical energy purchased from the Qualifying Facility under Section 11 of the Agreement shall be equal to the MRES PURPA rate for 100 kW or less, as established by MRES in its sole discretion each year or upon other intervals as determined by MRES. The MRES PURPA rate for 100 kW or less for 20__ is \$_____/kWh. MRES shall notify Local Utility, and Local Utility shall notify Customer, of any change in such rate adopted by MRES. Customer's right to payments under Section 11 is subject to Customer's compliance with the terms, covenants and conditions of the Agreement.

2. Loss Factor Adjustment. The MRES PURPA rate for 100 kW or less, as described in Section 1 above, shall be increased by a percentage factor to reflect the savings resulting from reduced Local Utility System losses associated with electrical energy purchased from the Qualifying Facility under Section 11 of the Agreement. For example, if the Loss Factor Adjustment was 5%, the Loss Factor Adjustment to the 20__ MRES PURPA rate, in dollars, would be \$____ (\$_____ x 0.05), causing the total combined rate paid for power purchased from the Qualifying Facility to be \$_____/kWh. Local Utility and MRES shall establish the Loss Factor Adjustment each year or upon other intervals as they determine, and Local Utility shall notify Customer of any change in this factor. The Loss Factor Adjustment for 20__ is _____%.

3. Metering Arrangement.

a. Less than 40 kW QFs. A customer with a Qualifying Facility with a capacity of less than 40 kW can elect one of the following metering arrangements to measure the electrical energy generated by the Qualifying Facility which is received by the Local Utility System for purchase by MRES (Customer to select one):

_____. Net Metering. The metering shall be such that power delivered to Customer by Local Utility shall be netted against power received by Local Utility from the Qualifying Facility, pursuant to Minnesota Rules § 7835.3300. Local Utility's monthly invoice to Customer will indicate: (a) a credit to Customer if the power received by Local Utility from the Qualifying Facility exceeds the power provided by Local Utility to Customer or (b) the payment due by Customer to Local Utility if the power delivered by Local Utility to Customer exceeds the power received by Local Utility from the Qualifying Facility. The rate to be used to determine payment under subsection (a) for any net excess power received by the Local Utility System shall be the rate described in Section 11 of the Agreement.

_____. Dual Metering. The metering shall be such that all power received by the Local Utility from the Qualifying Facility (net of Customer's own use) shall be measured separately from power delivered from Local Utility to Customer, pursuant to Minnesota Rules § 7835.3400. The meter measuring power delivered to Customer shall not permit

reduction of measured power already delivered to Customer during periods when the Qualifying Facility generation exceeds Customer demand (i.e. no netting allowed). Local Utility shall credit Customer's monthly bill for power received by the Local Utility System and purchased by MRES. The rate paid by MRES for electrical energy generated by the Qualifying Facility which is received by the Local Utility System shall be the rate described in Section 11 of the Agreement.

b. 40 kW to 100 kW QFs. If the capacity of Customer's Qualifying Facility is 40 kW or more and less than or equal to 100 kW, then the metering arrangement to measure the electrical energy generated by the Qualifying Facility which is received by the Local Utility System for purchase by MRES shall be such that all power received by the Local Utility from the Qualifying Facility (net of Customer's own use) shall be measured separately from power delivered from Local Utility to Customer, pursuant to Minnesota Rules § 7835.3400. The meter measuring power delivered to Customer shall not permit reduction of measured power already delivered to Customer during periods when the Qualifying Facility generation exceeds Customer demand (i.e. no netting allowed). Local Utility shall credit Customer's monthly bill for power received by the Local Utility System and purchased by MRES. The rate paid by MRES for electrical energy generated by the Qualifying Facility which is received by the Local Utility System shall be the rate described in Section 11 of the Agreement.

c. Customer acknowledges and agrees that time-of-day purchase rates under Minnesota Rules § 7835.3500 are not available under this Agreement due to metering and technology limitations of Local Utility and Customer.

4. Environmental Attributes. Power purchased by MRES from the Qualifying Facility does not include any environmental attributes (i.e., renewable energy credits), if any, associated with the environmental character of the Qualifying Facility, nor any federal income tax credits for renewable energy that are accruable to Customer with respect to the Qualifying Facility.

5. Interconnection Costs. The Qualifying Facility is responsible for the actual, reasonable costs of interconnection which are estimated to be \$_____. The Qualifying Facility will pay Local Utility as follows:

_____.

6. Metering Equipment. Local Utility is responsible for furnishing the following metering equipment, if any: _____. Local Utility's cost responsibility, if any, associated with the metering equipment is as follows:

_____.

INTERCONNECTION PROCESS

Fast Track Process

SUMMARY

Interconnection Process for Distributed
Energy Resources less than 4 MW

Contents

- 1 Applicability**..... 1
 - 1.1. Capacity Limit..... 1
 - 1.2. Codes, Standards and Certification Requirements..... 1
- 2 Application Submission**..... 2
 - 2.1. Fast Track Process Application..... 2
 - 2.2. Professional Licensed Engineer Signature 2
 - 2.3. Processing Fee..... 2
 - 2.4. Battery Storage 3
 - 2.5. Site Control 3
- 3 Application Review** 3
 - 3.1. Timelines 3
 - 3.2. Initial Review Screens 4
 - 3.3. Notification of Approval of Application 6
 - 3.4. Failure of Review Screens 6
 - 3.5. Customer Options Meeting 6
- 4 Supplemental Review** 7
 - 4.1. Acceptance of Supplemental Review 7
 - 4.2. Supplemental Review Costs..... 7
 - 4.3. Supplemental Review Timelines 7
 - 4.4. Supplemental Review Screens..... 8
 - 4.5. Identification of Construction of Facilities..... 10
 - 4.6. Supplemental Review Results..... 10
- 5 MN Interconnection Agreement** 11
 - 5.1. MN Standard Agreement..... 11
 - 5.2. MN Interconnection Agreement..... 11
 - 5.3. Completion of Agreement 11
- 6 Insurance** 12
 - 6.1. Insurance Requirements..... 12
 - 6.2. Proof of Insurance..... 12

7	Timeline Extensions	13
7.1.	Reasonable Efforts	13
7.2.	Extensions	13
8	Modifications to Application	13
8.1.	Procedures	13
8.2.	Timelines	13
9	Interconnection	14
9.1.	Interconnection Milestones	14
9.2.	Metering	15
9.3.	Construction	15
9.4.	Inspection, Testing and Commissioning	15
9.5.	Interconnection Costs	16
9.6.	Security of Payment	17
9.7.	Non-Warranty	18
9.8.	Authorization for Parallel Operation	18
9.9.	Continual Compliance	19
9.10.	Disconnection of DER	19

1 Applicability

1.1. Capacity Limit

The Fast Track Process is available to an Interconnection Customer proposing to interconnect a Distributed Energy Resource (DER) with the Area EPS Operator’s Distribution System if the DER capacity does not exceed the size limits in Table 1.1 and does not qualify for the Simplified Process. The capacity is determined by the aggregated summation of the Nameplate Rating of all components that make up the DER system. Additional information regarding the capacity limits can be seen in Section 6 of the Process Overview document.

Table 1.1. Fast Track Eligibility for DER

Line Voltage	Fast Track Eligibility ¹ Regardless of Location	Fast Track Eligibility for certified, inverter-based DER on a Mainline ² and ≤ 2.5 Electrical Circuit Miles from Substation ³
< 5 kV	≤ 500 kW	≤ 500 kW
≥ 5 kV and < 15 kV	≤ 1 MW	≤ 2 MW
≥ 15 kV and < 30 kV	≤ 3 MW	≤ 4 MW
≥ 30 kV and ≤ 69 kV	≤ 4 MW	≤ 5 MW

Fast Track eligibility for DERs is determined based upon the generator type, the size of the generator, voltage of the line, and the location of and the type of line at the Point of Common Coupling. All synchronous and induction machines must be no larger than 2 MW to be eligible for Fast Track Process consideration. Fast Track eligibility does not imply or indicate that a DER will pass the engineering screens or be exempt from the proposed DER Interconnection being placed into the Study Process.

1.2. Codes, Standards and Certification Requirements

The Interconnection Customer’s proposed DER must meet the codes, standards and certification requirements listed in Section 14 of the Overview Process document and the Minnesota Technical Requirements. The Area EPS Operator may allow DER systems that do not meet codes, standards and certification only if the DER system design is reviewed and tested and determined that it is safe to operate in parallel with the Distribution System.

¹ Synchronous and induction machine eligibility is limited to no more than 2 MW even when line voltage is greater than 15 kV.

² For purposes of this table, a Mainline is the three-phase backbone of a circuit. It will typically constitute lines with wire sizes of 4/0 American wire gauge, 266 kcmil, 336.4 kcmil, 397.5 kcmil, 477 kcmil and 795 kcmil.

³ An Interconnection Customer can determine this information about its proposed interconnection location in advance by requesting a pre-application report described in the Overview Process document.

2 Application Submission

2.1. Fast Track Process Application

The Interconnection Customer shall complete the Interconnection Application and submit it to the Area EPS Operator to initialize the Interconnection Process. A completed Interconnection Application will include the following:

- A completed Interconnection Application signed by the Interconnection Customer.
- A non-refundable processing fee indicated in Section 2.3.
- A site layout drawing of the proposed DER system.
- A one-line diagram of the proposed DER system showing the point of common coupling to the Area EPS Operator’s Distribution System.
- All equipment manufacturer specification sheets.
- Documentation of site control indicated in Section 2.5.

2.2. Professional Licensed Engineer Signature

The one-line diagram submitted with the Interconnection Application will require a signature from a professional engineer licensed in the State of Minnesota certifying the DER was designed in conformance to the Minnesota Technical Requirements for the following conditions:

- Certified⁴ equipment is greater than 250 kW.
- Non-certified equipment is greater than 20 kW.

2.3. Processing Fee

The processing fee will differ for a Fast Track Interconnection Application depending on the type of equipment utilized, as set forth in Table 2.1.

Table 2.1. Interconnection Application Process Fee

Equipment Type	Process Fee
Certified System	\$100 + \$1/kW
Non-Certified System	\$100 + \$2/kW

⁴ Additional information regarding certified equipment is found in Section 14 of the Process Overview document and the Minnesota Technical Requirements.

2.4. Battery Storage

An inverter-based DER system may include battery storage. DER systems that include battery storage should complete the MN Energy Storage Application along with the Interconnection Application.

2.5. Site Control

Documentation of site control must be submitted with the Interconnection Application. Site control may be demonstrated by any of the following:

- Ownership of, a leasehold interest in, or a right to develop a site for the purpose of constructing the DER system.
- An option to purchase or acquire a leasehold site for constructing the DER system.
- An exclusivity or other business relationship between the Interconnection Customer and the entity having the right to sell, lease, or grant the Interconnection Customer the right to possess or occupy a site for constructing the DER system.

3 Application Review

3.1. Timelines

The Interconnection Application shall be date- and time-stamped upon initial, and if necessary, resubmission receipt. The Interconnection Customer shall be notified of receipt by the Area EPS Operator within ten (10) Business Days of receipt of the Interconnection Application.

The Area EPS Operator shall notify the Interconnection Customer if the Interconnection Application is deemed incomplete within ten (10) Business Days and provide a written list detailing all information that must be provided to complete the Interconnection Application. The Interconnection Customer has ten (10) Business Days to provide the missing information unless the Interconnection Customer submits a valid request for a timeline extension. Failure to submit the requested information within the stated timeline will result in the Interconnection Application being deemed withdrawn. The Area EPS Operator has an additional five (5) Business Days to review the additionally provided information for completeness.

An Interconnection Application will be deemed complete upon submission to the Area EPS Operator provided all documents, fees and information required with the Interconnection Application adhering to the Minnesota Technical Requirements is included. The time- and date- stamp of the completed Interconnection Application shall

be accepted as the qualifying date for the purpose of establishing a queue position as described in Section 4.7 in the Process Overview document.

The Area EPS Operator has a total of twenty-five (25) Business Days to complete the Interconnection Application review and submit notice back to the Interconnection Customer stating the proposed DER system may proceed with the interconnection process or a supplemental review offer is to be made or the proposed DER system has been moved into a different process track. The period of time waiting for the Interconnection Customer to provide missing information is not included in the Area EPS Operator's twenty-five (25) Business Days review timeline.

3.2. Initial Review Screens

The Area EPS Operator shall determine if the DER can be interconnected safely and reliably without the construction of facilities by the Area EPS Operator by using a set of Initial Review Screens. The Initial Review screens include the following engineering screens:

- The proposed DER's Point of Common Coupling must be on a portion of the Area EPS Operator's Distribution System.
- For interconnection of a proposed DER to a radial distribution circuit, the aggregated generation, including the proposed DER, on the circuit shall not exceed 15% of the line section annual peak load as most recently measured or 100% of the substation aggregated minimum load. A line section is that portion of an Area EPS Operator's electric system connected to a customer bounded by automatic sectionalizing devices or the end of the distribution line. The Area EPS Operator may consider 100% of applicable loading (i.e. daytime minimum load for solar), if available, instead of 15% of line section peak load.
- For interconnection of a proposed DER to the load side of network protectors, the proposed DER must utilize an inverter-based equipment package and, together with the aggregated other inverter-based DERs, shall not exceed the smaller of 5% of a network's maximum load or 50 kW.⁵
- The proposed DER, in aggregation with other DERs on the distribution circuit, shall not contribute more than 10% to the distribution circuit's maximum fault current

⁵ Network protectors are protective devices used on secondary networks (spot and grid networks) to automatically disconnect associated transformers when reverse power flow occurs. Secondary networks are most often used in densely populated downtown areas.

at the point on the high voltage (primary) level nearest the proposed Point of Common Coupling.

- The proposed DER, in aggregate with other Distributed Energy Resources on the distribution circuit, shall not cause any distribution protective devices and equipment (including, but not limited to, substation breakers, fuse cutouts, and line reclosers), or Interconnection Customer equipment on the system to exceed 87.5% of the short circuit interrupting capability; nor shall the interconnection be proposed for a circuit that already exceeds 87.5% of the short circuit interrupting capability.
- Using the table below, determine the type of interconnection to a primary distribution line. This screen includes a review of the type of electrical service provided to the Interconnecting Customer, including line configuration and the transformer connection to limit the potential for creating over-voltages on the Area EPS Operator’s electric power system due to a loss of ground during the operating time of any anti-islanding function.

Table 3.1. Type of Primary Distribution Line Interconnections

Primary Distribution Line Type	Type of Interconnection to Primary Distribution Line	Results
Three-Phase, three wire	Three-phase or single-phase, phase-to-phase	Pass Screen
Three-phase, four wire	Effectively-grounded three-phase or single-phase, line-to-neutral	Pass Screen

- If the proposed DER is to be interconnected on single-phase shared secondary, the aggregate generation capacity on the shared secondary, including the proposed DER, shall not exceed 20 kW or 65% of the transformer nameplate rating.
- If the proposed DER is single-phase and is to be interconnected on a center tap neutral of a 240-volt service, its addition shall not create an imbalance between the two sides of the 240-volt service of more than 20% of the nameplate rating of the service transformer.

The technical screens listed shall not preclude the Area EPS Operator from using tools that perform screening functions using different methodologies provided the analysis is targeted to maintain the voltage, thermal and protection objectives as the listed screen.

3.3. Notification of Approval of Application

Provided the Interconnection Application passes the initial screens, or if the proposed interconnection fails the screens but the Area EPS Operator determines that the DER may nevertheless be interconnected consistent with safety, reliability and power quality standards, the Area EPS Operator shall provide notice to the Interconnection Customer that their Interconnection Application has been approved. The Area EPS Operator shall provide the Interconnection Customer with a MN Interconnection Agreement as outlined in Section 5.

3.4. Failure of Review Screens

If the proposed interconnection fails the screens, and the Area EPS Operator does not or cannot determine from the Initial Review that the DER may nevertheless be interconnected consistent with safety, reliability, and power quality standards, unless the Interconnection Customer is willing to consider minor modifications or further study, the Area EPS Operator shall provide the Interconnection Customer the opportunity to attend a customer options meeting.

The Area EPS Operator shall notify the Interconnection Customer of the determination and provide copies of all directly pertinent data and analyses underlying its conclusion, subject to confidentiality provisions in Section 12.1 of the Process Overview document.

3.5. Customer Options Meeting

Within ten (10) Business Days of the Area EPS Operator's notification to the Interconnection Customer of the proposed interconnection's failure of the engineering screens, the Area EPS Operator and the Interconnection Customer shall schedule a customer options meeting to review possible facility modification, screen analysis and related results to determine what further steps are needed to permit the DER to be interconnected safely and reliably to the Distribution System. At the customer options meeting the Area EPS Operator shall:

- Offer to perform a supplemental review in accordance with Section 4 and provide a non-binding good faith estimate of the cost of such review; or
- Obtain the Interconnection Customer's agreement to continue evaluating the Interconnection Application under the Study Process track.

4 Supplemental Review

4.1. Acceptance of Supplemental Review

To accept the offer of a supplemental review, the Interconnection Customer shall agree in writing and submit a deposit for the estimated costs of the supplemental review in the amount of the Area EPS Operator's good faith estimate of the costs of such review within fifteen (15) Business Days once the supplemental review offer is made by the Area EPS Operator. If the written agreement and deposit have not been received by the Area EPS Operator within that timeframe, the Interconnection Application can only continue being evaluated under the Study Process or it can be withdrawn by the Interconnection Customer.

The Interconnection Customer may specify within the written agreement the order in which the Area EPS Operator will complete the supplemental review screens listed in Section 4.4.

4.2. Supplemental Review Costs

The Interconnection Customer shall be responsible for the Area EPS Operator's actual costs for conducting the supplemental review. The Interconnection Customer shall pay any review costs that exceed the deposit within twenty (20) Business Days of receipt of the invoice or resolution of any dispute. If the deposit exceeds the invoiced costs, the Area EPS Operator will return such excess within twenty (20) Business Days of the invoice without interest.

4.3. Supplemental Review Timelines

Within thirty (30) Business Days following the receipt of the deposit for a supplemental review, the Area EPS Operator shall:

- Perform the supplemental review using the screens in Section 4.4.
- Notify the Interconnection Customer of the results in writing.
- Include copies of the Area EPS Operator's analysis under the screens with the written notification.

Unless the Interconnection Customer provides instruction for how to respond to a failure of any of the supplemental review screens in the written acceptance of supplemental review, the Area EPS Operator shall notify the Interconnection Customer within two (2) Business Days if a supplemental review screen is failed or if the Area EPS

Operator is unable to perform the supplemental review screen. The Area EPS Operator shall then obtain the Interconnection Customer's permission to either:

- Continue evaluating the proposed interconnection using the supplemental review screens in Section 4.4.
- Terminate the supplemental review and continue evaluating the Interconnection Application in the Study Process track.
- Terminate the supplemental review upon withdrawal of the Interconnection Application by the Interconnection Customer.

The Interconnection Customer shall respond with its choice within five (5) Business Days of notification from the Area EPS Operator.

4.4. Supplemental Review Screens

The three supplemental review screens are the Minimum Load screen, the Voltage and Power Quality screen and the Safety and Reliability screen.

4.4.1. Minimum Load Screen

The aggregate DER capacity on the line section is less than 100% of the minimum load for all line sections bounded by automatic sectionalizing devices upstream of the proposed DER. If minimum load data is not available, or cannot be calculated, estimated or determined, the Area EPS Operator shall include the reason(s) that it is unable to calculate, estimate or determine minimum load in its supplemental review results notification under Section 4.3. The line section minimum load data shall include onsite load but not station service load served by the proposed DER in this screen.

The type of generation used by the proposed DER will be considered when calculating, estimating, or determining circuit or line section minimum load relevant for the application of this screen. Solar photovoltaic (PV) generation systems with no battery storage use daytime minimum load (i.e. 10 a.m. to 4 p.m. for fixed panel systems and 8 a.m. to 6 p.m. for PV systems utilizing tracking systems), while all other generation uses absolute minimum load.

When this screen is being applied to a DER that serves some station service load, only the net injection into the Area EPS Operator's electric system will be considered as part of the aggregate generation.

The Area EPS Operator will not consider as part of the aggregate generation for purposes of this screen DER capacity known to be already reflected in the minimum load data.

4.4.2. Voltage and Power Quality Screen

In aggregate with existing generation on the line section, the following conditions shall be met for the screen to be passed:

- The voltage regulation on the line section can be maintained in compliance with relevant requirements under all system conditions.
- The voltage fluctuation is within acceptable limits as defined by Institute of Electrical and Electronics Engineers (IEEE) Standard 1453, or utility practice similar to IEEE Standard 1453.
- The harmonic levels meet IEEE Standard 519 limits.

4.4.3. Safety and Reliability Screen

The location of the proposed DER and the aggregate generation capacity on the line section do not create impacts to safety or reliability that cannot be adequately addressed without application of the Study Process. The Area EPS Operator shall give due consideration to the following and other factors in determining potential impacts to safety and reliability in applying this screen.

- Whether the line section has significant minimum loading levels dominated by a small number of customers (e.g., several large commercial customers).
- Whether the loading along the line section is uniform or even.
- Whether the proposed DER is located in close proximity to the substation (i.e., less than 2.5 electrical circuit miles), and whether the line section from the substation to the Point of Common Coupling is a main line rated for normal and emergency ampacity.
- Whether the proposed DER incorporates a time delay function to prevent reconnection of the generator to the system until system voltage and frequency are within normal limits for a prescribed time.

- Whether operational flexibility is reduced by the proposed DER, such that transfer of the line section(s) of the DER to a neighboring distribution circuit/substation may trigger overloads or voltage issues.
- Whether the proposed DER employs equipment or systems certified by a recognized standards organization to address technical issues such as, but not limited to, islanding, reverse power flow, or voltage quality.

4.5. Identification of Construction of Facilities

If the proposed interconnection requires the construction of any distribution or transmission facilities, the Area EPS Operator shall notify the Interconnection Customer of the requirement when it provides the supplemental review results. The Area EPS Operator may include a non-binding good faith estimate to construct the facilities included with the supplemental review results. In lieu of providing a non-binding good faith estimate to construct the necessary facilities, the Area EPS Operator may require the proposed interconnection to move to the Study Process for a facility study instead.

Upon being presented with either the non-binding good faith estimate or the requirement for a facility study, the Interconnection Customer has five (5) Business Days to inform the Area EPS Operator to proceed with the proposed interconnection or withdraw the Interconnection Application.

4.6. Supplemental Review Results

If the proposed interconnection passes the supplemental review screens in Section 4.4 and does not require construction of distribution or transmission facilities by the Area EPS on its own system, the Area EPS Operator shall provide an executable MN Interconnection Agreement within five (5) Business Days after the supplemental review screens are completed. Information regarding the MN Interconnection Agreement is detailed in Section 5.

If the proposed interconnection passes the supplemental review screens in Section 4.4 and the Interconnection Customer agrees to the non-binding good faith estimate of construction of any distribution or transmission facilities by the Area EPS Operator, the Area EPS Operator shall provide an executable MN Interconnection Agreement within twenty (20) Business Days. Included with the MN Interconnection Agreement shall be non-binding good faith estimate of construction costs and a construction schedule for the facilities. Information regarding the MN Interconnection Agreement is detailed in Section 5.

If the proposed interconnection does not pass the supplemental review screens in Section 4.4 the Area EPS Operator shall provide the Interconnection Customer with the option of commencing the Study Process. The Interconnection Customer shall notify the Area EPS Operator within fifteen (15) Business Days if they wish to proceed with the Study Process to retain their queue position or the Interconnection Application will be deemed withdrawn.

5 MN Interconnection Agreement

5.1. MN Standard Agreement

For a proposed interconnection that meets the conditions of being classified as a qualifying facility less than 40 kW, the Area EPS Operator shall provide the Interconnection Customer with an executable copy of the MN Standard Agreement.

5.2. MN Interconnection Agreement

For proposed interconnections that do not meet the conditions of being classified as a qualifying facility 100 kW or less, or if requested by the Interconnection Customer in lieu of signing the MN Standard Agreement, the Area EPS Operator shall provide an executable copy of the MN Interconnection Agreement.

5.3. Completion of Agreement

The Interconnection Customer must return a signed MN Standard Agreement or MN Interconnection Agreement at least thirty (30) Business Days prior to the requested in-service date of the proposed DER. The Area EPS Operator shall sign and return a copy of the fully executed MN Standard Agreement or the MN Interconnection Agreement back to the Interconnection Customer.

The Interconnection Customer may update the requested in-service date submitted on the Interconnection Application to a date thirty (30) Business Days or later from the date on which the Interconnection Customer submits a signed MN Standard Agreement or MN Interconnection Agreement and payment if required unless the Area EPS Operator agrees to an earlier date.

Upon receipt of the signed MN Standard Agreement or MN Interconnection Agreement, the Area EPS Operator may schedule appropriate metering replacements and construction of facilities, if necessary.

6 Insurance

6.1. Insurance Requirements

At minimum, the Interconnection Customer shall maintain, for the duration the DER system is interconnected to the Area EPS Operator’s Distribution System, general liability insurance from a qualified insurance agency with a B+ or better rating by “Best” with a combined single limit of not less than described in Table 6.1. Such general liability insurance shall include coverage against claims for damages resulting from (i) bodily injury, including wrongful death; and (ii) property damage arising out of the Interconnection Customer’s ownership and/or operation of the DER under this agreement. Evidence of the insurance shall state that coverage provided is primary and is not excess to or contributing with any insurance or self-insurance by the Area EPS Operator.

Table 6.1. Liability Insurance Requirements

DER System Size	Liability Insurance Requirement
< 40 kW AC	\$300,000
≥ 40 kW AC and < 250 kW AC	\$1,000,000
≥ 250 kW AC and < 5 MW AC	\$2,000,000
≥ 5 MW AC	\$3,000,000

For all proposed DER systems, except those that are qualifying systems less than 40 kW AC, the general liability insurance shall, by endorsement to the policy or policies:

- Include the Area EPS Operator as additionally insured.
- Contain a severability of interest clause or cross-liability clause.
- Provide that the Area EPS Operator shall not by reason incur liability to the insurance carrier for the payment of premiums for such insurance if the Area EPS Operator is included as an additionally insured.

6.2. Proof of Insurance

The Interconnection Customer shall furnish the required insurance certificates and endorsements to the Area EPS Operator prior to the initial operation of the DER. A copy of the Declaration page of the Homeowner’s insurance policy is a common example of an insurance certificate. Thereafter, the Area EPS Operator shall have the right to periodically inspect or obtain a copy of the original policy or policies of insurance. Additionally, the Area EPS Operator may request to be additionally listed as an interested third party on the insurance certificates and endorsements for qualifying

facilities less than 40 kW AC to meet the right to periodically obtain a copy of the policy or policies of insurance.

7 Timeline Extensions

7.1. Reasonable Efforts

The Area EPS Operator shall make Reasonable Efforts to meet all time frames provided in these procedures. If the Area EPS Operator cannot meet a deadline provided herein, it must notify the Interconnection Customer in writing within three (3) Business Days after the deadline to explain the reason for the failure to meet the deadline and provide an estimated time by which it will complete the applicable interconnection procedure in the process.

7.2. Extensions

For applicable time frames described in these procedures, the Interconnection Customer may request, in writing, one extension equivalent to half of the time originally allotted (e.g., ten (10) Business Days for a twenty (20) Business Days original time frame) which the Area EPS Operator may not unreasonably refuse. No further extensions for the applicable time frame shall be granted absent a Force Majeure Event or other similarly extraordinary circumstance.

8 Modifications to Application

8.1. Procedures

At any time after the Interconnection Application is deemed complete, the Interconnection Customer or the Area EPS Operator may identify modifications to the proposed DER system that may improve costs and benefits (including reliability) of the proposed DER system and the ability for the Area EPS Operator to accommodate the proposed DER system. The Interconnection Customer shall submit to the Area EPS Operator in writing all proposed modifications to any information provided in the Interconnection Application. The Area EPS Operator cannot unilaterally modify the Interconnection Application.

8.2. Timelines

Within ten (10) Business Days of receipt of the proposed modification, the Area EPS Operator shall evaluate whether the proposed modification to the Interconnection Application constitutes a Material Modification. The definition of Material Modification in the Section 13 Glossary of the Process Overview document includes examples of what does and does not constitute a Material Modification.

The Area EPS Operator shall notify the Interconnection Customer in writing of the final determination of the proposed modification. For proposed modifications that are determined to be a Material Modification, the Interconnection Customer may choose to either: 1) withdraw the proposed modification; or 2) proceed with a new Interconnection Application. The Interconnection Customer shall provide its determination in writing to the Area EPS Operator within ten (10) Business Days after being provided the Material Modification determination. If the Interconnection Customer does not provide its determination within the timeline, the Interconnection Application shall be considered withdrawn.

If the proposed modification is not determined to be a Material Modification, then the Area EPS Operator shall notify the Interconnection Customer in writing that the modification has been accepted and the Interconnection Customer shall retain its eligibility for interconnection, including its place in the queue.

9 Interconnection

9.1. Interconnection Milestones

For DER systems that are not a qualifying facility less than 40 kW AC, the Interconnection Customer and the Area EPS Operator shall agree on milestones for which each Party is responsible and list them in Attachment IV of the MN Interconnection Agreement. To the greatest extent possible, the Parties will identify all design, procurement, installation and construction requirements associated with the project, and clear associated timelines, at the beginning of the design, procurement, installation and construction phase, or as early within the process as possible.

A Party's obligation under this provision may be extended by agreement. If a Party anticipates that it will be unable to meet a milestone for any reason other than a Force Majeure Event, it shall immediately notify the other Party of the reason(s) for not meeting the milestone, propose the earliest reasonable alternative date in which this and future milestones will be met, and request appropriate amendments to the MN Interconnection Agreement and its attachments. The Party affected by the failure to meet a milestone shall not unreasonably withhold agreement to such an amendment unless:

- The Party will suffer significant uncompensated economic or operational harm from the delay, or
- Attainment of the same milestone has previously been delayed, or

- The Party has reason to believe the delay in meeting the milestone is intentional or unwarranted notwithstanding the circumstance explained by the Party proposing the amendment.

If the Party affected by the failure to meet a milestone disputes the proposed extension, the affected Party may pursue dispute resolution as described in the Process Overview document.

9.2. Metering

Any metering requirements necessitated by the use of the DER system shall be installed at the Interconnection Customer's expense. The metering requirement costs will be included in a final invoice of interconnection costs to the Interconnection Customer. The Interconnection Customer is also responsible for metering replacement costs not covered in the Interconnection Customer's general customer charge. The Area EPS Operator may charge Interconnection Customers an ongoing metering-related charge for an estimate of ongoing metering-related costs specifically demonstrated.

9.3. Construction

The Interconnection Customer may proceed to construct (including operational testing not to exceed two hours) the DER system when the Area EPS Operator has approved the Interconnection Application. Upon receipt of a signed MN Standard Agreement or MN Interconnection Agreement the Area EPS Operator shall schedule and execute appropriate construction of facilities.

9.4. Inspection, Testing and Commissioning

Upon completing construction of the DER system, the Interconnection Customer will cause the DER system to be inspected or otherwise certified by the appropriate local electrical wiring inspector with jurisdiction. The Interconnection Customer shall then arrange for the inspection and testing of the DER system and the Customer's Interconnection Facilities prior to interconnection pursuant to the applicable Minnesota Technical Requirements. Commissioning tests of the Interconnection Customer's installed equipment shall be performed pursuant to applicable codes and standards of the applicable Minnesota Technical Requirements.

The Interconnection Customer shall notify the Area EPS Operator of testing and inspection no fewer than five (5) Business Days in advance, or as may be agreed to by the Parties. The Interconnection Customer shall provide to the Area EPS Operator a testing procedure that will be followed on the day of testing and inspection no fewer than ten (10) Business Days prior to the testing and inspection date. The testing procedure should include tests and/or inspections to confirm the DER system will meet

the technical requirements of interconnection. The Area EPS Operator shall review the testing procedure for completeness and shall notify the Interconnection Customer if the testing procedure fails to address components of the technical requirements for interconnection.

The Area EPS Operator shall send qualified personnel to the DER site to inspect the interconnection and witness the testing, but the Area EPS Operator bears no liability for the results of the test. Testing and inspection shall occur on a Business Day at a mutually agreed upon date and time. The Area EPS Operator may waive the right to witness the testing.

9.5. Interconnection Costs

9.5.1 Estimation of Interconnection Costs

The Interconnection Customer shall pay for the actual cost of the Interconnection Facilities and Distribution Upgrades along with the Area EPS Operator's cost to commission the proposed DER system. An estimate of the interconnection costs shall be stated in the MN Standard Agreement or in the MN Interconnection Agreement as a detailed itemization of such costs. If Network Upgrades are required, the actual cost of the Network Upgrades, including overheads, shall be borne by the Interconnection Customer pursuant to the Transmission Provider and associated agreements.

9.5.2 Progressive Payment of Interconnection Costs

The Area EPS Operator shall bill the Interconnection Customer for the design, engineering, construction and procurement costs of the Interconnection Facilities and Upgrades described in the MN Interconnection Agreement or MN Standard Agreement on a monthly basis or other basis agreed upon by both Parties in the MN Interconnection Agreement or as listed in the MN Standard Agreement. The Interconnection Customer shall pay each bill within twenty-one (21) Business Days or as agreed to in the MN Interconnection Agreement or MN Standard Agreement.

9.5.3 Final Accounting of Interconnection Facilities and Upgrade Costs

If distribution or transmission facilities required upgrades to accommodate the proposed DER system, the Area EPS Operator shall render the final interconnection cost invoice to the Interconnection Customer within eighty (80) Business Days (approximately four calendar months) of completing the construction and installation of the Area EPS Operator's Interconnection Facility and Upgrades. The Area EPS Operator shall provide the Interconnection Customer with a final accounting report identifying the

difference between the actual Interconnection Customer's cost responsibility and the Interconnection Customer's previous aggregate payments to the Area EPS Operator for the specific DER system interconnection. Upon the final accounting submitted to the Interconnection Customer, the balance between the actual cost and previously aggregated payments shall be paid to the Area EPS Operator within twenty (20) Business Days. If the balance between the actual cost and previously aggregated payments is a credit, the Area EPS Operator shall refund the Interconnection Customer within twenty (20) Business Days.

- 9.5.4 Final Interconnection Costs without Facilities and Upgrades Needed
Within thirty (30) Business Days the final invoice for the interconnection costs shall be rendered to the Interconnection Customer once the proposed DER system has been commissioned by the Area EPS Operator, or upon the commissioning being waived by the Area EPS Operator. The Interconnection Customer shall make payment to the Area EPS Operator within twenty-one (21) Business Days of receipt, or as otherwise stated in the MN Standard Agreement or MN Interconnection Agreement.

9.6. Security of Payment

At the option of the Area EPS Operator, either the "Traditional Security" or the "Modified Security" method shall be used for assurance of payment of interconnection cost.

Under the Traditional Security method, the Interconnection Customer shall provide reasonable, adequate assurances of credit, including a letter of credit or personal guaranty of payment and performance from a creditworthy entity acceptable under the Area EPS Operator credit policy. The letter of credit shall also include procedures for the unpaid balance of the estimated amount shown in the MN Interconnection Agreement for the totality of all anticipated work or expense incurred by the Area EPS Operator associated with the Interconnection Application. The payment for these estimated costs shall be as follows:

- 1/3 of estimated costs shall be due no later than when the Interconnection Customer signs the MN Interconnection Agreement.
- An additional 1/3 of estimated costs shall be due prior to initial energization of the DER with the Area EPS Operator.

- Remainder of actual costs, incurred by Area EPS Operator, shall be due within thirty (30) Business Days from the date the bill is mailed by the Area EPS Operator after project completion.

Under the Modified Security method, at least twenty (20) Business Days prior to the commencement of the design, procurement, installation, or construction of a discrete portion of the Area EPS Operator's Interconnection Facilities and Upgrades, the Interconnection Customer shall provide the Area EPS Operator, at the Interconnection Customer's option, a guarantee, letter of credit or other form of security that is reasonably acceptable to the Area EPS Operator and is consistent with the Minnesota Uniform Commercial Code. Such security for payment shall be in an amount sufficient to cover the costs for constructing, designing, procuring, and installing the applicable portion of the Area EPS Operator's Interconnection Facilities and Upgrades and shall be reduced on a dollar-for-dollar basis for payments made to the Area EPS Operator under the MN Interconnection Agreement during its term.

The guarantee must be made by an entity that meets the creditworthiness requirements of the Area EPS Operator and contain terms and conditions that guarantee payment of any amount that may be due from the Interconnection Customer, up to an agreed-to maximum amount.

The letter of credit must be issued by a financial institution or insurer reasonably acceptable to the Area EPS Operator and must specify a reasonable expiration date not sooner than sixty (60) Business Days (three calendar months) after the due date of the final accounting report and bill described in Section 9.5

9.7. Non-Warranty

Area EPS Operator does not give any warranty, expressed or implied, as to the adequacy, safety, or other characteristics of any structures, equipment, wires, appliances or devices owned, operated, installed or maintained by the Interconnection Customer, including without limitation the DER and any structures, equipment, wires, appliances or devices not owned, operated or maintained by the Area EPS Operator. The Area EPS Operator does not guarantee uninterrupted power supply to the DER and will operate the Distribution System with the same reliability standards for the entire customer base.

9.8. Authorization for Parallel Operation

The Interconnection Customer shall not operate its DER system in parallel with the Area EPS Operator's Distribution System without prior written authorization from the Area EPS Operator. The Area EPS Operator shall provide such authorization within

three (3) Business Days from when the Area EPS Operator receives notification that the Interconnection Customer has complied with all applicable parallel operations requirements and commissioning has been successfully completed. Such authorization shall not be unreasonably withheld, conditioned or delayed.

9.9. Continual Compliance

The Interconnection Customer shall be fully responsible to operate, maintain, and repair the DER as required to ensure that it complies at all times with the interconnection standards to which it has been certified. The Interconnection Customer shall also operate its DER system in compliance with the Area EPS Operator's Technical Requirements referred to in the executed MN Standard Agreement or MN Interconnection Agreement. The Area EPS Operator may periodically inspect, at its own expense, the operation of the DER system as it relates to power quality, thermal limits and reliability. Failure by the Interconnection Customer to remain in compliance with the applicable Minnesota Technical Requirements will result in the disconnection of the DER system from the Area EPS Operator's Distribution System.

9.10. Disconnection of DER

The Area EPS Operator has the right to disconnect the DER in the event of the following:

- The Interconnection Customer does not continue to follow and maintain IEEE 1547 settings or functions as required by the Minnesota Technical Requirements.
- The DER does not meet all the requirements of the Fast Track Process.
- The Interconnection Customer refuses to sign either the MN Interconnection Agreement or the Area EPS Operator's MN Standard Agreement.

The Area EPS Operator may temporarily disconnect the DER upon the following conditions:

- For scheduled outages upon reasonable notice.
- For unscheduled outages or emergency conditions.
- If the DER does not operate in a manner consistent with the Fast Track Process.

The Area EPS Operator shall inform the Interconnection Customer in advance of any scheduled disconnections, or as reasonable, after an unscheduled disconnection.

Interconnection Application

Persons interested in applying for the interconnection of a distributed energy resource to the Local Utility’s distribution system through the Fast Track or Study Processes are to fill out this Interconnection Application. The Interconnection Application is to be filled out completely by the applicant or as noted in each section of the application. The Local Utility will contact the applicant within 10 business days once the Interconnection Application and the corresponding processing fee is submitted to the Local Utility. The Local Utility will then notify the applicant of the completeness of their application. If the application is deemed incomplete by the Local Utility, the Local Utility will provide the applicant with a list of missing material. The applicant will then have 10 business days to provide the Local Utility with this information or request an extension, otherwise the application will be deemed incomplete and the applicant will lose their place in the queue. Sections that are noted with * are required to be filled out.

Checklist for Submission to Local Utility	
<i>The items below shall be included with submittal of the Interconnection Application to the Local Utility. Failure to include all items will deem the Interconnection Application incomplete.</i>	
	Included
Non-Refundable Processing Fee Fast Track <ul style="list-style-type: none"> • \$100 + \$1/kW for Certified Systems • \$100 + \$2/kW for Non-Certified Systems Study Process <ul style="list-style-type: none"> • \$1,000 + \$2/kW down payment. Additional study fees may apply. 	<input type="checkbox"/> Yes
One-line diagram <ul style="list-style-type: none"> • This one-line diagram must be signed and stamped by a Professional Engineer licensed in Minnesota if the DER is uncertified greater than 20 kW AC or if certified system is over 250 kW. • Details required on one-line diagram specified at the end of the interconnection application and in Local Utility’s Technical Specifications Manual (TSM) 	<input type="checkbox"/> Yes
Schematic drawings for all protection and control circuits, relay current circuits, relay potential circuits, and alarm/monitoring circuits	<input type="checkbox"/> Yes
Inverter Specification Sheet(s) (if applicable)	<input type="checkbox"/> Yes
Documentation that describes and details the operation of protection and control schemes	<input type="checkbox"/> Yes
Documentation showing site control	<input type="checkbox"/> Yes
Aerial map showing DER system layout including major roadways and true north (See TSM for more details)	<input type="checkbox"/> Yes
<u>Possible Additional Documentation (See TSM for more details)</u>	
<ul style="list-style-type: none"> • If the DER export capacity is limited, include information material explaining the limiting capabilities. • If Energy Storage is included with the proposed DER system, include the Energy Storage Application. 	

General *	
Select Review Process: <input type="checkbox"/> Fast Track Process <input type="checkbox"/> Study Process	
Application is for:	<input type="checkbox"/> New Distributed Energy Resource <input type="checkbox"/> Capacity Addition or Material Modification to Existing Distributed Energy Resource
If Capacity Addition or Material Modification to existing facility, please describe:	
Distributed Energy Resource will be used for what reason? (Check all that apply):	
<input type="checkbox"/> Net Metering <input type="checkbox"/> Supply Power to Interconnection Customer <input type="checkbox"/> Supply Power to Area EPS	
Installed DER System Cost (before incentives):	\$

Interconnection Customer *		
Full Name (must match the name of the existing service account):		
Account Number:	Meter Number:	
Mailing Address:		
City:	State:	Zip Code:
Email:	Phone:	

** Indicates section must be completed.*

Application Agent *	
Is the Customer using an Application Agent for this application?	<input type="checkbox"/> Yes <input type="checkbox"/> No
<i>If Interconnection Customer is not using an Application Agent, please skip to the next section.</i>	
Application Agent:	
Company Name:	
Email:	Phone:

Distributed Energy Resource Information *	
Estimated Installation Date:	
Location (if different from mailing address of Interconnection Customer):	
Will the Proposed DER system be interconnected to an existing electric service?	<input type="checkbox"/> Yes <input type="checkbox"/> No
Is the Distributed Energy Resource a single generating unit or multiple?	<input type="checkbox"/> Single <input type="checkbox"/> Multiple
DER Type (<i>Check all that apply</i>):	
<input type="checkbox"/> Solar Photovoltaic	<input type="checkbox"/> Wind
<input type="checkbox"/> Combined Heat and Power	<input type="checkbox"/> Solar Thermal
	<input type="checkbox"/> Energy Storage
	<input type="checkbox"/> Other (please specify)
<i>DER systems with Energy Storage must also submit the Energy Storage Application to the Local Utility.</i>	
Total Number of Distributed Energy Resources to be interconnected pursuant to this Interconnection Application:	
Phase configuration of Distributed Energy Resource(s):	<input type="checkbox"/> Single Phase <input type="checkbox"/> Three Phase
Type of Generator:	<input type="checkbox"/> Inverter <input type="checkbox"/> Synchronous <input type="checkbox"/> Induction
Aggregate DER Capacity (the sum of nameplate capacity of all generation and storage devices at the PCC):	
kW_{ac}	kVA_{ac}

** Indicates section must be completed.*

Export Capacity Limitation *	
Is the export capability of the DER limited?	<input type="checkbox"/> Yes <input type="checkbox"/> No
<i>If the DER export capacity is limited, complete the following sections and include information material to explaining the limiting capabilities.</i>	
Maximum Physical Export Capacity Requested:	kW_{ac}
If Yes, please provide additional details describing method of export limitation:	

Load Information *	
Interconnection Customer's or Customer-sited Load:	kW_{ac}
Typical Reactive Load (if known):	

Equipment Certification *	
Is the DER equipment certified? ¹	<input type="checkbox"/> Yes <input type="checkbox"/> No
<i>Please list all IEEE 1547 certified equipment below. Include all certified equipment manufacturer specification sheets with the Interconnection Application submission.</i>	
Equipment Type	Certifying Entity
1	
2	
3	
4	

* Indicates section must be completed.

¹ Information regarding certified equipment can be found in Section 14 of the Process Overview (Chapter 4), the Technical Specifications Manual (Chapter 8), and the Minnesota Technical Interconnection and Interoperability Requirements approved by the Minnesota Public Utilities Commission in Docket No. E-999/CI-16-521.

Prime Mover *		
Please indicate the prime mover:		
<input type="checkbox"/> Solar Photovoltaic	<input type="checkbox"/> Microturbine	<input type="checkbox"/> Fuel Cell
<input type="checkbox"/> Reciprocating Engine	<input type="checkbox"/> Gas Turbine	<input type="checkbox"/> Other (please specify)
Is the prime mover compatible with certified protection equipment package?		<input type="checkbox"/> Yes <input type="checkbox"/> No
DER Manufacturer:	Model Name & Number:	Version:
List of Adjustable Set Points for Protection Equipment or Software:		
Summer Name Plate Rating:	kW_{ac}	Summer Name Plate Rating: kW_{ac}
Winter Name Plate Rating:	kVA_{ac}	Winter Name Plate Rating: kVA_{ac}
Rated Power Factor:	Leading:	Lagging:
<i>A completed Power System Load Flow data sheet must be supplied with the Interconnection Application.</i>		

Only appropriate sections beyond this point until the signature page are to be completed.

Distributed Energy Resource Characteristic Data (for Inverter-based machines)	
Max design fault contribution current:	
Is your response to the previous field an Instantaneous or RMS measurement?	<input type="checkbox"/> Instantaneous <input type="checkbox"/> RMS
Harmonic Characteristics:	
Start-up Requirements:	

** Indicates section must be completed.*

Distributed Energy Resource Characteristic Data (for Synchronous machines)	
RPM Frequency:	Neutral Grounding Resistor:
Direct Axis Synchronous Reactance, X_d :	Zero Sequence Reactance, X_0 :
Direct Axis Transient Reactance, X'_d :	KVA Base:
Direct Axis Subtransient Reactance, X''_d :	Field Volts:
Negative Sequence Reactance, X_2 :	Field Amperes:
Please provide the appropriate IEEE model block diagram of excitation system, governing system and power system stabilizer (PSS) in accordance with the regional reliability council criteria. A PSS may be determined to be required by applicable studies. A copy of the manufacturer's block diagram may not be submitted.	

Distributed Energy Resource Characteristic Data (for Induction machines)	
RPM Frequency:	Neutral Grounding Resistor:
Motoring Power (kW):	Exciting Current:
Heating Time Constant:	Temperature Rise:
Rotor Resistance, R_r :	Frame Size:
Stator Resistance, R_s :	Design Letter:
Stator Reactance, X_s :	Reactive Power Required In Vars (No Load):
Rotor Reactance, X_r :	Reactive Power Required In Vars (Full Load):
Magnetizing Reactance, X_m :	Total Rotating Inertia, H:
Short Circuit Reactance, X''_d :	

Interconnection Facilities Information			
Will a transformer be used between the DER and the Point of Common Coupling?		<input type="checkbox"/> Yes <input type="checkbox"/> No	
Will the transformer be provided by the Interconnection Customer? If yes, please fill in the fields below.		<input type="checkbox"/> Yes <input type="checkbox"/> No	
Proposed location of protective interface equipment on property:			
Transformer Data (For Interconnection Customer-Owned Transformer)			
What is the phase configuration of the transformer?		<input type="checkbox"/> Single Phase <input type="checkbox"/> Three Phase	
Size (kVA):	Transformer Impedance (%):	On kVA Base:	
Transformer Volts: (Primary)	Delta:	Wye:	Wye Grounded:
Transformer Volts: (Secondary)	Delta:	Wye:	Wye Grounded:
Transformer Volts: (Tertiary)	Delta:	Wye:	Wye Grounded:
Transformer Fuse Data (For Interconnection Customer-Owned Fuse)			
Manufacturer:	Type:	Size:	Speed:
Interconnecting Circuit Breaker (For Interconnection Customer-Owned Circuit Breaker)			
Manufacturer:		Type:	
Load Rating (in Amps):	Interrupting Rating (In Amps):	Trip Speed (Cycles):	
Interconnection Protective Relays (For Microprocessor Controlled Relays)			
Setpoint Function		Minimum	Maximum

Interconnection Protective Relays (For Relays with Discrete Components)			
Manufacturer:	Type:	Style/Catalog No.:	Proposed Setting:
Manufacturer:	Type:	Style/Catalog No.:	Proposed Setting:
Manufacturer:	Type:	Style/Catalog No.:	Proposed Setting:
Manufacturer:	Type:	Style/Catalog No.:	Proposed Setting:
Manufacturer:	Type:	Style/Catalog No.:	Proposed Setting:
Current Transformer Data:			
Manufacturer:	Type:	Accuracy Class:	Proposed Ratio Connection:
Manufacturer:	Type:	Accuracy Class:	Proposed Ratio Connection:
Potential Transformer Data:			
Manufacturer:	Type:	Accuracy Class:	Proposed Ratio Connection:
Manufacturer:	Type:	Accuracy Class:	Proposed Ratio Connection:

For Office Use Only	
Application ID:	
Date Received:	Application Fee Received: <input type="checkbox"/> Yes <input type="checkbox"/> No
Date Completed:	

Interconnection Agreement *

Proposed DER interconnections that are also deemed Qualifying Facilities less than 40 kW AC under Minnesota Statutes § 216B.164 are eligible to sign the Local Utility’s Standard Agreement for Cogeneration and Small Power Production Facilities. Included in this agreement are payment terms for excess power generated by the proposed DER system the Local Utility may purchase. In lieu of the Local Utility’s Standard Agreement for Cogeneration and Small Power Production Facilities, the Interconnection Customer may choose to instead sign the Local Utility’s Interconnection Agreement.

The Interconnection Customer requests an Interconnection Agreement to be executed in lieu of the Local Utility’s Standard Agreement for Cogeneration and Small Power Production Facilities.

Yes No

Disclaimers – Must be completed by Interconnection Customer *

	Initials
The Interconnection Customer has opportunities to request a timeline extension during the interconnection process. Failure by the Interconnection Customer to meet or request an extension for a timeline outlined in the Interconnection Process could result in a withdrawn queue position and the need to re-apply.	
Proposed DER interconnections to the Local Utility’s distribution system submitted under the Fast Track Process may be moved into the Study Process if engineering screens are failed during the Interconnection Application review.	

Application Signature – Must be completed by Interconnection Customer *

I designate the individual or company listed as my Application Agent to serve as my agent for the purpose of coordinating with the Area EPS Operators on my behalf throughout the interconnection process.

_____ Initials

I hereby certify that, to the best of my knowledge, the information provided in this Application is true, and that I have appropriate Site Control in conformance with the Interconnection Process. I agree to abide by the Minnesota Interconnection Process (MIP) and will inform the Local Utility if the proposed DER system changes from the details listed in this Interconnection Application.

Applicant Signature:

Date:

*****Please print clearly or type and return completed along with any additional documentation*****

Information Required on One-Line Diagram

An Interconnection Application must include a site electrical one-line diagram showing the configuration of all Distributed Energy Resource equipment, current and potential circuits, and protection and control schemes. The one-line diagram shall include:

- Applicant name.
- Application ID.
- Installer name and contact information.
- Address where DER system will be installed - must match application address.
 - Be sure to list the address for the protective interface equipment if the protective interface equipment is located at a different address than the DER system.
- Correct positions of all equipment, including but not limited to panels, inverter, and DC/AC disconnect. Include distances between equipment, and any labeling found on equipment.
- Any other information that may be required by the Local Utility's Technical Specifications Manual

This one-line diagram must be signed and stamped by a Minnesota licensed Professional Engineer if the Distributed Energy Resource is larger than 20 kW (if uncertified) and 250 kW (if certified.)

Please see the Local Utility's Technical Specifications Manual for example one-line diagram.

**INTERCONNECTION AND POWER PURCHASE AGREEMENT –
100 kW or Less (MN STANDARD AGREEMENT)**

This Interconnection and Power Purchase Agreement – 100 kW or Less (MN Standard Agreement) (the “Agreement”) is made and entered into _____, 20__, by and among Missouri Basin Municipal Power Agency, d/b/a Missouri River Energy Services, 3724 West Avera Drive, PO Box 88920, Sioux Falls, SD 57109-8920, a body politic and corporate and public agency organized in Iowa and existing under the laws of the States of Iowa, Minnesota, North Dakota and South Dakota (“MRES”), _____, [Address] (“Local Utility”), and _____, with an address as set forth in Exhibit A hereto (“Customer”). MRES, Local Utility and Customer are each individually referred to herein as a “Party” and collectively as the “Parties.”

RECITALS

A. Customer has installed, or plans to install, electric generating facilities rated at 100 kilowatts or less of electricity on certain real property owned or leased by Customer, which facilities and property are more particularly described in the MN Interconnection Application attached to this Agreement as Exhibit A. The generating facilities are hereinafter referred to as the “Qualifying Facility”.

B. Local Utility is a municipal utility that owns and operates an electrical distribution system (the “Local Utility System”) and provides retail electric power to Customer and other customers.

C. MRES is a joint action agency that supplies wholesale electric power supply to Local Utility pursuant to a long-term exclusive supply contract that requires Local Utility to purchase from MRES all electric power supply in excess of that provided by the Western Area Power Administration.

D. Pursuant to a waiver/agreement with the Federal Energy Regulatory Commission under the Public Utility Regulatory Policies Act (“PURPA”), MRES is required to purchase power from “qualifying facilities,” as defined by PURPA, and Local Utility is required to interconnect, supply power to, and allow qualifying facilities to operate in parallel with the Local Utility System. MRES and Local Utility are also permitted, but not required, to take such actions with respect to electric generating facilities which do not constitute “qualifying facilities” under PURPA.

E. Customer desires to interconnect and operate the Qualifying Facility in parallel with the Local Utility System and sell power generated by the Qualifying Facility to MRES, and Local Utility and MRES are willing to do so pursuant to the terms and conditions of this Agreement.

NOW, THEREFORE, the Parties hereby agree as follows:

1. Scope and Purpose. This Agreement sets forth the terms and conditions under which the Qualifying Facility may be interconnected to, and operated in parallel with, the Local

Utility System and under which MRES will purchase electrical energy generated by the Qualifying Facility. This Agreement does not constitute an agreement by MRES or Local Utility to deliver electrical energy generated by the Qualifying Facility or to provide any services to Customer except as described in this Agreement.

2. Interconnection Rules. The procedures and technical requirements governing the interconnection and operation of the Qualifying Facility are described in the documents of Local Utility entitled “MN Interconnection Process” (the “Procedures”) and “Technical Specifications Manual” (the “Requirements”), each as may be amended by Local Utility from time to time (collectively, the “Interconnection Rules”). Local Utility shall have the right to amend the Interconnection Rules from time to time in its sole discretion. The Interconnection Rules are incorporated and made part of this Agreement by this reference. Customer acknowledges it has received a copy of the Interconnection Rules and agrees to comply with the terms of the Interconnection Rules. In the event any terms of this Agreement conflict with the terms of the Interconnection Rules, the terms of this Agreement shall govern. All capitalized terms used in this Agreement shall have the meanings given them in the Interconnection Rules, unless otherwise expressly provided herein.

3. Point of Common Coupling. The point where the Interconnection Facilities connect with the Local Utility System is the Point of Common Coupling (“PCC”) as shown on the diagram in Exhibit A. The diagram included in Exhibit A shall depict the PCC, the location of meter(s), the point of delivery, and such other detail as may be required by Local Utility. Customer and Local Utility shall interconnect the Qualifying Facility to the Local Utility System at the PCC in accordance with the Interconnection Rules and all applicable laws, regulations and prudent utility practices. Local Utility and Customer shall each own and be responsible for the installation, maintenance and repair of the lines, wires, switches and other equipment on their respective sides of the PCC. Unless otherwise specified in Exhibit B, Customer, at its cost, shall furnish, install, own, maintain and repair all interconnection equipment required at the PCC, in accordance with the Interconnection Rules and applicable laws, regulations and prudent utility practices. Final electrical connections between the Local Utility System and the Qualifying Facility shall be made by Local Utility.

4. Installation, Operation and Maintenance of Qualifying Facility. Customer shall install, operate and maintain the Qualifying Facility in accordance with the terms of this section.

a. Responsibility; Standards. Customer shall install, operate, maintain, repair and inspect the Qualifying Facility and shall be fully responsible for the Qualifying Facility, unless otherwise provided herein. Customer’s installation, operation, maintenance and repair of the Qualifying Facility shall be in accordance with this Agreement, the Interconnection Rules, all applicable laws, regulations, ordinances and building codes, and, as applicable, the National Electrical Safety Code (“NEC”), American National Standards Institute (“ANSI”), Institute of Electrical and Electronic Engineers (“IEEE”), National Electrical Code (“NEC”), and Underwriter’s Laboratory (“UL”). In addition, Customer shall maintain the Qualifying Facility in accordance with applicable manufacturers’ recommended maintenance schedules.

b. Costs. Unless otherwise specified in Exhibit B, Customer shall be responsible for all costs associated with the Qualifying Facility, including all costs of installation, operation, maintenance, inspection and repair. Customer shall pay for the actual cost of the Interconnection Facilities and Distribution Upgrades along with Local Utility's cost to commission the proposed DER system. An estimate of the interconnection costs are set forth in Exhibit B.

c. Permits. Prior to installation of the Qualifying Facility, Customer shall obtain all environmental and other permits required by any governmental authorities to install, own and operate the Qualifying Facility. Customer shall maintain and comply with the requirements of all such permits during the term of this Agreement.

d. Disruption to Local Utility System. Customer shall design, install, equip, maintain, operate and repair the Qualifying Facility to ensure that the Local Utility System and Local Utility's service to other customers are not adversely affected by the Qualifying Facility, either due to disruptions to the Local Utility System or power quality issues.

e. Alterations. Customer shall not alter, modify or add to the Qualifying Facility without receiving a prior written determination of Local Utility, in accordance with the Interconnection Rules, as to whether the proposed alteration, modification or addition constitutes a Material Modification to the Interconnection Application. Not less than twenty (20) days prior to the commencement of any proposed alteration, modification or addition to the Qualifying Facility, Customer shall notify Local Utility of the proposal and provide Local Utility with all information reasonably required by Local Utility to review such proposal, including any change in generation capacity of the Qualifying Facility and any alterations to applicable interconnection equipment. Local Utility shall have ten (10) days to notify Customer in writing of Local Utility's final determination of the proposed modification.

f. Operator in Charge. Customer shall identify an individual (by name or title) who will act as "Operator in Charge" of the Qualifying Facility. This individual must be familiar with the terms of this Agreement, the Interconnection Rules, and any other laws, regulations or agreements that may apply to the Qualifying Facility.

5. Electric Service. Local Utility shall provide electric service to Customer for the electricity requirements of Customer not supplied by the Qualifying Facility. Such electric service shall be supplied by Local Utility under the rules and rate schedules of Local Utility applicable to Customer's class of service, as revised from time to time by Local Utility in its sole discretion.

6. Metering.

a. Metering Equipment. Local Utility shall purchase, own, install and maintain such metering equipment as is necessary to meter all electrical energy of the Qualifying Facility delivered to the Local Utility System, consistent with the metering arrangement elected pursuant to subsection (b) below. The metering equipment and cost responsibilities associated with such equipment are set forth in Exhibit B. Local Utility shall test the metering equipment on a scheduled basis. If the metering equipment fails to

register proper amounts or the registration thereof becomes so erratic as to be meaningless, the energy delivered to the Local Utility System shall be determined by Local Utility from the best information available.

b. Metering Arrangement. The metering arrangement used to meter and record electrical energy delivered from the Qualifying Facility to the Local Utility System, and from the Local Utility to Customer, shall be as set forth in attached Exhibit B.

7. Testing. Customer shall test the Qualifying Facility and interconnection equipment and provide to Local Utility all records of testing in accordance with the Interconnection Rules. Such testing shall occur prior to commencement of operation of the Qualifying Facility and periodically thereafter, in accordance with the Interconnection Rules or as otherwise requested by Local Utility. Local Utility and MRES shall have the right to witness all field testing and review all records prior to allowing the Qualifying Facility to commence normal operations. Such tests are for purposes of assuring the protection and operation of the Local Utility System and in no way represent any assurance of protection and operation of the Qualifying Facility.

8. Right of Access; Inspection. Local Utility and MRES shall have the right to inspect the Qualifying Facility and observe the Qualifying Facility's installation, commissioning, startup, operation and maintenance. Local Utility and MRES shall have access to the Qualifying Facility for any reasonable purpose in connection with the interconnection described in this Agreement or the Interconnection Rules or to provide service to other customers.

9. Disconnection. The Qualifying Facility shall or may be disconnected from the Local Utility System at such times as described in, and in accordance with, the terms of this section.

a. Disconnection by Customer. Customer shall disconnect the Qualifying Facility from the Local Utility System upon the effective date of the termination of this Agreement as described in Section 15 below.

b. Disconnection by Local Utility. Local Utility shall have the right to disconnect, or cause Customer to disconnect, the Qualifying Facility from the Local Utility System for the following reasons: (i) to allow Local Utility to operate, construct, install, maintain, repair, replace or inspect any facilities of Local Utility; (ii) the disruption or potential disruption of the Local Utility System as described in Section 4(d) above; (iii) the presence of a condition which could cause injury or loss of life or damage to the Local Utility System or property of a third party; (iv) if Local Utility is required to disconnect by MRES or Local Utility's transmission provider; (v) Customer's noncompliance with the terms of this Agreement; (vi) the termination of this Agreement as provided in Section 15 below; or (vii) any other reason for disconnection as set forth in the Interconnection Rules. Local Utility shall use reasonable efforts to provide prior notice and coordination of any disconnection of the Qualifying Facility due to routine maintenance, repairs or modifications to the Local Utility System. Neither Local Utility nor MRES shall be liable to Customer for any damages, losses or other liabilities, including consequential damages, due to the disconnection of the Qualifying Facility as described in this section.

10. Interconnected Operation. Customer may operate interconnected with the Local Utility System only in accordance with this Agreement and the Interconnection Rules. Local Utility, MRES and Customer shall comply with all requirements of the transmission provider and any regulatory authorities having jurisdiction over distributed generation interconnected to the Local Utility System.

11. Energy Sales to MRES. MRES shall purchase all electrical energy generated by the Qualifying Facility which is received by the Local Utility System. The rate paid by MRES for such electrical energy shall be equal to the sum of: (a) the MRES PURPA rate for qualifying facilities of 100 kW or less, as adjusted from time to time by MRES in its discretion, and (b) the Loss Factor Adjustment, as adjusted from time to time by MRES and Local Utility in their discretion. The MRES PURPA rate and the Loss Factor Adjustment, along with their currently applicable amounts, are described in attached Exhibit B. Customer shall receive payment for electrical energy sales to MRES through a credit on Customer's monthly invoice from Local Utility, which credit may be one month in arrears. MRES, in turn, shall credit the monthly wholesale power supply bill submitted by MRES to Local Utility in an amount equal to the electrical energy purchases of MRES from the Qualifying Facility during the preceding month. Local Utility shall provide to MRES, as soon as available following the end of each month, data indicating the amount of electrical energy purchased by MRES from the Qualifying Facility during the preceding month.

12. Limitation of Liability. Each Party's liability to the other Parties for any loss, cost, claim, injury, liability, or expense, including reasonable attorney's fees, relating to or arising from any act or omission in its performance of its obligations under this Agreement shall be limited to the amount of direct damage actually incurred. In no event shall a Party be liable to another party under this Agreement for any punitive, incidental, indirect, special or consequential damages, including for loss of business opportunity or profits. In addition, and notwithstanding any other provision in this Agreement, Local Utility's liability to Customer under this Agreement shall be further limited as set forth in Local Utility's tariffs and/or terms and conditions for electric service, which limitations are incorporated herein by this reference.

13. Insurance. Customer shall maintain general liability insurance in accordance with the terms of the Interconnection Rules.

14. Default; Remedies. A Party shall be in default under this Agreement if such Party fails to comply with, observe or perform, or defaults in the performance of, any covenant or obligation under this Agreement and fails to cure the failure within thirty (30) days after receiving written notice from another Party, which notice shall identify the basis of the default. If a default is not cured within the cure period, the non-defaulting Party or Parties shall have the right to terminate this Agreement by written notice to the defaulting Party, shall be relieved of any further obligation under this Agreement, and shall be entitled to pursue all other damages and remedies available under this Agreement or at law or in equity.

15. Term. This Agreement shall take effect upon execution by all Parties hereto and shall remain in effect unless terminated in accordance with this section. This Agreement may be terminated as follows: (a) any Party may terminate this Agreement at any time upon ninety (90) days' written notice to the other Parties; (b) Local Utility or MRES may terminate this Agreement

at any time upon thirty (30) days' written notice to the other Parties if the Qualifying Facility is not, or at any time ceases to be, a "qualifying facility" under PURPA; (c) any Party may terminate this Agreement after a default under Section 14 above; and (d) MRES may terminate this Agreement upon sixty (60) days' written notice to the other Parties in the event MRES determines that its purchase of electrical energy generated by the Qualifying Facility under Section 11 above would result in cost greater than those which MRES would incur if it did not make such purchases, as permitted by the PURPA waiver/agreement described in Recital D above. In the event this Agreement is terminated pursuant to subsection (d), Local Utility and Customer shall enter into a new agreement which defines their respective rights and obligations with respect to the interconnection and operation of the Qualifying Facility to and with the Local Utility System in accordance with PURPA.

16. Force Majeure. For purposes of this Agreement, a force majeure event is any event that is beyond the reasonable control of the affected Party and that the affected Party is unable to prevent by exercising reasonable diligence, including the following events or circumstances, but only to the extent they satisfy the preceding requirements: acts of war, terrorism, public disorder, rebellion or insurrection; floods, hurricanes, earthquakes, lightning, storms or other acts of God; explosions or fires; strikes, work stoppages or labor disputes; embargoes; and sabotage. If a force majeure event prevents a Party from fulfilling its duties under this Agreement, such Party shall promptly notify the other Party in writing and shall keep the other Party informed on a continuing basis of the scope and duration of the force majeure event. The affected Party shall specify the circumstances of the force majeure event, its expected duration, and the steps being taken to mitigate the effect of the event. The affected Party shall be entitled to suspend or modify its performance under this Agreement but will use reasonable efforts to resume its performance as soon as possible.

17. Non-Warranty. Neither by inspection, if any, nor by non-rejection or in any other way does Local Utility or MRES give or make any warranty, express or implied, as to the adequacy, safety or other characteristics of any lines, wires, switches, or other equipment or structures owned, installed or maintained by Customer.

18. Assignment. Customer may assign this Agreement to an entity or individual to whom Customer transfers ownership of the Qualifying Facility, so long as Customer obtains prior written consent of Local Utility and MRES, which consent shall not be unreasonably withheld, and such assignee agrees in writing to assume all obligations of Customer under this Agreement. Local Utility and/or MRES may assign this Agreement upon written notice to Customer.

19. No Waiver. The failure of a Party to insist, on any occasion, upon strict performance of any provision of this Agreement shall not be construed as a waiver or relinquishment of the obligations, rights or duties imposed upon the Parties.

20. Notices. Notices given under this Agreement shall be deemed to have been given when delivered in person or by mail, postage prepaid, to the respective addresses of the Parties set forth in the opening paragraph of this Agreement. Such addresses may be changed by written notification to the other Parties.

21. Severability. If any provision of this Agreement is adjudged by any court of competent jurisdiction to be illegal or unenforceable, such provision shall be deemed separate and independent, and the remainder of this Agreement shall remain in full force and effect.

22. Entire Agreement; Amendments. This Agreement, including the Interconnection Rules and all Exhibits hereto, constitutes the entire agreement and understanding between the Parties concerning the subject matter of this Agreement. The Parties are not bound by or liable for any statement, representation, promise, understanding or undertaking of any kind or nature, whether written or oral, with regard to the subject matter hereof not set forth or provided for herein. It is expressly acknowledged that the Parties may have other agreements covering other services not expressly provided for in this Agreement, which agreements are unaffected by this Agreement. This Agreement may be amended only upon mutual agreement of the Parties, which amendment will not be effective until reduced to writing and executed by the Parties.

23. Dispute Resolution. The city council or city-appointed body governing the Local Utility has authority to consider and determine disputes, if any, that arise under this Agreement. The Parties agree to use good faith efforts to resolve all disputes in accordance with the dispute resolution process adopted by the Local Utility's governing body pursuant to Minnesota Statutes §216B.164.

24. Governing Law; Jurisdiction. This Agreement and the rights and obligations of the Parties hereunder shall be construed in accordance with and shall be governed by the laws of the State of Minnesota.

[Signature Page Follows]

IN WITNESS WHEREOF, the Parties have caused this Interconnection and Power Purchase Agreement – 100 kW or Less (Standard Agreement) to be signed by their respective duly authorized representatives.

[LOCAL UTILITY NAME]

[CUSTOMER NAME]

BY: _____
TITLE: _____
DATE: _____

BY: _____
TITLE: _____
DATE: _____

MISSOURI BASIN MUNICIPAL POWER AGENCY
d/b/a MISSOURI RIVER ENERGY SERVICES

BY: _____
TITLE: _____
DATE: _____

EXHIBIT A
INTERCONNECTION APPLICATION

EXHIBIT B
METERING ARRANGEMENT AND PURCHASE RATE

1. MRES PURPA Rate. The rate to be paid by MRES for electrical energy purchased from the Qualifying Facility under Section 11 of the Agreement shall be equal to the MRES PURPA rate for 100 kW or less, as established by MRES in its sole discretion each year or upon other intervals as determined by MRES. The MRES PURPA rate for 100 kW or less for 20__ is \$_____/kWh. MRES shall notify Local Utility, and Local Utility shall notify Customer, of any change in such rate adopted by MRES. Customer's right to payments under Section 11 is subject to Customer's compliance with the terms, covenants and conditions of the Agreement.

2. Loss Factor Adjustment. The MRES PURPA rate for 100 kW or less, as described in Section 1 above, shall be increased by a percentage factor to reflect the savings resulting from reduced Local Utility System losses associated with electrical energy purchased from the Qualifying Facility under Section 11 of the Agreement. For example, if the Loss Factor Adjustment was 5%, the Loss Factor Adjustment to the 20__ MRES PURPA rate, in dollars, would be \$____ (\$_____ x 0.05), causing the total combined rate paid for power purchased from the Qualifying Facility to be \$_____/kWh. Local Utility and MRES shall establish the Loss Factor Adjustment each year or upon other intervals as they determine, and Local Utility shall notify Customer of any change in this factor. The Loss Factor Adjustment for 20__ is _____%.

3. Metering Arrangement.

a. Less than 40 kW QFs. A customer with a Qualifying Facility with a capacity of less than 40 kW can elect one of the following metering arrangements to measure the electrical energy generated by the Qualifying Facility which is received by the Local Utility System for purchase by MRES (Customer to select one):

_____. Net Metering. The metering shall be such that power delivered to Customer by Local Utility shall be netted against power received by Local Utility from the Qualifying Facility, pursuant to Minnesota Rules § 7835.3300. Local Utility's monthly invoice to Customer will indicate: (a) a credit to Customer if the power received by Local Utility from the Qualifying Facility exceeds the power provided by Local Utility to Customer or (b) the payment due by Customer to Local Utility if the power delivered by Local Utility to Customer exceeds the power received by Local Utility from the Qualifying Facility. The rate to be used to determine payment under subsection (a) for any net excess power received by the Local Utility System shall be the rate described in Section 11 of the Agreement.

_____. Dual Metering. The metering shall be such that all power received by the Local Utility from the Qualifying Facility (net of Customer's own use) shall be measured separately from power delivered from Local Utility to Customer, pursuant to Minnesota Rules § 7835.3400. The meter measuring power delivered to Customer shall not permit

reduction of measured power already delivered to Customer during periods when the Qualifying Facility generation exceeds Customer demand (i.e. no netting allowed). Local Utility shall credit Customer's monthly bill for power received by the Local Utility System and purchased by MRES. The rate paid by MRES for electrical energy generated by the Qualifying Facility which is received by the Local Utility System shall be the rate described in Section 11 of the Agreement.

b. 40 kW to 100 kW QFs. If the capacity of Customer's Qualifying Facility is 40 kW or more and less than or equal to 100 kW, then the metering arrangement to measure the electrical energy generated by the Qualifying Facility which is received by the Local Utility System for purchase by MRES shall be such that all power received by the Local Utility from the Qualifying Facility (net of Customer's own use) shall be measured separately from power delivered from Local Utility to Customer, pursuant to Minnesota Rules § 7835.3400. The meter measuring power delivered to Customer shall not permit reduction of measured power already delivered to Customer during periods when the Qualifying Facility generation exceeds Customer demand (i.e. no netting allowed). Local Utility shall credit Customer's monthly bill for power received by the Local Utility System and purchased by MRES. The rate paid by MRES for electrical energy generated by the Qualifying Facility which is received by the Local Utility System shall be the rate described in Section 11 of the Agreement.

c. Customer acknowledges and agrees that time-of-day purchase rates under Minnesota Rules § 7835.3500 are not available under this Agreement due to metering and technology limitations of Local Utility and Customer.

4. Environmental Attributes. Power purchased by MRES from the Qualifying Facility does not include any environmental attributes (i.e., renewable energy credits), if any, associated with the environmental character of the Qualifying Facility, nor any federal income tax credits for renewable energy that are accruable to Customer with respect to the Qualifying Facility.

5. Interconnection Costs. The Qualifying Facility is responsible for the actual, reasonable costs of interconnection which are estimated to be \$_____. The Qualifying Facility will pay Local Utility as follows:

_____.

6. Metering Equipment. Local Utility is responsible for furnishing the following metering equipment, if any: _____. Local Utility's cost responsibility, if any, associated with the metering equipment is as follows:

_____.

INTERCONNECTION AGREEMENT

For use in lieu of the MN Standard
Agreement

Contents

i.	Contact Information	1
1	Scope and Limitations of Agreement	2
2	Responsibilities of the Parties	3
3	Parallel Operation Obligations	4
4	Metering	4
5	Distributed Energy Resource Capabilities and Grid Reliability	4
6	Equipment Testing and Inspection	5
7	Authorization Required Prior to Parallel Operation	5
8	Right of Access	5
9	Term and Termination	6
10	Disconnection	7
11	Cost Responsibility for Interconnection Facilities and Distribution Upgrades	9
12	Cost Responsibility for Network Upgrades	9
13	Billing, Payment, Milestones, and Financial Security	11
14	Assignment	12
15	Limitations of Liability	12
16	Non-Warranty	13
17	Indemnity	13
18	Force Majeure	14
19	Default	14
20	Insurance	14
21	Confidential Information	15
22	Disputes	15
23	Taxes	15
24	Miscellaneous	15
25	Notices	18
26	Signatures	21

Attachment I: Glossary of Terms.....	22
Attachment II: Description and Costs of the Distributed Energy Resource, Interconnection Facilities, and Metering Equipment	28
Attachment III: One-line Diagram Depicting the Distributed Energy Resource, Interconnection Facilities, and Metering Equipment, and Upgrades.....	29
Attachment IV: Milestones.....	30
Attachment V: Operating Agreement	32
Attachment VI: Maintenance Agreement.....	36
Attachment VII: Area EPS Operator’s Description of Distribution and Network Upgrades and Good Faith Estimates of Upgrade Costs.....	37
Attachment VIII: Assignment of Interconnection Agreement	38

i. Contact Information

Contact information for each Party is listed below along with the basic information describing the Distributed Energy Resource (DER) system.

Area EPS Operator Information

Area EPS Operator: _____
Attention: _____
Address: _____

Phone: _____
Email: _____

Interconnection Customer Information

Interconnection Customer: _____
Attention: _____
Address: _____

Phone: _____
Email: _____

DER System Information

Application Number: _____
Type of DER System: _____
Capacity Rating of System (AC): _____
Limited Capacity Rating (AC): _____
Address of DER System: _____

This Interconnection Agreement (“Agreement”) is made and entered into this ____ day of _____, 20__ by and between _____ (“Interconnection Customer”), and _____, a municipal utility existing under the laws of the State of Minnesota (“Area EPS Operator”). Interconnection Customer and Area EPS Operator each may be referred to as a “Party” or collectively as the “Parties.”

In consideration of the mutual covenants set forth herein, the Parties agree as follows:

1 Scope and Limitations of Agreement

- 1.1. This Agreement is intended to provide for the Interconnection Customer to interconnect at the Point of Common Coupling and operate a Distributed Energy Resource with a Nameplate Rating of 10 Megawatts (MW) or less in parallel with the Area EPS at the location identified above and shown in the one-line diagram in Attachment 3.
- 1.2. This Agreement shall be used for all Interconnection Applications submitted under the Minnesota Interconnection Process (MIP) except for those Interconnection Applications that qualify and choose for the MN Standard Agreement to replace the need for this Agreement.
- 1.3. This Agreement governs the terms and conditions under which the Interconnection Customer’s Distributed Energy Resource will interconnect with, and operate in parallel with, the Area EPS Operator’s Distribution System.
- 1.4. Capitalized terms used herein shall have the meanings specified in the Glossary of Terms in Attachment 1, the MIP, or the body of this Agreement.
- 1.5. This Agreement does not constitute an agreement to purchase or deliver the Interconnection Customer’s power. The purchase or delivery of power and other services that the Interconnection Customer may require from the Area EPS Operator, or others, may be covered under separate agreements.
- 1.6. To facilitate the operation of the Distributed Energy Resource, this Agreement also allows for the occasional and inadvertent export of energy to the Area EPS. The amount, metering, billing, and accounting of such inadvertent energy exporting shall be governed by the Operating Agreement in Attachment 5. This Agreement does not constitute an agreement by the Area EPS Operator to purchase or to pay for any energy, inadvertently or intentionally exported, unless expressly noted in Attachment 5 or under a separately executed power purchase agreement (PPA).

- 1.7. This Agreement does not constitute a request for the provision of any transmission delivery service or for any local distribution delivery service. If it is the Interconnection Customer's intent to sell to other parties, the Interconnection Customer shall be responsible for market related charges to the Area EPS Operator or its wholesale power supplier caused by the generator operation.
- 1.8. The Minnesota Technical Requirements for interconnection are covered in a separate document, a copy of which has been made available to the Interconnection Customer and is incorporated and made part of this Agreement by this reference.
- 1.9. Nothing in this Agreement is intended to affect any other agreement between the Area EPS Operator and the Interconnection Customer.

2 Responsibilities of the Parties

- 2.1. The Parties shall perform all obligations of this Agreement in accordance with the MIP, Minnesota Technical Requirements, all Applicable Laws and Regulations, Operating Requirements, and Good Utility Practice.
- 2.2. The Interconnection Customer shall construct, interconnect, operate and maintain its Distributed Energy Resource and construct, operate, and maintain its Interconnection Facilities in accordance with the applicable manufacturer's recommended maintenance schedule, this Agreement, and Good Utility Practice. Prior to the construction of the Distributed Energy Resource, the Interconnection Customer shall obtain all environmental and other permits required by any governmental authorities. The Interconnection Customer shall also maintain and comply with the requirements of these permits during the term of this Agreement.
- 2.3. The Area EPS Operator shall construct, operate, and maintain its Distribution System and its Interconnection Facilities in accordance with this Agreement and Good Utility Practice.
- 2.4. The Parties agree to cause their facilities or systems to be constructed in accordance with the laws of the State of Minnesota and to meet or exceed applicable codes and standards provided by the National Electrical Safety Code, the American National Standards Institute, Institute of Electrical and Electronics Engineers (IEEE), Underwriter's Laboratory (UL), Minnesota Technical Requirements, Operating Requirements, and local building codes and other applicable ordinances in effect at the time of construction. The Interconnection Customer agrees to design, install, maintain, and operate its Distributed Energy Resource so as to reasonably minimize the

likelihood of a disturbance adversely affecting or impairing the system or equipment of the Area EPS Operator and any Affected Systems.

- 2.5. Each Party shall operate, maintain, repair, and inspect, and shall be fully responsible for the facilities that it now owns or subsequently owns unless otherwise specified in the Attachments to this Agreement. Each Party shall be responsible for the safe installation, maintenance, repair and condition of their respective lines and appurtenances on their respective sides of the point of common coupling. The Area EPS Operator and the Interconnection Customer, as appropriate, shall provide Interconnection Facilities that adequately protect the Area EPS Operator's Distribution System, personnel, and other persons from damage and injury. The allocation of responsibility for the design, installation, operation, maintenance and ownership of Interconnection Facilities shall be delineated in the Attachments to this Agreement.
- 2.6. The Area EPS Operator shall coordinate with all Affected Systems to support the interconnection.

3 Parallel Operation Obligations

- 3.1. Once the Distributed Energy Resource has been authorized to commence parallel operation, the Interconnection Customer shall abide by all rules and procedures pertaining to the parallel operation of the Distributed Energy Resource in the applicable control area, including, but not limited to: 1) the rules and procedures concerning the operation of generation set forth by the applicable system operator(s) for the Area EPS Operator's Distribution System provided or referenced in an attachment to this Agreement and; 2) the Operating Requirements set forth in Attachment 5 of this Agreement.

4 Metering

- 4.1. As described in MIP Process Overview Section 9.1, the Interconnection Customer shall be responsible for the Area EPS Operator's reasonable and necessary cost for the purchase, installation, operation, maintenance, testing, repair, and replacement of metering and data acquisition equipment specified in Attachments 2 and 3 of this Agreement. The Interconnection Customer's metering (and data acquisition, as required) equipment shall conform to applicable industry rules and Operating Requirements.

5 Distributed Energy Resource Capabilities and Grid Reliability

- 5.1. The Minnesota Technical Requirements outlines the Parties' responsibilities consistent with IEEE 1547 Standard for Interconnection and Interoperability of Distributed Energy

Resources with Associated Electric Power Systems Interfaces which provides requirements relevant to the interconnection and interoperability performance, operation and testing, and, to safety, maintenance and security considerations.

- 5.2. The Area EPS Operator may offer the Interconnection Customer the option to utilize required DER capabilities to mitigate Interconnection Customer costs related to Upgrades or Interconnection Facilities to address anticipated system impacts from the engineering review (i.e. Initial Review, Supplemental Review, or Study Process described in the MIP).

6 Equipment Testing and Inspection

- 6.1. As described in MIP Process Overview Section 9.2, the Interconnection Customer shall test and inspect its Distributed Energy Resource and Interconnection Facilities prior to interconnection pursuant to Minnesota Technical Requirements and this Agreement.

7 Authorization Required Prior to Parallel Operation

- 7.1. As described in MIP Process Overview Section 9.4, the Area EPS Operator shall use Reasonable Efforts to list applicable parallel operation requirements by providing the Minnesota Technical Requirements with the notice of approval of the Interconnection Application or by providing a website link to the document. Additionally, the Area EPS Operator shall notify the Interconnection Customer of any changes to these requirements as soon as they are known. Pursuant to the MIP Process Overview Section 9.5, the Interconnection Customer shall not operate its Distributed Energy Resource in parallel with the Area EPS Operator's Distribution System without prior written authorization of the Area EPS Operator.

8 Right of Access

- 8.1. Upon reasonable notice, the Area EPS Operator may send a qualified person to the premises of the Interconnection Customer at or immediately before the time the Distributed Energy Resource first produces energy to inspect the interconnection, and observe the commissioning of the Distributed Energy Resource (including any required testing), startup, and operation for a period of up to three (3) Business Days after initial start-up of the unit. In addition, the Interconnection Customer shall notify the Area EPS Operator at least five (5) Business Days prior to conducting any on-site verification testing of the Distributed Energy Resource.
- 8.2. Following the initial inspection process described above, at reasonable hours, and upon reasonable notice, or at any time without notice in the event of an emergency or hazardous condition, the Area EPS Operator shall have access to the Interconnection

Customer's premises for any reasonable purpose in connection with the performance of the obligations imposed on it by this Agreement or if necessary to meet its legal obligation to provide service to its customers.

- 8.3. Each Party shall be responsible for its costs associated with the interconnection of the DER system as outlined in MIP Process Overview Section 9.3 and the Minnesota Technical Requirements.

9 Term and Termination

- 9.1. This Agreement shall become effective as of the date when both the Interconnection Customer and the Area EPS Operator have both signed this Agreement. The Agreement shall continue in full force and effect until the earliest date that one of the following events occurs:
 - 9.1.1. The Parties agree in writing to terminate the Agreement;
 - 9.1.2. The Interconnection Customer may terminate this Agreement at any time by giving the Area EPS Operator twenty (20) Business Days written notice;
 - 9.1.3. The Area EPS Operator may terminate this Agreement if the Distributed Energy Resource is not interconnected to the Area EPS Operator's Distribution System within thirty-six (36) months of the effective date of this Agreement as set forth above in Section 9.1;
 - 9.1.4. Either Party may terminate this Agreement after default pursuant to Section 19.
- 9.2. No termination shall become effective until the Parties have complied with all Applicable Laws and Regulations applicable to such termination.
- 9.3. Upon termination of this Agreement, the Distributed Energy Resource will be disconnected from the Area EPS Operator's Distribution System. All costs required to effectuate such disconnection shall be borne by the terminating Party, unless such termination resulted from the non-terminating Party's default of this Agreement or such non-terminating Party otherwise is responsible for these costs under this Agreement.
- 9.4. The termination of this Agreement shall not relieve either Party of its liabilities and obligations, owed or continuing, at the time of the termination.

- 9.5. The provisions of this Section 9 shall survive termination or expiration of this Agreement.

10 Disconnection

- 10.1. Disconnection of Unit. The Area EPS Operator may disconnect the Distributed Energy Resource as reasonably necessary, including for the following conditions or situations: termination of this Agreement, non-compliance with this Agreement, a system emergency, imminent danger to the public or Area EPS personnel, or for routine maintenance, repairs, and modifications to the Area EPS. The Area EPS Operator shall use Reasonable Efforts to notify the Interconnection Customer promptly when it becomes aware of an event or condition that may reasonably be expected to affect the Interconnection Customer's operation of the Distributed Energy Resource. The Interconnection Customer shall use Reasonable Efforts to notify the Area EPS Operator promptly when it becomes aware of an event or condition that may reasonably be expected to affect the Area EPS Operator's Distribution System or any Affected Systems. To the extent information is known, the notification shall describe the event or condition, the extent of the damage or deficiency, the expected effect on the operation of both Parties' facilities and operations, its anticipated duration, and the necessary corrective action. It is agreed that the Area EPS Operator shall have no liability for any loss of sales or other damages including all consequential damages for the loss of business opportunity, profits or other losses, regardless of whether such damages were foreseeable, due to the disconnection of the Distributed Energy Resource.
- 10.2. Temporary Interruption. The Area EPS Operator may interrupt interconnection service or curtail the output of the Distributed Energy Resource and temporarily disconnect the Distributed Energy Resource from the Area EPS Operator's Distribution System when necessary for routine maintenance, construction, or repairs on the Area EPS Operator's Distribution System. The Area EPS Operator shall use Reasonable Efforts to provide the Interconnection Customer with three (3) Business Days' notice prior to such interruption. The Area EPS Operator shall use Reasonable Efforts to coordinate such reduction or temporary disconnection with the Interconnection Customer. Temporary disconnection shall continue only for so long as reasonably necessary under Good Utility Practice.
- 10.3. Forced Outage. During any forced outage, the Area EPS Operator may suspend interconnection service to effect immediate repairs on the Area EPS Operator's Distribution System. The Area EPS Operator shall use Reasonable Efforts to provide the Interconnection Customer with prior notice. If prior notice is not reasonably possible, the Area EPS Operator shall, upon request, provide the Interconnection Customer

written documentation after the fact explaining the circumstances of the disconnection.

- 10.4. Adverse Operating Effects. The Area EPS Operator shall notify the Interconnection Customer as soon as practicable if, based on Good Utility Practice, operation of the Distributed Energy Resource may cause disruption or deterioration of service to other customers served from the same electric system, or if operating the Distributed Energy Resource could cause damage to the Area EPS Operator's Distribution System or Affected Systems. Supporting documentation used to reach the decision to disconnect shall be provided to the Interconnection Customer upon request. If, after notice, the Interconnection Customer fails to remedy the adverse operating effect within a reasonable time, the Area EPS Operator may disconnect the Distributed Energy Resource. The Area EPS Operator shall provide the Interconnection Customer with five (5) Business Days' notice of such disconnection, unless the provisions of Section 10.1 apply.
- 10.5. Modification of the Distributed Energy Resource. The Interconnection Customer must receive written authorization from the Area EPS Operator before making any change to the Distributed Energy Resource that may have a material impact on the safety or reliability of the Distribution System. Such authorization shall not be unreasonably withheld if the modification is not a Material Modification. Material Modifications, including an increase Nameplate Rating or capacity, may require the Interconnection Customer to submit a new Interconnection Application as described in Section 7 of the MIP Process Overview. If the Interconnection Customer makes such modification without the Area EPS Operator's prior written authorization, the Area EPS Operator shall have the right to temporarily disconnect the Distributed Energy Resource.
- 10.6. Reconnection. The Parties shall cooperate with each other to restore the Distributed Energy Resource, Interconnection Facilities, and the Area EPS Operator's Distribution System to their normal operating state as soon as reasonably practicable following a temporary disconnection.
- 10.7. Treatment Similar to Other Retail Customers. If the Interconnection Customer receives retail electrical service at the same site as the Distributed Energy Resource, it may also be disconnected consistent with the rules and practices for disconnecting other retail electrical customers.
- 10.8. Disconnection for Default. If the Interconnection Customer is in default of this Agreement, it may be disconnected after a sixty (60) day written notice is provided and the default is not cured during this sixty (60) day notice. This provision does not apply to disconnection based on Sections 10.1, 10.2, 10.3 or 10.4 of this Agreement.

11 Cost Responsibility for Interconnection Facilities and Distribution Upgrades

- 11.1 Interconnection Facilities. The Interconnection Customer shall pay for the actual cost of the Interconnection Facilities itemized in Attachment 2 of this Agreement. The Area EPS Operator shall provide a good faith estimate of the cost, including overheads, for the purchase and construction of its Interconnection Facilities and provide a detailed itemization of such costs. Costs associated with Interconnection Facilities may be shared with other entities that may benefit from such facilities by agreement of the Interconnection Customer, such other entities, and the Area EPS Operator.
- 11.2 The Interconnection Customer shall be responsible for its share of all reasonable expenses, including overheads, associated with (1) owning, operating, maintaining, repairing, and replacing its own Interconnection Facilities, and (2) operating, maintaining, repairing, and replacing the Area EPS Operator's Interconnection Facilities.
- 11.3 Distribution Upgrades. The Area EPS Operator shall design, procure, construct, install, and own the Distribution Upgrades described in Attachment 7 of this Agreement. The Area EPS Operator shall provide a good faith estimate of the cost, including overheads, for the purchase and construction of the Distribution Upgrades and provide a detailed itemization of such costs. If the Area EPS Operator and the Interconnection Customer agree, the Interconnection Customer may construct Distribution Upgrades that are located on land owned by the Interconnection Customer. The actual cost of the Distribution Upgrades, including overheads, shall be directly assigned to the Interconnection Customer.

12 Cost Responsibility for Network Upgrades

- 12.1. Applicability. No portion of Section 12 shall apply unless the interconnection of the Distributed Energy Resource requires Network Upgrades.
- 12.2. Network Upgrades. The Area EPS Operator or the Transmission Owner shall design, procure, construct, install, and own the Network Upgrades described in Attachment 7 of this Agreement. The Area EPS Operator shall provide a good faith estimate of the cost, including overheads, for the purchase and construction of the Network Upgrades and provide a detailed itemization of such costs. If the Area EPS Operator and the Interconnection Customer agree, the Interconnection Customer may construct Network Upgrades that are located on land owned by the Interconnection Customer. Unless the Area EPS Operator elects to pay for Network Upgrades, the actual cost of

the Network Upgrades, including overheads, shall be borne initially by the Interconnection Customer.

- 12.3. Repayment of Amounts Advanced for Network Upgrades. The Interconnection Customer shall be entitled to a cash repayment, equal to the total amount paid to the Area EPS Operator and Affected System operator, if any, for Network Upgrades, including any tax gross-up or other tax-related payments associated with the Network Upgrades, and not otherwise refunded to the Interconnection Customer, to be paid to the Interconnection Customer on a dollar-for-dollar basis for the non-usage sensitive portion of transmission charges, as payments are made under the Area EPS Operator's Tariff and Affected System's Tariff for transmission services with respect to the Distributed Energy Resource. Any repayment shall include interest calculated in accordance with the methodology set forth in the Federal Energy Regulatory Commission's (FERC) regulations at 18 C.F.R. § 35.19a(a)(2)(iii) from the date of any payment for Network Upgrades through the date on which the Interconnection Customer receives a repayment of such payment pursuant to this subparagraph. The Interconnection Customer may assign such repayment rights to any person.
- 12.4. Notwithstanding the foregoing, the Interconnection Customer, the Area EPS Operator, and any applicable Affected System operators may adopt any alternative payment schedule that is mutually agreeable so long as the Area EPS Operator and said Affected System operators take one of the following actions no later than five years from the Commercial Operation Date: (1) return to the Interconnection Customer any amounts advanced for Network Upgrades not previously repaid, or (2) declare in writing that the Area EPS Operator or any applicable Affected System operators will continue to provide payments to the Interconnection Customer on a dollar-for-dollar basis for the non-usage sensitive portion of transmission charges, or develop an alternative schedule that is mutually agreeable and provides for the return of all amounts advanced for Network Upgrades not previously repaid; however, full reimbursement shall not extend beyond 20 years from the commercial operation date.
- 12.5. If the Distributed Energy Resource fails to achieve commercial operation, but it or another Distributed Energy Resource is later constructed and requires use of the Network Upgrades, the Area EPS Operator and Affected System operator shall at that time reimburse the Interconnection Customer for the amounts advanced for the Network Upgrades. Before any such reimbursement can occur, the Interconnection Customer, or the entity that ultimately constructs the Distributed Energy Resource, if different, is responsible for identifying the entity to which reimbursement must be made.

- 12.6. Special Provisions for Affected Systems. Unless the Area EPS Operator provides, under this Agreement, for the repayment of amounts advanced to any applicable Affected System operators for Network Upgrades, the Interconnection Customer and Affected System operator shall enter into an agreement that provides for such repayment. The agreement shall specify the terms governing payments to be made by the Interconnection Customer to Affected System operator as well as the repayment by Affected System Operator.
- 12.7. Rights Under Other Agreements. Notwithstanding any other provision of this Agreement, nothing herein shall be construed as relinquishing or foreclosing any rights, including but not limited to firm transmission rights, capacity rights, transmission congestion rights, or transmission credits, that the Interconnection Customer shall be entitled to, now or in the future, under any other agreement or tariff as a result of, or otherwise associated with, the transmission capacity, if any, created by the Network Upgrades, including the right to obtain cash reimbursements or transmission credits for transmission service that is not associated with the Distributed Energy Resource.

13 Billing, Payment, Milestones, and Financial Security

- 13.1. Billing and Payment Procedures and Final Accounting. The Area EPS Operator shall bill the Interconnection Customer for the design, engineering, construction, and procurement costs of Interconnection Facilities and Upgrades contemplated by this Agreement, and the Interconnection Customer shall pay each bill, pursuant to the MIP Interconnection Process documents, or as otherwise agreed to by the Parties.
- 13.2. Within 80 Business Days (approximately 4 calendar months) of completing the construction and installation of the Area EPS Operator's Interconnection Facilities and/or Upgrades described in the Attachments to this Agreement, the Area EPS Operator shall provide the Interconnection Customer with a final accounting report, as described in the MIP Fast Track Process Section 9.5.3 and the Study Process Section 11.4.3.
- 13.3. Milestones. Pursuant to the MIP Fast Track Process Section 9.1 and the Study Process Section 11.1, the Parties shall agree on milestones for which each Party is responsible and list them in Attachment 4 of this Agreement.
- 13.4. Financial Security Arrangements. Pursuant to the MIP Fast Track Process Section 9.6 and the Study Process Section 11.5, the Interconnection Customer shall provide the Area EPS Operator, at the Interconnection Customer's option, a guarantee, letter of credit or other form of security that is reasonably acceptable to the Area EPS Operator and is consistent with the Minnesota Uniform Commercial Code. Such security for

payment shall be in an amount sufficient to cover the costs for constructing, designing, procuring, and installing the applicable portion of the Area EPS Operator's Interconnection Facilities and Upgrades and shall be reduced on a dollar-for-dollar basis for payments made to the Area EPS Operator under this Agreement during its term. In addition:

- 13.4.1. The guarantee must be made by an entity that meets the creditworthiness requirements of the Area EPS Operator, and contain terms and conditions that guarantee payment of any amount that may be due from the Interconnection Customer, up to an agreed-to maximum amount.
- 13.4.2. The letter of credit must be issued by a financial institution or insurer reasonably acceptable to the Area EPS Operator and must specify a reasonable expiration not sooner than sixty (60) Business Days (three calendar months) after the due date for the issuance of the final bill.

14 Assignment

- 14.1. The Interconnection Customer shall not assign its rights nor delegate its duties under this Agreement without the prior written consent of the Area EPS Operator. Any assignment or delegation made by the Interconnection Customer without the Area EPS Operator's written consent shall not be valid. The Area EPS Operator shall not unreasonably withhold its consent to the Interconnection Customer's assignment or delegation under this Agreement.

15 Limitations of Liability

- 15.1. Each Party's liability to the other Party for failure to perform its obligations under this Agreement shall be limited to the amount of direct damage actually incurred. In no event shall either Party be liable to the other Party for any indirect, special, consequential, or punitive damages of any kind whatsoever, including for loss of business opportunity or profits, regardless of whether such damages were foreseen.
- 15.2. Notwithstanding any other provision in this Agreement, with respect to the Area EPS Operator's provision of electric service to any customer including the Interconnection Customer, the Area EPS Operator's liability to such customer shall be limited as set forth in the Area EPS Operator's tariffs and terms and conditions for electric service, and shall not be affected by the terms of this Agreement.

16 Non-Warranty

- 16.1. The Area EPS Operator does not give any warranty, expressed or implied, as to the adequacy, safety, or other characteristics of any structures, equipment, wires, appliances or devices owned, installed or maintained by the Interconnection Customer or leased by the Interconnection Customer from third parties, including without limitation, the Distributed Energy Resource and any structures, equipment, wires, appliances or devices not owned, operated or maintained by the Area EPS Operator.

17 Indemnity

- 17.1. This provision protects each Party from liability incurred to third parties as a result of carrying out the provisions of this Agreement. Liability under this provision is exempt from the general limitations on liability found in Section 15.
- 17.2. Each Party shall at all times indemnify, defend, and hold the other Party harmless from any and all damages, losses, claims, including claims and actions relating to injury or death of any person or damage to property, demand, suits, recoveries, costs and expenses, court costs, reasonable attorney fees, and all other obligations by or to third parties, arising out of or resulting from the Party's action or failure to meet its obligations under this Agreement, except to the extent that such damages, losses or claims were caused by the negligence or intentional acts of the other Party.
- 17.3. If an indemnified Party is entitled to indemnification under this article as a result of a claim by a third party, and the indemnifying Party fails, after notice and reasonable opportunity to proceed under this article, to assume the defense of such claim, such indemnified Party may at the expense of the indemnifying Party contest, settle or consent to the entry of any judgment with respect to, or pay in full, such claim.
- 17.4. If an indemnifying Party is obligated to indemnify and hold any indemnified Party harmless under this article, the amount owing to the indemnified Party shall be the amount of such indemnified Party's actual loss, net of any insurance or other recovery.
- 17.5. Promptly after receipt by an indemnified Party of any claim or notice of the commencement of any action, administrative or legal proceeding, or investigation as to which the indemnity provided for in this article may apply, the indemnified Party shall notify the indemnifying Party of such fact. Any failure of or delay in such notification shall not affect a Party's indemnification obligation unless such failure or delay is materially prejudicial to the indemnifying Party.

18 Force Majeure

18.1. If a Force Majeure Event prevents a Party from fulfilling any obligations under this Agreement, the Party affected by the Force Majeure Event (Affected Party) shall promptly notify the other Party, either in writing or via the telephone, of the existence of the Force Majeure Event. The notification must specify in reasonable detail the circumstances of the Force Majeure Event, its expected duration, and the steps that the Affected Party is taking to mitigate the effects of the event on its performance. The Affected Party shall keep the other Party informed on a continuing basis of developments relating to the Force Majeure Event until the event ends. The Affected Party will be entitled to suspend or modify its performance of obligations under this Agreement (other than the obligation to make payments) only to the extent that the effect of the Force Majeure Event cannot be mitigated by the use of Reasonable Efforts. The Affected Party will use Reasonable Efforts to resume its performance of obligations under this Agreement as soon as possible.

19 Default

19.1. No default of any obligation under this Agreement shall exist where such failure to discharge an obligation (other than the payment of money) is the result of a Force Majeure Event as defined in this Agreement or the result of an act or omission of the other Party. Upon a default, the non-defaulting Party shall give written notice of such default to the defaulting Party. Except as provided in Section 18, the defaulting Party shall have sixty (60) calendar days from receipt of the default notice within which to cure such default; provided however, if such default is not capable of cure within sixty (60) calendar days, the defaulting Party shall commence such cure within twenty (20) calendar days after notice and continuously and diligently complete such cure within six (6) months from receipt of the default notice; and, if cured within such time, the default specified in such notice shall cease to exist.

19.2. If a default is not cured as provided in this Section 19, or if a default is not capable of being cured within the period provided for herein, the non-defaulting Party shall have the right to terminate this Agreement by written notice at any time until cure occurs, and be relieved of any further obligation hereunder and, whether or not that Party terminates this Agreement, to recover from the defaulting Party all amounts due hereunder, plus all other damages and remedies to which it is entitled at law or in equity. The provisions of this Section 19 will survive termination of this Agreement.

20 Insurance

20.1. An Area EPS Operator may only require an Interconnection Customer to purchase insurance covering damages pursuant to the applicable MIP process document to which the Distributed Energy Resource is subject to.

- 20.2. The Area EPS Operator agrees to maintain general liability insurance or self-insurance consistent with the Area EPS Operator's commercial practice. Such insurance or self-insurance shall not exclude coverage for the Area EPS Operator's liabilities undertaken pursuant to this Agreement.
- 20.3. The Parties further agree to notify each other whenever an accident or incident occurs resulting in any injuries or damages that are included within the scope of coverage of such insurance, whether or not such coverage is sought.
- 20.4. Failure of the Interconnection Customer or Area EPS Operator to enforce the minimum levels of insurance does not relieve the Interconnection Customer from maintaining such levels of insurance or relieve the Interconnection Customer of any liability.

21 Confidential Information

- 21.1. Each Party shall treat and protect Confidential Information under this Agreement in accordance with the Confidentiality provisions in the MIP Process Overview document Section 12.1.

22 Disputes

- 22.1. The Parties agree to attempt to resolve all disputes arising hereunder promptly, equitably and in a good faith manner. The Parties agree to follow the established dispute resolution policy adopted by the Area EPS Operator.

23 Taxes

- 23.1. The Parties agree to follow all applicable tax laws and regulations, consistent with Internal Revenue Service and any other relevant local, state and federal requirements.
- 23.2. Each Party shall cooperate with the other to maintain the other Party's tax status. It is incumbent on the Party seeking to maintain its tax status to provide formal written notice to the other Party detailing what exact cooperation it is seeking from the other Party well prior to any deadlines by which any such action would need to be taken. Nothing in this Agreement is intended to adversely affect, if applicable, the Area EPS Operator's tax-exempt status with respect to the issuance of bonds including, but not limited to, local furnishing bonds.

24 Miscellaneous

- 24.1. Governing Law, Regulatory Authority, and Rules. This Agreement shall be interpreted, governed, and construed under the laws of the State of Minnesota, without regard to

its conflicts of law principles. This Agreement is subject to all Applicable Laws and Regulations. Each Party expressly reserves the right to seek changes in, appeal, or otherwise contest any laws, orders, or regulations of a Governmental Authority.

- 24.2. Amendment. The Parties may amend this Agreement by a written instrument duly executed by both Parties, or under Section 24.11 of this Agreement.
- 24.3. No Third-Party Beneficiaries. This Agreement is not intended to and does not create rights, remedies, or benefits of any character whatsoever in favor of any persons, corporations, associations, or entities other than the Parties, and the obligations herein assumed are solely for the use and benefit of the Parties, their successors in interest and where permitted, their assigns.
- 24.4. Waiver. None of the provisions of this Agreement shall be considered waived by a Party unless such waiver is given in writing. The failure of a Party to insist in any one or more instances upon strict performance of any of the provisions of this Agreement or to take advantage of any of its rights hereunder shall not be construed as a waiver of any such provisions or the relinquishment of any such rights for the future, but the same shall continue and remain in full force and effect.
- 24.5. Entire Agreement. This Agreement, including all attachments, constitutes the entire agreement between the Parties with regard to the interconnection of the Distributed Energy Resource of the Parties at the Point(s) of Common Coupling expressly provided for in this Agreement and supersedes all prior agreements or understandings, whether verbal or written. It is expressly acknowledged that the Parties may have other agreements covering other services not expressly provided for herein, which agreements are unaffected by this Agreement. Each Party also represents that in entering into this Agreement, it has not relied on the promise, inducement, representation, warranty, agreement, or other statement not set forth in this Agreement or in the incorporated attachments.
- 24.6. Multiple Counterparts. This Agreement may be executed in two or more counterparts, each of which is deemed an original but all constitute one and the same instrument.
- 24.7. No Partnership. This Agreement shall not be interpreted or construed to create an association, joint venture, agency relationship, or partnership between the Parties, or to impose any partnership obligation or partnership liability upon either Party. Neither Party shall have any right, power or authority to enter into any agreement or undertaking for, or act on behalf of, or to act as or be an agent or representative of, or to otherwise bind, the other Party.

- 24.8. Severability. If any provision or portion of this Agreement shall for any reason be held or adjudged to be invalid or illegal or unenforceable by any court of competent jurisdiction or other Governmental Authority, (1) such portion or provision shall be deemed separate and independent, (2) the Parties shall negotiate in good faith to restore insofar as practicable the benefits to each Party that were affected by such ruling, and (3) the remainder of this Agreement shall remain in full force and effect.
- 24.9. Environmental Releases. Each Party shall notify the other Party, first orally and then in writing, of the release of any hazardous substances, any asbestos or lead abatement activities, or any type of remediation activities related to the Distributed Energy Resource or the Interconnection Facilities, each of which may reasonably be expected to affect the other Party. The notifying Party shall (1) provide the notice as soon as practicable, provided such Party makes a good faith effort to provide the notice no later than 24 hours after such Party becomes aware of the occurrence, and (2) promptly furnish to the other Party copies of any publicly available reports filed with any governmental authorities addressing such events.
- 24.10. Subcontractors. Nothing in this Agreement shall prevent a Party from utilizing the services of any subcontractor as it deems appropriate to perform its obligations under this Agreement. Each Party shall require its subcontractors to comply with all applicable terms and conditions of this Agreement in providing such services and each Party shall remain primarily liable to the other Party for the performance of such subcontractor.
- 24.10.1. The creation of any subcontract relationship shall not relieve the hiring Party of any of its obligations under this Agreement. The hiring Party shall be fully responsible to the other Party for the acts or omissions of any subcontractor the hiring Party hires as if no subcontract had been made. In no event shall the Area EPS Operator be liable for the actions or inactions of the Interconnection Customer or its subcontractors with respect to obligations of the Interconnection Customer under this Agreement. Any applicable obligation imposed by this Agreement upon the hiring Party shall be equally binding upon, and shall be construed as having application to, any subcontractor of such Party.
- 24.10.2. The obligations under this Section 24 will not be limited in any way by any limitation of subcontractor's insurance.
- 24.11. Inclusion of Area EPS Operator Tariff and Rules. The interconnection services provided under this Agreement shall at all times be subject to the terms and conditions set forth in the rate schedules and rules applicable to the electric service provided by the Area

EPS Operator, which rate schedules and rules are hereby incorporated into this Agreement by this reference. Notwithstanding any other provisions of this Agreement, the Area EPS Operator shall have the right to unilaterally change its rates, charges, classification, service, tariff, or rule, or any agreement relating thereto subject to standard municipal procedures as determined by the appropriate governing board.

25 Notices

25.1. General. Unless otherwise provided in this Agreement, any written notice, demand, or request required or authorized in connection with this Agreement (“Notice”) shall be deemed properly given if delivered in person or sent by United States Mail, first class, postage prepaid, to the person specified as follows:

Area EPS Operator Information

Area EPS Operator: _____
Attention: _____
Address: _____

Phone: _____
Email: _____

Interconnection Customer Information

Interconnection Customer: _____
Attention: _____
Address: _____

Phone: _____
Email: _____

25.2. Billing and Payment. Billing and payments shall be sent to the addresses set out below:

Area EPS Operator Information

Area EPS Operator: _____
Attention: _____
Address: _____

Phone: _____
Email: _____

Interconnection Customer Information

Interconnection Customer: _____
Attention: _____
Address: _____

Phone: _____
Email: _____

25.3. Alternative Forms of Notice. Any notice or request required or permitted to be given by either Party to the other and not required by this Agreement to be given in writing may be so given by telephone or email to the telephone numbers and e-mail addresses set out below:

Area EPS Operator Information

Area EPS Operator: _____
Attention: _____
Address: _____

Phone: _____
Email: _____

Interconnection Customer Information

Interconnection Customer: _____
Attention: _____
Address: _____

Phone: _____
Email: _____

25.4. Designated Operating Representative. The Parties may also designate operating representatives to conduct the communications which may be necessary or convenient for the administration of this Agreement. This person will also serve as the point of contact with respect to operations and maintenance of the Party’s facilities.

Area EPS Operator Information

Area EPS Operator: _____
Attention: _____
Address: _____

Phone: _____
Email: _____

Interconnection Customer Information

Interconnection Customer: _____
Attention: _____
Address: _____

Phone: _____
Email: _____

25.5. Changes to Notification. Either Party may change this information by giving five Business Days written notice to the other Party prior to the effective date of the change.

26 Signatures

IN WITNESS THEREOF, the Parties have caused this Agreement to be duly executed by their duly authorized officers or agents on the day and year first above written.

[Insert name of Area EPS Operator]

[Insert name of Interconnection Customer]

Signed: _____

Signed: _____

Name (Printed):

Name (Printed):

Title: _____

Title: _____

Attachment I: Glossary of Terms

Affected System – Another Area EPS Operator’s System, Transmission Owner’s Transmission System, or Transmission System connected generation which may be affected by the proposed interconnection.

Applicant Agent – A person designated in writing by the Interconnection Customer to represent or provide information to the Area EPS on the Interconnection Customer’s behalf throughout the interconnection process.

Area EPS – The electric power distribution system connected at the Point of Common Coupling.

Area EPS Operator – An entity that owns, controls, or operates the electric power distribution systems that are used for the provision of electric service in Minnesota. For this Interconnection Process the Area EPS Operator is [NAME OF UTILITY]

Business Day – Monday through Friday, excluding Holidays as defined by Minn. Stat. §645.44, Subdivision 5. Any communication to have been sent or received after 4:30 p.m. Central Prevailing Time or on a Saturday, Sunday or holiday shall be considered to have been sent on the next Business Day.

Certified Equipment – Certified equipment is equipment that has been tested by a national recognized lab meeting a specific standard. For DER systems, UL 1741 listing is a common form of DER inverter certification. Additional information is seen in the Certification Codes and Standards document.

Confidential Information – Any confidential and/or proprietary information provided by one Party to the other Party and is clearly marked or otherwise designated “Confidential.” All procedures, design, operating specifications, and metering data provided by the Interconnection Customer may be deemed Confidential Information. See MIP Process Overview Section 12.1 for further information.

Distributed Energy Resource (DER) – A source of electric power that is not directly connected to a bulk power system or central station service. DER includes both generators and energy storage technologies capable of exporting active power to an EPS. An interconnection system or a supplemental DER device that is necessary for compliance with this standard is part of a DER. For the purpose of the Interconnection Process and interconnection agreements, the DER includes the Customer’s Interconnection Facilities but shall not include the Area EPS Operator’s Interconnection Facilities.

Distribution System – The Area EPS facilities which are not part of the Local EPS, Transmission System or any generation system.

Distribution Upgrades – The additions, modifications, and upgrades to the Distribution System at or beyond the Point of Common Coupling to facilitate interconnection of the DER and render

the distribution service necessary to affect the Interconnection Customer's connection to the Distribution System. Distribution Upgrades do not include Interconnection Facilities.

Electric Power System (EPS) – The facilities that deliver electric power to a load.

Fast Track Process – The procedure as described in the Interconnection Process - Fast Track Process for evaluating an Interconnection Application for a DER that meets the eligibility requirements in the MIP Process Overview Section 3.4.

Force Majeure Event – An act of God, labor disturbance, act of the public enemy, war, insurrection, riot, fire, storm or flood, explosion, breakage or accident to machinery or equipment, an order, regulation or restriction imposed by governmental, military or lawfully established civilian authorities, or another cause beyond a Party's control. A Force Majeure Event does not include an act of negligence or intentional wrongdoing.

Good Utility Practice – Any of the practices, methods and acts engaged in or approved by a significant portion of the electric industry during the relevant time period, or any of the practices, methods and act which, in the exercise of reasonable judgment in light of the facts known at the time the decision was made, could have been expected to accomplish the desired result at a reasonable cost consistent with good business practices, reliability, safety and expedition. Good Utility Practice is not intended to be limited to the optimum practice, method, or act to the exclusion of all others, but rather to be acceptable practices, methods, or acts generally accepted in the region.

Governmental Authority – Any federal, state, local or other governmental regulatory or administrative agency, court, commission, department, board, or other governmental subdivision, legislature, rulemaking board, tribunal, or other governmental authority having jurisdiction over the Parties, their respective facilities, or the respective services they provide, and exercising or entitled to exercise any administrative, executive, police, or taxing authority or power; provided, however, that such term does not include the Interconnection Customer, the Area EPS Operator, or any Affiliate thereof. The utility's local governing body is the authority governing interconnection requirements unless otherwise provided for in the Minnesota Technical Requirements.

Interconnection Agreement – The terms and conditions between the Area EPS Operator and Interconnection Customer (Parties). See Section 8 in the MIP Process Overview for when the MN Standard Agreement or MN Interconnection Agreement applies.

Interconnection Application – The Interconnection Customer's request to interconnect a new or modified, as described in Section 4 of the MIP Process Overview, DER. See Simplified Application Form and Interconnection Application Form.

Interconnection Customer – The person or entity, including the Area EPS Operator, whom will be the owner of the DER that proposes to interconnect a DER(s) with the Area EPS Operator's

Distribution System. The Interconnection Customer is responsible for ensuring the DER(s) is designed, operated and maintained in compliance with the Minnesota Technical Requirements.

Interconnection Facilities – The Area EPS Operator’s Interconnection Facilities and the Interconnection Customer’s Interconnection Facilities. Collectively, Interconnection Facilities include all facilities and equipment between the DER and the Point of Common Coupling, including any modification, additions or upgrades that are necessary to physically and electrically interconnect the DER to the Area EPS Operator’s System. Some examples of Customer Interconnection Facilities include: supplemental DER devices, inverters, and associated wiring and cables up to the Point of DER Connection. Some examples of Area EPS Operator Interconnection Facilities include sole use facilities; such as, line extensions, controls, relays, switches, breakers, transformers and shall not include Distribution Upgrades or Network Upgrades.

Interconnection Process – The Area EPS Operator’s interconnection standards as part of the DG Workbook - MN.

Material Modification – A modification to machine data, equipment configuration or to the interconnection site of the DER at any time after receiving notification by the Area EPS Operator of a complete Interconnection Application that has a material impact on the cost, timing, or design of any Interconnection Facilities or Upgrades, or a material impact on the cost, timing or design of any Interconnection Application with a later Queue Position or the safety or reliability of the Area EPS.¹

Minnesota Technical Requirements – This term refers to the Technical Specifications Manual adopted by the Area EPS Operator (Chapter 8 of the DG Workbook – MN) and the Minnesota Technical Interconnection and Interoperability Requirements approved by the Minnesota Public Utilities Commission in Docket No. E-999/CI-16-521.

Nameplate Rating - nominal voltage (V), current (A), maximum active power (kWac), apparent power (kVA), and reactive power (kVar) at which a DER is capable of sustained operation. For a

¹ A Material Modification shall include, but may not be limited to, a modification from the approved Interconnection Application that: (1) changes the physical location of the point of common coupling; such that it is likely to have an impact on technical review; (2) increases the nameplate rating or output characteristics of the Distributed Energy Resource; (3) changes or replaces generating equipment, such as generator(s), inverter(s), transformers, relaying, controls, etc., and substitutes equipment that is not like-kind substitution in certification, size, ratings, impedances, efficiencies or capabilities of the equipment; (4) changes transformer connection(s) or grounding; and/or (5) changes to a certified inverter with different specifications or different inverter control settings or configuration. A Material Modification shall not include a modification from the approved Interconnection Application that: (1) changes the ownership of a Distributed Energy Resource; (2) changes the address of the Distributed Energy Resource, so long as the physical point of common coupling remains the same; (3) changes or replaces generating equipment such as generator(s), inverter(s), solar panel(s), transformers, relaying, controls, etc. and substitutes equipment that is a like-kind substitution in certification, size, ratings, impedances, efficiencies or capabilities of the equipment; and/or (4) increases the DC/AC ratio but does not increase the maximum AC output capability of the Distributed Energy Resource in a way that is likely to have an impact on technical review.

Local EPS with multiple DER units, the aggregate nameplate rating is equal to the sum of all DERs nameplate rating in the Local EPS. For purposes of Attachment V to the Interconnection Agreement, the DER system’s capacity may, with the Area EPS’s agreement, be limited through use of control systems, power relays or similar device settings or adjustments as identified in IEEE 1547. The nameplate ratings referenced in the Interconnection Process are alternating current nameplate DER ratings at the Point of DER Coupling.

Network Upgrades – Additions, modifications, and upgrades to the Transmission System required at or beyond the point at which the DER interconnects with the Area EPS Operator’s System to accommodate the interconnection with the DER to the Area EPS Operator’s System. Network Upgrades do not include Distribution Upgrades.

Operating Requirements – Any operating and technical requirements that may be applicable due to the Transmission Provider’s technical requirements or Minnesota Technical Requirements, including those set forth in the Interconnection Agreement.

Party or Parties – The Area EPS Operator and the Interconnection Customer.

Point of Common Coupling (PCC) – The point where the Interconnection Facilities connect with the Area EPS Operator’s Distribution System. See figure 1. Equivalent, in most cases, to “service point” as specified by the Area EPS Operator and described in the National Electrical Code and the National Electrical Safety Code.

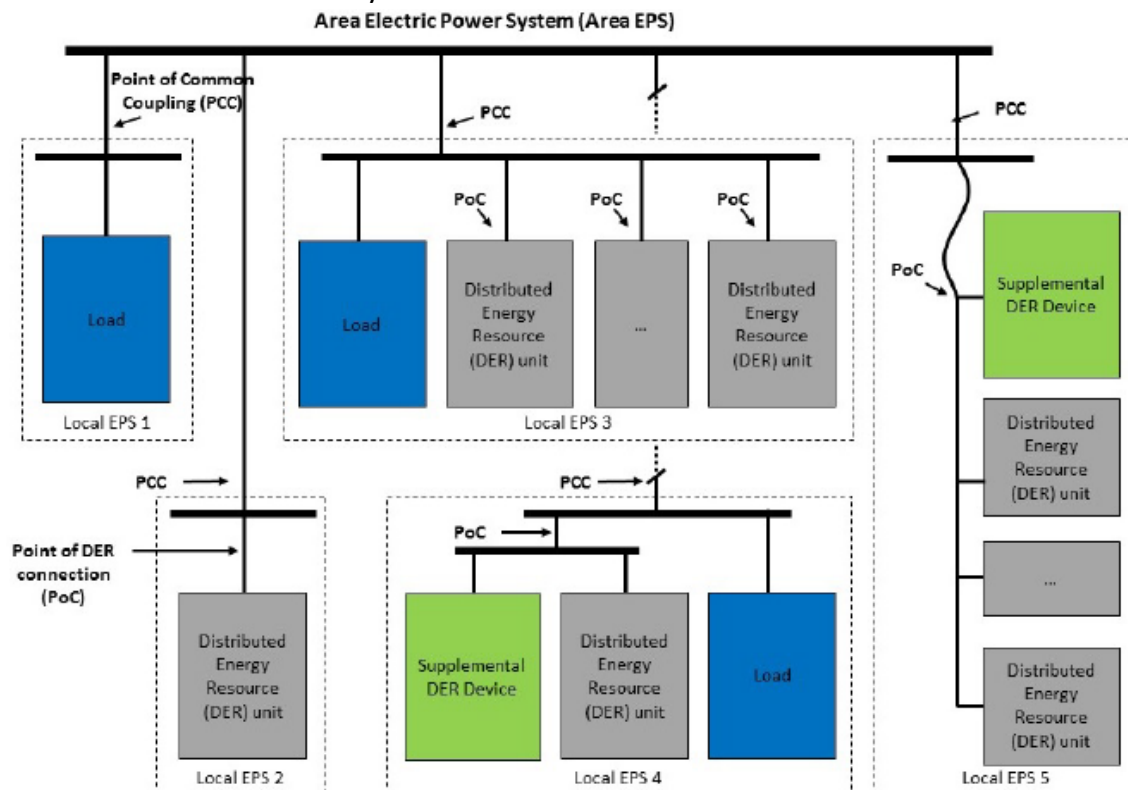

Figure 1: Point of Common Coupling and Point of DER Connection
(Source: IEEE 1547)

Point of DER Connection (PoC) – When identified as the Reference Point of Applicability, the point where an individual DER is electrically connected in a Local EPS and meets the requirements of this standard exclusive of any load present in the respective part of the Local EPS (e.g. terminals of the inverter when no supplemental DER device is required.) For DER unit(s) that are not self-sufficient to meet the requirements without a supplemental DER device(s), the Point of DER Connection is the point where the requirements of this standard are met by DER in conjunction with a supplemental DER device(s) exclusive of any load present in the respective part of the Local EPS.

Queue Position – The order of a valid Interconnection Application, relative to all other pending valid Interconnection Applications, that is established based upon the date- and time- of receipt of the complete Interconnection Application as described in Section 4.7 of the MIP Process Overview.

Reasonable Efforts – With respect to an action required to be attempted or taken by a Party under these procedures, efforts that are timely and consistent with Good Utility Practice and are otherwise substantially equivalent to those a Party would use to protect its own interests.

Reference Point of Applicability – The location, either the Point of Common Coupling or the Point of DER Connection, where the interconnection and interoperability performance requirements specified in IEEE 1547 apply. With mutual agreement, the Area EPS Operator and Customer may determine a point between the Point of Common Coupling and Point of DER Connection. See Minnesota Technical Requirements for more information.

Simplified Process – The procedure for evaluating an Interconnection Application for a certified inverter-based DER no larger than 20 kW that uses the screens described in the Interconnection Process – Simplified Process document. The Simplified Process includes simplified procedures.

Study Process – The procedure for evaluating an Interconnection Application that includes the scoping meeting, system impact study, and facilities study.

Transmission Owner – The entity that owns, leases or otherwise possesses an interest in the portion of the Transmission System relevant to the Interconnection.

Transmission Provider – The entity (or its designated agent) that owns, leases, controls, or operates transmission facilities used for the transmission of electricity. The term Transmission Provider includes the Transmission Owner when the Transmission Owner is separate from the Transmission Provider. The Transmission Provider may include the Independent System Operator or Regional Transmission Operator.

Transmission System – The facilities owned, leased, controlled or operated by the Transmission Provider or the Transmission Owner that are used to provide transmission service. See the Minnesota Public Utilities Commission’s July 26, 2000 Order Adopting Boundary Guidelines for Distinguishing Transmission from Generation and Distribution Assets in Docket No. E-999/CI-99-1261.

MN Standard Agreement – the Area EPS Operator’s Interconnection and Power Purchase Agreement that may be applied to all qualifying new and existing interconnections between the Area EPS Operator and an DER system having capacity of 100 kW or less.

Upgrades – The required additions and modifications to the Area EPS Operator’s Transmission or Distribution System at or beyond the Point of Interconnection. Upgrades may be Network Upgrades or Distribution Upgrades. Upgrades do not include Interconnection Facilities.

Attachment II: Description and Costs of the Distributed Energy Resource, Interconnection Facilities, and Metering Equipment

Equipment, including the Distribution Energy Resource, Interconnection Facilities, and metering equipment shall be itemized and identified as being owned by the Interconnection Customer or the Area EPS Operator. The Area EPS Operator will provide a good faith estimate itemized cost, including administrative overheads, of its Interconnection Facilities and metering equipment, and a good faith estimate itemized cost of the annual operation and maintenance expenses associated with the Interconnection Facilities and metering equipment.

Attachment III: One-line Diagram Depicting the Distributed Energy Resource, Interconnection Facilities, and Metering Equipment, and Upgrades

Attach the one-line diagram of the Distributed Energy Resource, Interconnection Facilities, Metering Equipment, and Upgrades to which this Agreement applies.

Attachment IV: Milestones

The Milestones in line (1) below may be a calendar date. All other dates in this Attachment IV may be the number of Business Days from the calendar date in line (1) or from the completion of a different Milestone described in a specific number line. Similarly, the anticipated In-Service Date may be based on the number of Business Days from the completion of a specified line number.

In-Service Date: _____

Critical milestones and responsibilities as agreed to by the Parties:

	Milestone/Anticipated Date	Responsible Party
(1)	_____	_____
(2)	_____	_____
(3)	_____	_____
(4)	_____	_____
(5)	_____	_____
(6)	_____	_____
(7)	_____	_____
(8)	_____	_____
(9)	_____	_____
(10)	_____	_____
(11)	_____	_____
(12)	_____	_____
(13)	_____	_____

Agreed to by:

Area EPS Operator _____ Date _____

Transmission Owner
(If Applicable) _____ Date _____

Interconnection
Customer _____ Date _____

Attachment V: Operating Agreement

The Area EPS Operator shall also provide requirements that must be met by the Interconnection Customer prior to initiating parallel operation with the Area EPS Operator's Distribution System. Each Distributed Energy Resource interconnection will be unique and will require a unique Operating Agreement. The following is a listing of some of the possible areas that will be covered in an operating agreement. The following has not been developed into a standard agreement due to the unique nature of each Distributed Energy Resource. It is envisioned that this Attachment will be tailored by the Area EPS Operator for each Distributed Energy Resource interconnection. It is also intended that this Operating Agreement Attachment will be reviewed and updated periodically to allow the operation of the Distributed Energy Resource to change to meet the needs of both the Area EPS Operator and the Interconnection Customer. There may also be operating changes required by outside parties or influences, such as changes in FERC and regional transmission organization requirements and/or policy changes which will require this Operating Agreement to be modified.

The following items are provided to show the general types of items that may be included in this Operating Agreement. The list of items is not all-inclusive and is not meant to preclude any other issues that may be addressed in the Operating Agreement.

- A. Applicable Area EPS Tariffs – Identify which tariffs are being applied for and how the tariffs would be applicable to this installation.
- B. Var Requirements – Sufficient power factor correction and control devices shall be furnished on the Distributed Energy Resource system such that a 98% power factor, minimum, is maintained across the point of interconnection at all times. Sufficient power factor correction and control devices shall be furnished on the Distributed Energy Resource system to provide the capability of unity power factor across the point of interconnection when operating at full generation output capacity. The Distributed Energy Resource shall be set up to attempt to maintain unity power factor at all times during operation.
- C. Metering Arrangement
 - 1. The project will be adequately metered, with metering that is approved by the Area EPS Operator. The meter will be a bi-directional meter capable of metering the energy and power coming from the Distributed Energy Resource or capable of being furnished to the generator. The project and the Interconnection Customer will comply with the standards set out in the MN Interconnection Process.
 - 2. The Area EPS Operator shall provide Missouri River Energy Services (MRES) metering data for inadvertent energy received by the Area EPS on the Area EPS Operator's monthly billing cycle. The metering data shall be made available to MRES no later than

ten days after the end of the monthly billing cycle. The Area EPS Operator shall test the metering equipment on a scheduled basis. If the metering equipment fails to register proper amounts or the registration thereof becomes so erratic as to be meaningless, the inadvertent energy shall be determined by the Area EPS Operator from the best information available.

- D. Inadvertent Energy – MRES shall purchase all inadvertent energy supplied by the Distributed Energy Resource which is received by the Area EPS. The rate paid by MRES for the inadvertent energy will be equal to the commensurate real-time hourly locational marginal price (LMP) as settled by the Midcontinent Independent System Operator (MISO) or Southwest Power Pool (SPP) for the commercial pricing node [*identify node*] located at or near to [*name of local utility*], for the hours during which inadvertent energy was received by the Area EPS, less any administrative costs charged by MISO, SPP or other utilities with respect to the sale or transfer of such energy. The Interconnection Customer acknowledges and agrees that the hourly LMP rate fluctuates based upon the supply and demand for energy within the MISO or SPP market as determined by MISO or SPP, and that it is possible that the LMP price at times may be negative, meaning that the Interconnection Customer may have to make (rather than receive) payment for inadvertent energy received by the Area EPS. The Interconnection Customer shall receive payment for the inadvertent energy to MRES through a credit on the Interconnection Customer's monthly invoice from the Area EPS Operator. MRES, in turn, shall credit the monthly wholesale power supply bill submitted by MRES to the Area EPS Operator in an amount equal to the purchases of inadvertent energy during the preceding month. The Area EPS Operator shall provide to MRES, as soon as available following the end of each month, data indicating the amount of inadvertent energy purchased by MRES from the Interconnection Customer's generation during the preceding month.
- E. Control Issues – Starting and stopping of the generation, including the remote starting and stopping, if applicable.
- F. Dispatch of Distributed Energy Resources – What are the dispatch requirements for the Distributed Energy Resource; can it only run during Peak Hours? Are there a limited number of hours that it can run? Is it required to meet an availability percentage? The answer to these questions will depend greatly upon the PPA and other requirements. Is the Interconnection Customer required to coordinate outages of the Distributed Energy Resource with the Area EPS? Prior to any planned outage and following an unplanned outage, the Area EPS and MRES shall be notified in a timely manner.
- G. Outages of Distribution System – How are emergency outages handled? How are other outages scheduled? If the Interconnection Customer requires the Area EPS Operator to schedule the outages during after-hours, who pays for the Area EPS Operator's overtime?

- H. Notification/Contacts – Who should be notified? How should they be notified? When should they be notified? For what reasons should the notification take place?
1. Starting of the generation
 2. Dispatching of generation
 3. Notification of failures (both Area EPS and Distributed Energy Resource failures)
- I. Documentation of Operational Settings – How much fuel will the generation system typically have on hand? How long can it run with this fuel capacity? How is the generation system set to operate for a power failure? These may be issues documented in the Operating Agreement. The following are examples of what may be documented:
1. The Distributed Energy Resource will monitor the Area EPS phase voltage and after 2 seconds of any phase voltage below 90%, the generation will be started and the load transferred to the generator, if the generation is not already running.
 2. The Distributed Energy Resource will wait for 30 minutes after it senses the return of the Area EPS frequency and voltage before it will automatically reconnect to the Area EPS.
- J. Cost of Testing for Future Failures – If a failure of a component of the Distributed Energy Resource affects the interconnection with the Area EPS, what is the process for retesting, and for replacement? Who pays for the additional costs of the Area EPS to work with the Interconnection Customer to resolve these problems and/or to complete retesting of the modified equipment?
- K. Right of Access – At all times, the Area EPS Operator shall have access to the disconnect switch of the Distributed Energy Resource for any reasonable purpose in connection with the performance of the obligations imposed on it by this Agreement, to meet its obligation to operate the Area EPS safely, and to provide service to its customers. If necessary for the purpose of this Agreement, the Interconnection Customer shall allow the Area EPS Operator access to the Area EPS's equipment and facilities located on the premises.
- L. Power Quality – The installation shall be constructed and operated to ensure that the Area EPS Operator's Distribution System is not adversely affected by power quality issues which may be caused by the Distributed Energy Resource, including voltage flicker. The Distributed Energy Resource shall be equipped with devices which serve to minimize power quality disturbances, including soft starting controls to minimize inrush currents and control devices to prevent multiple units from starting simultaneously.

SIGNATURES

IN WITNESS WHEREOF, the Parties hereto have caused three originals of this Agreement to be executed by their duly authorized representatives. This Agreement is effective as of the last date set forth below.

Interconnection Customer

By: _____

Name: _____

Title: _____

Date: _____

Area EPS Operator

By: _____

Name: _____

Title: _____

Date: _____

Missouri River Energy Services

By: _____

Name: _____

Title: _____

Date: _____

Attachment VI: Maintenance Agreement

Each Distributed Energy Resource interconnection will be unique and will require a unique Maintenance Agreement. This Maintenance Agreement will be tailored for each Distributed Energy Resource interconnection. It is also intended that this Maintenance Agreement will be reviewed and updated periodically to allow changes to meet the needs of both the Area EPS Operator and the Interconnection Customer (provided the change does not negatively affect the other Party). There may also be changes required by outside parties and influences such as changes in FERC or MISO/SPP requirements and/or policies which will require this Agreement to be modified.

- A. Routine Maintenance Requirements
 - 1. Who is providing maintenance – Contact information
 - 2. Periods of maintenance

- B. Modifications to the Distributed Energy Resource – The Interconnection Customer shall notify the Area EPS Operator, in writing, of plans for any modifications to the Distributed Energy Resource interconnection equipment at least twenty (20) business days prior to undertaking such modification. Modifications to any of the interconnection equipment, including all required protective systems, the generation control systems, the transfer switches/breakers, VTs & CTs, generating capacity, and associated wiring, shall be included in the notification to the Area EPS Operator. The Interconnection Customer agrees not to commence installation of any modifications to the Distributed Energy Resource until the Area EPS Operator has approved the modification in writing. The Area EPS shall have ten (10) business days to review and respond to the modification after receipt of the information required for review of the modifications.

SIGNATURES

IN WITNESS WHEREOF, the Parties hereto have caused two originals of this Agreement to be executed by their duly authorized representatives. This Agreement is effective as of the last date set forth below.

Interconnection Customer

Area EPS Operator

By: _____

By: _____

Name: _____

Name: _____

Title: _____

Title: _____

Date: _____

Date: _____

Attachment VII: Area EPS Operator’s Description of Distribution and Network Upgrades and Good Faith Estimates of Upgrade Costs

The Area EPS Operator shall describe Distribution and Network Upgrades and provide an itemized good faith estimate of the costs, including administrative overheads, of the Upgrade and annual operations and maintenance expenses associated with such Upgrades. The Area EPS Operator shall functionalize Upgrade costs and annual expenses as either transmission or distribution related. Additional Distribution or Network Upgrades required for an Affected System may be addressed in a separate agreement as described in Section 12.6 of the MN Interconnection Agreement.

Attachment VIII: Assignment of Interconnection Agreement

This Assignment of Interconnection Agreement (“Assignment”) is made and entered into this ____ day of _____, _____, by and between _____, a municipal utility existing under the laws of the State of Minnesota (“Area EPS Operator”), _____ (“Assignor”), and _____ (“Assignee”).

WHEREAS, the Area EPS Operator and Assignor previously entered into an Interconnection Agreement (“Agreement”) dated as of _____, _____, including any and all Attachments and amendments thereto, for a Distributed Energy Resource (DER) described as follows:

DER System Information

Type of DER System: _____
Capacity Rating of System (AC): _____
Limited Capacity Rating (AC): _____
Address of DER System: _____

WHEREAS, the Assignor intends to convey its interest in the above-referenced DER to the Assignee, and the Assignor intends to assign its rights and obligations under the Agreement to the Assignee.

NOW THEREFORE, in consideration of the mutual undertakings herein contained, the Assignor, the Assignee, and the Area EPS Operator agree as follows:

- 1. Capitalized Terms.** Capitalized terms used but not defined herein shall have the meanings set forth in the Agreement.
- 2. Consent to Assignment.** The Assignor hereby irrevocably assigns the Agreement in all respects to the Assignee and the Assignee accepts the assignment thereof in all respects.
- 3. Amendment to Agreement.** The Area EPS Operator consents to this assignment and, as assigned, the Agreement is hereby amended so that wherever the name of the Assignor

is used therein it shall mean the Assignee. It is further agreed that all terms and conditions of the Agreement, as amended by this Assignment, shall remain in full force and effect.

- 4. **Payments by Area EPS Operator.** Any and all payments made by Area EPS Operator under the Agreement to either the Assignor or the Assignee shall be deemed to have been made to both and shall discharge the Area EPS Operator from any further liability with regard to said payment.

- 5. **Financial Obligations of Assignor and Assignee.** Any and all financial liability, including but not limited to amounts due, from the Interconnection Customer to the Area EPS Operator, occurring or accruing under the Agreement on or before the date of the signature of the Area EPS Operator to this Assignment shall be deemed to be the obligation of both the Assignor and Assignee, and the Area EPS Operator may recover any such amounts jointly and severally from the Assignor and Assignee.

- 6. **Contact information.** The following information updates and replaces the designated information as set forth on page 1 of the Agreement, and in Section 25.1, 25.2, 25.3 and 25.4 of the Agreement.

Page 1 Interconnection Customer Information

Interconnection Customer: _____
Attention: _____
Address: _____

Phone: _____
Email: _____

25.1 General Notices. Interconnection Customer Information

Interconnection Customer: _____
Attention: _____
Address: _____

Phone: _____
Email: _____

25.2 Billing and Payment Notices. Interconnection Customer Information

Interconnection Customer: _____
Attention: _____
Address: _____

Phone: _____
Email: _____

25.3 Alternative Forms of Notices. Interconnection Customer Information

Interconnection Customer: _____
Attention: _____
Address: _____

Phone: _____
Email: _____

25.4 Designated Operating Representative. Interconnection Customer Information

Interconnection Customer: _____
Attention: _____
Address: _____

Phone: _____
Email: _____

7. Signatures. Facsimile or electronic signatures, or signatures to this Assignment sent electronically, shall have the same effect as original signatures. Photocopies, or electronically stored versions of this Assignment, shall have the same validity as the original.

The Area EPS Operator, Assignor, and Assignee have executed this Assignment as of the dates set forth below.

Assignor

[Insert legal name of Assignor]

Signed: _____

Name (Printed): _____

Title: _____

Date: _____

Assignee

[Insert legal name of Assignee]

Signed: _____

Name (Printed): _____

Title: _____

Date: _____

Area EPS Operator

[Insert legal name of Area EPS Operator]

Signed: _____

Name (Printed): _____

Title: _____

Date: _____

INTERCONNECTION PROCESS

MN Study Process

SUMMARY

Interconnection Process for Distributed Energy Resources greater than 4 MW or requiring additional studies to be interconnected to the Distribution System of a Municipal in the State of Minnesota.

Contents

- 1 Applicability** 1
 - 1.1. Applicability 1
 - 1.2. Codes, Standards and Certification Requirements 1
- 2 Application Submission** 1
 - 2.1. Initial Interconnection Application for the MN Study Process 1
 - 2.2. Professional Licensed Engineer Signature 2
 - 2.3. Battery Storage 2
 - 2.4. Site Control..... 2
 - 2.5. Interconnection Applications from Other Processes..... 2
- 3 Initial Steps** 3
 - 3.1. Completeness Review and Queue Position 3
 - 3.2. Scoping Meeting..... 3
- 4 System Impact Study** 4
 - 4.1. Electric System Impacts..... 4
 - 4.2. MN System Impact Study Agreement..... 4
 - 4.3. System Impact Study Costs 4
 - 4.4. System Impact Study Timelines 5
- 5 Transmission System Impact Study** 5
 - 5.1. Transmission System Impacts 5
 - 5.2. MN Transmission System Impact Study Timelines 6
 - 5.3. Regional Transmission Operator Jurisdiction 6
- 6 Facilities Study** 6
 - 6.1. Construction of Facilities..... 6
 - 6.2. MN Facilities Study Agreement..... 7
 - 6.3. Facilities Study Timeline..... 7
 - 6.4. Identification of Construction of Facilities..... 7
 - 6.5. MN Facilities Study Report Timeline 8
- 7 Interconnection Agreement**..... 9
 - 7.1. MN Standard Agreement 9

7.2.	MN Interconnection Agreement.....	9
7.3.	Completion of Agreement.....	9
8	Insurance	10
8.1.	Insurance Requirements	10
8.2.	Proof of Insurance	10
9	Timeline Extensions	11
9.1.	Reasonable Efforts	11
9.2.	Extensions	11
10	Modifications to Application	11
10.1.	Procedures	11
10.2.	Timelines	12
11	Interconnection	12
11.1.	Interconnection Milestones	12
11.2.	Metering.....	13
11.3.	Inspection, Testing and Commissioning.....	13
11.4.	Interconnection Costs	14
11.5.	Security of Payment	15
11.6.	Non-Warranty	16
11.7.	Authorization for Parallel Operation.....	16
11.8.	Continual Compliance	17
11.9.	Disconnection of DER.....	17

1 Applicability

1.1. Applicability

The MN Study Process is applicable to an Interconnection Customer proposing to interconnect a Distributed Energy Resource (DER) with the Area Electrical Power System (Area EPS) Operator's Distribution System if the DER capacity is larger than 4 MW or is identified through the engineering screening process to need additional studies.

The majority of proposed DER interconnections will initially apply for interconnection under the Simplified or Fast Track Processes. Initial and supplemental screening results are to be considered throughout the MN Study Process.

1.2. Codes, Standards and Certification Requirements

The Interconnection Customer's proposed DER must meet the codes, standards and certification requirements listed in Section 14 of the MN Interconnection Process Overview document (Chapter 8 of the DG Workbook – MN) and the Minnesota Technical Requirements. The Area EPS Operator may allow DER systems that do not meet codes, standards and certification only if the DER system design is reviewed, tested and determined to be safe to operate in parallel with the Distribution System.

2 Application Submission

2.1. Initial Interconnection Application for the MN Study Process

For proposed DER interconnections that are not initially applied for under the Fast Track Process, the Interconnection Customer shall complete the Interconnection Application and submit it to the Area EPS Operator to initiate the Interconnection Process. A completed Interconnection Application will include the following:

- A completed Interconnection Application signed by the Interconnection Customer.
- A process fee not to exceed \$1,000, plus \$2.00 per kW, toward the deposit of the study(s) indicated in Section 4.
- A site layout drawing of the proposed DER system.
- A one-line diagram of the proposed DER system showing the Point of Common Coupling to the Area EPS Operator's Distribution System.
- All equipment manufacturer specification sheets.
- Documentation of site control as indicated in Section 2.4.

2.2. Professional Licensed Engineer Signature

The one-line diagram submitted with the Interconnection Application will require a signature from a professional engineer licensed in the State of Minnesota certifying the DER was designed in conformance to the Minnesota Technical Requirements for the following conditions:

- Certified¹ equipment is greater than 250 kW.
- Non-certified equipment is greater than 20 kW.

2.3. Battery Storage

An inverter-based DER system may include battery storage. DER systems that include battery storage should complete the Energy Storage Application along with the Interconnection Application.

2.4. Site Control

Documentation of site control must be submitted with the Interconnection Application. Site control¹ may be demonstrated by any of the following:

- Ownership of, a leasehold interest in, or a right to develop a site for the purpose of constructing the DER system;
- An option to purchase or acquire a leasehold site for constructing the DER system;
- An exclusivity or other business relationship between the Interconnection Customer and the entity having the right to sell, lease, or grant the Interconnection Customer the right to possess or occupy a site for constructing the DER system.

2.5. Interconnection Applications from Other Processes

Some Interconnection Applications submitted under the MN Fast Track Process may be moved into the MN Study Process due to issues with the DER interconnection identified by engineering screens. An Area EPS Operator cannot request a new Interconnection Application submission if the Interconnection Application has already been submitted through the MN Fast Track Process. The Interconnection Customer who had already

¹ Additional information regarding certified equipment is found in Section 14 of the Process Overview document, the Technical Specifications Manual adopted by the Area EPS Operator (Chapter 8 of the DG Workbook – MN), and the Minnesota Technical Interconnection and Interoperability Requirements approved by the Minnesota Public Utilities Commission in Docket No. E-999/CI-16-521.

paid a processing fee for the MN Fast Track Process is still responsible to make a deposit toward the applicable studies addressed in Sections 4, 5 and 6, but does not need to submit an additional processing fee.

3 Initial Steps

3.1. Completeness Review and Queue Position

The Interconnection Application originally submitted under the MN Study Process shall be date- and time-stamped upon initial receipt, and if necessary, resubmission receipt. The Interconnection Customer shall be notified of receipt by the Area EPS Operator within ten (10) Business Days after receiving the Interconnection Application.

The Area EPS Operator shall notify the Interconnection Customer, within ten (10) Business Days, if the Interconnection Application is deemed incomplete and provide a written list detailing all information that must be provided to complete the Interconnection Application. The Interconnection Customer has ten (10) Business Days, to provide the missing information, unless the Interconnection Customer submits a valid request for a timeline extension. Failure to submit the requested information, within the stated timeline, will result in the Interconnection Application being deemed withdrawn. The Area EPS Operator has an additional five (5) Business Days to review the additionally provided information for completeness.

An Interconnection Application will be deemed complete upon submission to the Area EPS Operator, provided all documents, fees and information required with the Interconnection Application, adhering to Minnesota Technical Requirements, is included. The date- and time-stamp of the completed Interconnection Application shall be accepted as the qualifying date for the purpose of establishing a queue position, as described in Section 4.7 of the Process Overview document.

Interconnection Applications already screened in the MN Simplified Process or MN Fast Track Process shall retain their original queue position in the MN Study Process provided all applicable timelines were met.

3.2. Scoping Meeting

A scoping meeting shall be held within ten (10) Business Days after the Interconnection Application submitted under the MN Study Process is deemed complete. For Interconnection Applications that were submitted under or processed through the Fast Track Process, the scoping meeting will occur within ten (10) Business Days after the Interconnection Customer has elected to continue with the MN Study Process. The scoping meeting timeline may be extended upon mutual agreement of both Parties. The scoping meeting may also be omitted by mutual agreement.

The purpose of the scoping meeting is to discuss the Interconnection Application and review existing study results relevant to the Interconnection Application. The Parties shall further discuss whether the Area EPS Operator should perform a MN System Impact Study or Studies, or proceed directly to a MN Facilities Study or a MN Interconnection Agreement. If the Area EPS Operator determines there is no potential for Transmission System or Distribution System adverse system impacts, the Interconnection Application shall proceed directly to a MN Facilities Study or an executable MN Interconnection Agreement, as agreed to by the Parties.

4 System Impact Study

4.1. Electric System Impacts

A MN System Impact Study shall identify and detail the electric system impacts that would result if the proposed DER(s) were interconnected without project modifications or electric system modifications. The MN System Impact Study is also to study the potential impacts, including but not limited to, those identified in the scoping meeting. A MN System Impact Study shall evaluate the impacts of the proposed interconnection on the reliability of the electric system.

4.2. MN System Impact Study Agreement

If the Parties agree at the scoping meeting that a MN System Impact Study should be performed, the Area EPS Operator shall provide the Interconnection Customer a MN System Impact Study Agreement, not later than five (5) Business Days after the scoping meeting. If the scoping meeting was omitted by mutual agreement, the Area EPS Operator shall provide the Interconnection Customer a MN System Impact Study Agreement within ten (10) Business Days after the Interconnection Customer waives the scoping meeting.

The MN System Impact Study Agreement shall include an outline of the scope of the study and a non-binding good faith estimate of the cost to perform the study. If applicable, the MN System Impact Study Agreement shall list any additional and reasonable technical data on the DER needed to perform the study. The scope and cost responsibilities are to be described in the MN System Impact Study Agreement.

4.3. System Impact Study Costs

A deposit of the good faith estimated cost for each MN System Impact Study shall be provided by the Interconnection Customer with the return of a signed MN System Impact Study Agreement.

4.4. System Impact Study Timelines

Both the Area EPS Operator and the Interconnection Customer have timeline responsibilities under the MN System Impact Study.

4.4.1. Interconnection Customer Timelines

In order to remain in consideration for interconnection, an Interconnection Customer who has requested a MN System Impact Study shall meet the following conditions within twenty (20) Business Days of being provided a MN System Impact Study Agreement:

- Return a signed MN System Impact Study Agreement.
- Provide to the Area EPS Operator any requested additional and reasonable technical data on the DER needed to perform the MN System Impact Study.
- Pay the required study deposit.

Upon the Interconnection Customer's request, the Area EPS Operator shall grant a time frame extension as described in Section 9.2, if additional technical data is requested.

4.4.2. Area EPS Operator Timelines

A MN System Impact Study shall be completed within thirty (30) Business Days after the MN System Impact Study Agreement has been signed by both Parties and delivered with the deposit and requested technical information to the Area EPS Operator. The results of the MN System Impact Study shall be delivered to the Interconnection Customer within five (5) Business Days of completion of the MN System Impact Study. Upon request, the Area EPS Operator shall provide the Interconnection Customer supporting documentation developed in the preparation of the MN System Impact Study, subject to confidentiality arrangements consistent with Section 12.1 of the MN Interconnection Process Overview and terms of the MN System Impact Study Agreement.

5 Transmission System Impact Study

5.1. Transmission System Impacts

In instances where the System Impact Study shows potential for Transmission System adverse system impacts, the Area EPS Operator shall contact the appropriate

Transmission Provider within five (5) Business Days following the identification of such impacts. The Area EPS Operator shall coordinate with the Area EPS Operator's Transmission Provider to have the necessary studies to determine if the DER causes any adverse transmission impacts. The appropriate Transmission Provider shall provide a MN Transmission System Impact Study Agreement for the Interconnection Customer. Included in the MN Transmission System Impact Study Agreement will be a non-binding, good faith estimate of cost for the study, along with a scope outline of the study and any additional technical data required to complete the MN Transmission System Impact Study.

5.2. MN Transmission System Impact Study Timelines

In order to remain in consideration for interconnection, an Interconnection Customer must return the executed MN Transmission System Impact Study Agreement, along with the study deposit, within fifteen (15) Business Days. The MN Transmission System Impact Study shall be completed and the results provided to the Interconnection Customer in as timely a manner as possible, after the MN Transmission System Impact Study Agreement is signed by the Parties. The Area EPS Operator shall be responsible for coordination with the Transmission Provider, as needed. Affected Systems shall participate in the study and provide all information necessary to prepare the study.

5.3. Regional Transmission Operator Jurisdiction

In certain circumstances the Transmission Provider may not be able to study a proposed DER system if there is a possible impact to the bulk Transmission System. In these situations, the Area EPS Operator will coordinate with the Transmission Provider to inform the Interconnection Customer that the proposed DER system will need to follow the Regional Transmission Operator's interconnection process. For most of Minnesota, the Regional Transmission Operator is the Midcontinent Independent System Operator (MISO).

6 Facilities Study

6.1. Construction of Facilities

If construction of facilities is required, a MN Facility Study may be necessary to specify and estimate the cost of the equipment, engineering, procurement and construction work. A MN Facility Study is identified by an Initial Review, Supplemental Review or the MN Study Process to provide interconnection and interoperability of the DER with the Area EPS Operator's Distribution System as required by Minnesota Technical Requirements. At the determination of the Area EPS Operator, Interconnection Applications reviewed in the MN Simplified Process or the MN Fast Track Process that require construction of facilities may forgo a MN Facilities Study.

6.2. MN Facilities Study Agreement

The Area EPS Operator shall provide the Interconnection Customer a MN Facilities Study Agreement either:

- in tandem with the results of the Interconnection Customer's MN System Impact Study, or
- in tandem with a MN Transmission System Impact Study, or
- if no MN System Impact Study is required, within five (5) Business Days after the scoping meeting, or
- within ten (10) Business Days after the MN Interconnection Application is deemed complete and approved through the MN Simplified Process or MN Fast Track Process.

The MN Facilities Study Agreement shall be accompanied by an outline of the scope of the study and a non-binding good faith estimate of the cost to perform the MN Facilities Study. The scope of and cost responsibilities for the MN Facilities Study are to be described in the MN Facilities Study Agreement. A deposit of the good faith estimated costs for the MN Facilities Study shall be provided by the Interconnection Customer at the time it returns the MN Facilities Study Agreement.

6.3. Facilities Study Timeline

In order to remain under consideration for interconnection, the Interconnection Customer must return the executed MN Facilities Study Agreement and pay the required study deposit within fifteen (15) Business Days.

6.4. Identification of Construction of Facilities

The MN Facilities Study shall specify and estimate the cost of the equipment, engineering, procurement and construction work (including overheads), needed to implement the conclusions of the MN System Impact Study(-ies). Design for any required Interconnection Facilities and/or Upgrades shall be performed under the MN Facilities Study Agreement unless the MN Facilities Study Agreement was deemed unnecessary by the Area EPS Operator. However, in the event that the Interconnection Customer did not provide the Area EPS Operator all required Conditional Use Permits at the time of entering into the MN Facilities Study Agreement, any such Design and/or Upgrades by the Area EPS Operator may be delayed until after the Interconnection Customer has provided to the Area EPS Operator all required Conditional Use Permits or

provides a final design. The information in the Conditional Use Permits, or changes to the design, may result in significant modifications to the planned design and/or Upgrades. The Interconnection Customer may send to the Area EPS Operator a redacted version of the Conditional Use Permit(s) to ensure confidentiality, but any and all information that the Area EPS Operator would reasonably need to perform an accurate MN Facilities Study shall not be redacted. If necessary to comply with these requirements, a confidential version of the Conditional Use Permit(s) may be provided to the Area EPS Operator, with the confidential information being clearly marked and subjected to Confidentiality provisions in the MN Interconnection Process Overview document Section 12.1.

The Area EPS Operator may contract with consultants to perform activities required under the MN Facilities Study Agreement. The Interconnection Customer and the Area EPS Operator may agree to allow the Interconnection Customer to separately arrange for the design of some of the Interconnection Facilities. In such cases, facilities design will be reviewed and/or modified prior to acceptance by the Area EPS Operator, under the provisions of the MN Facilities Study Agreement. The Area EPS Operator shall make sufficient information available to the Interconnection Customer, in accordance with confidentiality and critical infrastructure requirements, to permit the Interconnection Customer to obtain an independent design and cost estimate for any necessary facilities.

6.5. MN Facilities Study Report Timeline

In cases where Upgrades are required, the MN Facilities Study must be completed within forty-five (45) Business Days of the receipt of the executed MN Facilities Study Agreement and deposit. In cases where no Upgrades are necessary, and the required facilities are limited to Interconnection Facilities, the MN Facilities Study must be completed within thirty (30) Business Days of the receipt of the executed MN Facilities Study Agreement and deposit.

Once the MN Facilities Study is completed, a draft MN Facilities Study Report shall be prepared and transmitted to the Interconnection Customer. Upon request, the Area EPS Operator shall provide the Interconnection Customer supporting documentation developed in the preparation of the MN Interconnection Facilities Study, subject to confidentiality arrangements consistent with these procedures and the MN Facilities Study Agreement.

Within ten (10) Business Days of providing a draft MN Facilities Study Report to the Interconnection Customer, the Area EPS Operator and Interconnection Customer shall meet to discuss the results of the MN Facilities Study. This meeting may be omitted by

mutual agreement. The Interconnection Customer may, within twenty (20) Business Days after receipt of the draft report, provide written comments to the Area EPS Operator, which the Area EPS Operator shall address in the final report.

The Area EPS Operator shall issue the final Facilities Study Report within fifteen (15) Business Days of receiving the Interconnection Customer's comments, or promptly upon receiving the Interconnection Customer's statement that they will not provide comments. The Area EPS Operator may reasonably extend the time frame, upon notice to the Interconnection Customer, if the Interconnection Customer's comments require additional analyses or lead to significant modifications by the Area EPS Operator prior to issuance of the final Facilities Study Report.

7 Interconnection Agreement

7.1. MN Standard Agreement

For a proposed interconnection that meets the conditions of being classified as a qualifying facility less than 40 kW, the Area EPS Operator shall provide the Interconnection Customer with an executable copy of the Area EPS Operator's MN Standard Agreement, within five (5) Business Days after the completion of the applicable study(-ies).

7.2. MN Interconnection Agreement

For proposed interconnections that do not meet the conditions of being classified as a qualifying facility 100 kW or less, or if requested by the Interconnection Customer in lieu of signing the MN Standard Agreement, the Area EPS Operator shall provide the Interconnection Customer an executable MN Interconnection Agreement (MN Interconnection Agreement), within five (5) Business Days after the completion of the applicable study(-ies).

7.3. Completion of Agreement

The Interconnection Customer must return a signed MN Standard Agreement or MN Interconnection Agreement thirty (30) Business Days prior to the requested in-service date of the propose DER. The Area EPS Operator shall sign and return a copy of the fully executed MN Standard Agreement or the MN Interconnection Agreement back to the Interconnection Customer.

The Interconnection Customer may update the requested in-service date submitted on the Interconnection Application to a date thirty (30) Business Days or later from the date on which the Interconnection Customer submits a signed MN Standard Agreement

or MN Interconnection Agreement and payment if required unless the Area EPS Operator agrees to an earlier date.

Upon receipt of the signed MN Standard Agreement or MN Interconnection Agreement, the Area EPS Operator may schedule appropriate metering replacements and construction of facilities, if necessary.

8 Insurance

8.1. Insurance Requirements

At minimum, the Interconnection Customer shall maintain, for the duration the DER system is interconnected to the Area EPS Operator’s Distribution System, general liability insurance from a qualified insurance agency with a B+ or better rating by “Best,” with a combined single limit of not less than described in Table 8.1. Such general liability insurance shall include coverage against claims for damages resulting from (i) bodily injury, including wrongful death; and (ii) property damage arising out of the Interconnection Customer’s ownership and/or operation of the DER under this agreement. Evidence of the insurance shall state that coverage provided is primary and is not excess to or contributing with any insurance or self-insurance by the Area EPS Operator.

Table 8.1 Liability Insurance Requirements

DER System Size	Liability Insurance Requirement
< 40 kW AC	\$300,000
≥ 40 kW AC and < 250 kW AC	\$1,000,000
≥ 250 kW AC and < 5 MW AC	\$2,000,000
≥ 5 MW AC	\$3,000,000

For all proposed DER systems, except those that are qualifying systems less than 40 kW AC, the general liability insurance shall, by endorsement to the policy or policies:

- Include the Area EPS Operator as additionally insured;
- Contain a severability of interest clause or cross-liability clause;
- Provide that the Area EPS Operator shall not by reason incur liability to the insurance carrier for the payment of premiums for such insurance if the Area EPS Operator is included as an additionally insured.

8.2. Proof of Insurance

The Interconnection Customer shall furnish the required insurance certificates and endorsements to the Area EPS Operator prior to the initial operation of the DER. A copy

of the Declaration page of the homeowner's insurance policy is a common example of an insurance certificate. Thereafter, the Area EPS Operator shall have the right to periodically inspect or obtain a copy of the original policy or policies of insurance. Additionally, the Area EPS Operator may request to be additionally listed as an interested third party on the insurance certificates and endorsements for qualifying facilities less than 40 kW AC, to meet the right to periodically obtain a copy of the policy or policies of insurance.

9 Timeline Extensions

9.1. Reasonable Efforts

The Area EPS Operator shall make Reasonable Efforts to meet all the time frames provided in these procedures. If the Area EPS Operator cannot meet a deadline provided herein, it must notify the Interconnection Customer in writing within three (3) Business Days after the deadline, explaining the reason for the failure to meet the deadline and providing an estimated time by which it will complete the applicable interconnection procedure in the process.

9.2. Extensions

For applicable time frames described in these procedures, the Interconnection Customer may request in writing one extension equivalent to half of the time originally allotted (e.g. ten (10) Business Days for a twenty (20) Business Days original time frame), which the Area EPS Operator may not unreasonably refuse. No further extensions for the applicable time frame shall be granted absent a Force Majeure Event or other similarly extraordinary circumstance.

10 Modifications to Application

10.1. Procedures

At any time after the Interconnection Application is deemed complete, the Interconnection Customer or the Area EPS Operator may identify modifications to the proposed DER system that may improve costs and benefits (including reliability) of the proposed DER system and the ability for the Area EPS Operator to accommodate the proposed DER system. The Interconnection Customer shall submit to the Area EPS Operator, in writing, all proposed modifications to any information provided in the Interconnection Application. The Area EPS Operator cannot unilaterally modify the Interconnection Application.

10.2. Timelines

Within ten (10) Business Days of receipt of the proposed modification, the Area EPS Operator shall evaluate whether the proposed modification to the Interconnection Application constitutes a Material Modification. The definition of Material Modification in the Section 13 Glossary of the Process Overview document includes examples of what does and does not constitute a Material Modification.

The Area EPS Operator shall notify the Interconnection Customer in writing of the final determination of the proposed modification. For proposed modifications that are determined to be a Material Modification the Interconnection Customer may choose to either: 1) withdraw the proposed modification; or 2) proceed with a new Interconnection Application. The Interconnection Customer shall provide its choice in writing to the Area EPS Operator within ten (10) Business Days after being provided the Material Modification determination. If the Interconnection Customer does not provide its choice within the timeline, the Interconnection Application shall be considered withdrawn.

If the proposed modification is not determined to be a Material Modification, then the Area EPS Operator shall notify the Interconnection Customer in writing that the modification has been accepted and the Interconnection Customer shall retain its eligibility for interconnection, including its position in the queue.

11 Interconnection

11.1. Interconnection Milestones

For DER systems that are not a qualifying facility less than 40 kW AC, the Interconnection Customer and the Area EPS Operator shall agree on milestones for which each Party is responsible and list them in Attachment IV in the MN Interconnection Agreement. To the greatest extent possible, the Parties will identify all design, procurement, installation and construction requirements associated with the project, and clear associated timelines, at the beginning, or as early within the process as possible, of the design, procurement, installation and construction phase.

A Party's obligation under this provision may be extended by agreement. If a Party anticipates that it will be unable to meet a milestone for any reason other than a Force Majeure Event, it shall immediately notify the other Party of the reason(s) for not meeting the milestone, propose the earliest reasonable alternative date in which this and future milestones will be met, and request appropriate amendments to the MN Interconnection Agreement and its attachments. The Party affected by the failure to meet a milestone shall not unreasonably withhold agreement to such an amendment

unless:

- The Party will suffer significant uncompensated economic or operational harm from the delay, or
- Attainment of the same milestone has previously been delayed, or
- The Party has reason to believe the delay in meeting the milestone is intentional or unwarranted notwithstanding the circumstance explained by the Party proposing the amendment.

If the Party affected by the failure to meet a milestone disputes the proposed extension, the affected Party may pursue dispute resolution as described in the MN Interconnection Process Overview document.

11.2. Metering

Any metering requirements necessitated by the use of the DER system shall be installed at the Interconnection Customer's expense. The metering-related costs will be included in the final invoice of interconnection costs to the Interconnection Customer. The Interconnection Customer is also responsible for metering replacement costs not covered in the Interconnection Customer's general customer charge. The Area EPS Operator may charge Interconnection Customers an ongoing metering-related charge for an estimate of ongoing metering-related costs specifically demonstrated.

11.3. Inspection, Testing and Commissioning

Upon completing construction of the DER system, the Interconnection Customer will cause the DER system to be inspected or otherwise certified by the appropriate local electrical wiring inspector with jurisdiction. The Interconnection Customer shall then arrange for the inspection and testing of the DER system and the Customer's Interconnection Facilities prior to interconnection pursuant to Minnesota Technical Requirements. Commissioning tests of the Interconnection Customer's installed equipment shall be performed pursuant to applicable codes and standards set forth in the Minnesota Technical Requirements.

The Interconnection Customer shall notify the Area EPS Operator of testing and inspection no fewer than five (5) Business Days in advance, or as may be agreed to by the Parties. The Interconnection Customer shall provide to the Area EPS Operator a testing procedure that will be followed on the day of testing and inspection no fewer than ten (10) Business Days prior to the testing and inspection date. The testing procedure should include tests and/or inspections to confirm the DER system will meet

the Minnesota Technical Requirements for interconnection. The Area EPS Operator shall review the testing procedure for completeness and shall notify the Interconnection Customer if the testing procedure fails to address components of the technical requirements for interconnection.

The Area EPS Operator shall send qualified personnel to the DER site to inspect the interconnection and witness the testing, but the Area EPS Operator bears no liability for the results of the test. Testing and inspection shall occur on a Business Day at a mutually agreed upon date and time. The Area EPS Operator may waive the right to witness the testing.

11.4. Interconnection Costs

11.4.1 Estimation of Interconnection Costs

The Interconnection Customer shall pay for the actual cost of the Interconnection Facilities and Distribution Upgrades along with the Area EPS Operator's cost to commission the proposed DER system. An estimate of the interconnection costs shall be stated in the MN Standard Agreement or in the MN Interconnection Agreement as a detailed itemization of such costs. If Network Upgrades are required, the actual cost of the Network Upgrades, including overheads, shall be borne by the Interconnection Customer pursuant to the Transmission Provider and associated agreements.

11.4.2 Progressive Payment of Interconnection Costs

The Area EPS Operator shall invoice the Interconnection Customer for the design, engineering, construction and procurement costs of the Interconnection Facilities and Upgrades described in the MN Interconnection Agreement on a monthly basis or other basis agreed upon by both Parties in the MN Interconnection Agreement or as listed in the MN Standard Agreement. The Interconnection Customer shall pay each invoice within twenty-one (21) Business Days or as agreed to in the MN Interconnection Agreement or MN Standard Agreement.

11.4.3 Final Accounting of Interconnection Facilities and Upgrade Costs

If distribution or transmission facilities required upgrades to accommodate the proposed DER system, the Area EPS Operator shall render the final interconnection cost invoice to the Interconnection Customer within eighty (80) Business Days (approximately four calendar months) of completing the construction and installation of the Area EPS Operator's Interconnection Facility and Upgrades. The Area EPS Operator shall provide the Interconnection Customer with a final accounting report identifying the difference between the

actual Interconnection Customer's cost responsibility and the Interconnection Customer's previous aggregate payments to the Area EPS Operator for the specific DER system interconnection. Upon the final accounting submitted to the Interconnection Customer, the balance between the actual cost and previously aggregated payments shall be paid to the Area EPS Operator within twenty (20) Business Days. If the balance between the actual cost and previously aggregated payments is a credit, the Area EPS Operator shall refund the Interconnection Customer within twenty (20) Business Days.

11.4.4 Final Interconnection Costs without Facilities and Upgrades Needed

Within thirty (30) Business Days the final invoice for the interconnection costs shall be rendered to the Interconnection Customer once the proposed DER system has been commissioned by the Area EPS Operator, or upon the commissioning being waived by the Area EPS Operator. The Interconnection Customer shall make payment to the Area EPS Operator within twenty-one (21) Business Days of receipt, or as otherwise stated in the MN Standard Agreement or MN Interconnection Agreement.

11.5. Security of Payment

At the option of the Area EPS Operator, either the "Traditional Security" or the "Modified Security" method shall be used for assurance of payment of interconnection cost.

Under the Traditional Security method, the Interconnection Customer shall provide reasonable, adequate assurances of credit, including a letter of credit or personal guaranty of payment and performance from a creditworthy entity acceptable under the Area EPS Operator credit policy. The letter of credit shall also include procedures for the unpaid balance of the estimated amount shown in the MN Interconnection Agreement for the totality of all anticipated work or expense incurred by the Area EPS Operator associated with the Interconnection Application. The payment for these estimated costs shall be as follows:

- One-third of estimated costs shall be due no later than when the Interconnection Customer signs the MN Interconnection Agreement.
- An additional one-third of estimated costs shall be due prior to initial energization of the DER with the Area EPS Operator.

- Remainder of actual costs, incurred by Area EPS Operator, shall be due within thirty (30) Business Days from the date the invoice is mailed by the Area EPS Operator after project completion.

Under the Modified Security method, at least twenty (20) Business Days prior to the commencement of the design, procurement, installation, or construction of a discrete portion of the Area EPS Operator's Interconnection Facilities and Upgrades, the Interconnection Customer shall provide the Area EPS Operator, at the Interconnection Customer's option, a guarantee, letter of credit or other form of security that is reasonably acceptable to the Area EPS Operator and is consistent with the Minnesota Uniform Commercial Code. Such security for payment shall be in an amount sufficient to cover the costs for constructing, designing, procuring, and installing the applicable portion of the Area EPS Operator's Interconnection Facilities and Upgrades and shall be reduced on a dollar-for-dollar basis for payments made to the Area EPS Operator under the MN Interconnection Agreement during its term.

The guarantee must be made by an entity that meets the creditworthiness requirements of the Area EPS Operator and contain terms and conditions that guarantee payment of any amount that may be due from the Interconnection Customer, up to an agreed-to maximum amount.

The letter of credit must be issued by a financial institution or insurer reasonably acceptable to the Area EPS Operator and must specify a reasonable expiration date not sooner than sixty (60) Business Days, (three calendar months), after the due date of the final accounting report and invoice described in Section 11.4.

11.6. Non-Warranty

Area EPS Operator does not give any warranty, expressed or implied, as to the adequacy, safety, or other characteristics of any structures, equipment, wires, appliances or devices owned, operated, installed or maintained by the Interconnection Customer, including without limitation the DER and any structures, equipment, wires, appliances or devices not owned, operated or maintained by the Area EPS Operator. The Area EPS Operator does not guarantee uninterrupted power supply to the DER and will operate the Distribution System with the same reliability standards for the entire customer base.

11.7. Authorization for Parallel Operation

The Interconnection Customer shall not operate its DER system in parallel with the Area EPS Operator's Distribution System without prior written authorization from the Area EPS Operator. The Area EPS Operator shall provide such authorization within three (3)

Business Days from when the Area EPS Operator receives notification that the Interconnection Customer has complied with all applicable parallel operations requirements and commissioning has been successfully completed. Such authorization shall not be unreasonably withheld, conditioned or delayed.

11.8. Continual Compliance

The Interconnection Customer shall operate its DER system in compliance with the Area EPS Operator's Minnesota Technical Requirements referred to in the executed MN Standard Agreement or MN Interconnection Agreement. The Area EPS Operator may periodically inspect, at its own expense, the operation of DER system as it relates to power quality, thermal limits and reliability. Failure by the Interconnection Customer to remain in compliance with the Minnesota Technical Requirements will result in the disconnection of the DER system from the Area EPS Operator's Distribution System.

11.9. Disconnection of DER

The Area EPS Operator has the right to disconnect the DER in the event of the following:

- The Interconnection Customer does not continue to follow and maintain IEEE 1547 settings or functions as required by the Minnesota Technical Requirements.
- The DER does not meet all the requirements of the MN Study Process.
- The Interconnection Customer refuses to sign either the MN Interconnection Agreement or the Area EPS Operator's MN Standard Agreement.

The Area EPS Operator may temporarily disconnect the DER upon the following conditions:

- For scheduled outages upon reasonable notice.
- For unscheduled outages or emergency conditions.
- If the DER does not operate in a manner consistent with the MN Study Process.

The Area EPS Operator shall inform the Interconnection Customer in advance of any scheduled disconnections, or as reasonable, after an unscheduled disconnection.

Interconnection Application

Persons interested in applying for the interconnection of a distributed energy resource to the Local Utility’s distribution system through the Fast Track or Study Processes are to fill out this Interconnection Application. The Interconnection Application is to be filled out completely by the applicant or as noted in each section of the application. The Local Utility will contact the applicant within 10 business days once the Interconnection Application and the corresponding processing fee is submitted to the Local Utility. The Local Utility will then notify the applicant of the completeness of their application. If the application is deemed incomplete by the Local Utility, the Local Utility will provide the applicant with a list of missing material. The applicant will then have 10 business days to provide the Local Utility with this information or request an extension, otherwise the application will be deemed incomplete and the applicant will lose their place in the queue. Sections that are noted with * are required to be filled out.

Checklist for Submission to Local Utility	
<i>The items below shall be included with submittal of the Interconnection Application to the Local Utility. Failure to include all items will deem the Interconnection Application incomplete.</i>	
	Included
Non-Refundable Processing Fee Fast Track <ul style="list-style-type: none"> • \$100 + \$1/kW for Certified Systems • \$100 + \$2/kW for Non-Certified Systems Study Process <ul style="list-style-type: none"> • \$1,000 + \$2/kW down payment. Additional study fees may apply. 	<input type="checkbox"/> Yes
One-line diagram <ul style="list-style-type: none"> • This one-line diagram must be signed and stamped by a Professional Engineer licensed in Minnesota if the DER is uncertified greater than 20 kW AC or if certified system is over 250 kW. • Details required on one-line diagram specified at the end of the interconnection application and in Local Utility’s Technical Specifications Manual (TSM) 	<input type="checkbox"/> Yes
Schematic drawings for all protection and control circuits, relay current circuits, relay potential circuits, and alarm/monitoring circuits	<input type="checkbox"/> Yes
Inverter Specification Sheet(s) (if applicable)	<input type="checkbox"/> Yes
Documentation that describes and details the operation of protection and control schemes	<input type="checkbox"/> Yes
Documentation showing site control	<input type="checkbox"/> Yes
Aerial map showing DER system layout including major roadways and true north (See TSM for more details)	<input type="checkbox"/> Yes
<u>Possible Additional Documentation (See TSM for more details)</u>	
<ul style="list-style-type: none"> • If the DER export capacity is limited, include information material explaining the limiting capabilities. • If Energy Storage is included with the proposed DER system, include the Energy Storage Application. 	

General *	
Select Review Process: <input type="checkbox"/> Fast Track Process <input type="checkbox"/> Study Process	
Application is for:	<input type="checkbox"/> New Distributed Energy Resource <input type="checkbox"/> Capacity Addition or Material Modification to Existing Distributed Energy Resource
If Capacity Addition or Material Modification to existing facility, please describe:	
Distributed Energy Resource will be used for what reason? (Check all that apply):	
<input type="checkbox"/> Net Metering <input type="checkbox"/> Supply Power to Interconnection Customer <input type="checkbox"/> Supply Power to Area EPS	
Installed DER System Cost (before incentives):	\$

Interconnection Customer *		
Full Name (must match the name of the existing service account):		
Account Number:	Meter Number:	
Mailing Address:		
City:	State:	Zip Code:
Email:	Phone:	

** Indicates section must be completed.*

Application Agent *	
Is the Customer using an Application Agent for this application?	<input type="checkbox"/> Yes <input type="checkbox"/> No
<i>If Interconnection Customer is not using an Application Agent, please skip to the next section.</i>	
Application Agent:	
Company Name:	
Email:	Phone:

Distributed Energy Resource Information *	
Estimated Installation Date:	
Location (if different from mailing address of Interconnection Customer):	
Will the Proposed DER system be interconnected to an existing electric service?	<input type="checkbox"/> Yes <input type="checkbox"/> No
Is the Distributed Energy Resource a single generating unit or multiple?	<input type="checkbox"/> Single <input type="checkbox"/> Multiple
DER Type (<i>Check all that apply</i>):	
<input type="checkbox"/> Solar Photovoltaic	<input type="checkbox"/> Wind
<input type="checkbox"/> Combined Heat and Power	<input type="checkbox"/> Solar Thermal
	<input type="checkbox"/> Energy Storage
	<input type="checkbox"/> Other (please specify)
<i>DER systems with Energy Storage must also submit the Energy Storage Application to the Local Utility.</i>	
Total Number of Distributed Energy Resources to be interconnected pursuant to this Interconnection Application:	
Phase configuration of Distributed Energy Resource(s):	<input type="checkbox"/> Single Phase <input type="checkbox"/> Three Phase
Type of Generator:	<input type="checkbox"/> Inverter <input type="checkbox"/> Synchronous <input type="checkbox"/> Induction
Aggregate DER Capacity (the sum of nameplate capacity of all generation and storage devices at the PCC):	
kW_{ac}	kVA_{ac}

** Indicates section must be completed.*

Export Capacity Limitation *	
Is the export capability of the DER limited?	<input type="checkbox"/> Yes <input type="checkbox"/> No
<i>If the DER export capacity is limited, complete the following sections and include information material to explaining the limiting capabilities.</i>	
Maximum Physical Export Capacity Requested:	kW_{ac}
If Yes, please provide additional details describing method of export limitation:	

Load Information *	
Interconnection Customer's or Customer-sited Load:	kW_{ac}
Typical Reactive Load (if known):	

Equipment Certification *	
Is the DER equipment certified? ¹	<input type="checkbox"/> Yes <input type="checkbox"/> No
<i>Please list all IEEE 1547 certified equipment below. Include all certified equipment manufacturer specification sheets with the Interconnection Application submission.</i>	
Equipment Type	Certifying Entity
1	
2	
3	
4	

* Indicates section must be completed.

¹ Information regarding certified equipment can be found in Section 14 of the Process Overview (Chapter 4), the Technical Specifications Manual (Chapter 8), and the Minnesota Technical Interconnection and Interoperability Requirements approved by the Minnesota Public Utilities Commission in Docket No. E-999/CI-16-521.

Prime Mover *		
Please indicate the prime mover:		
<input type="checkbox"/> Solar Photovoltaic	<input type="checkbox"/> Microturbine	<input type="checkbox"/> Fuel Cell
<input type="checkbox"/> Reciprocating Engine	<input type="checkbox"/> Gas Turbine	<input type="checkbox"/> Other (please specify)
Is the prime mover compatible with certified protection equipment package?		<input type="checkbox"/> Yes <input type="checkbox"/> No
DER Manufacturer:	Model Name & Number:	Version:
List of Adjustable Set Points for Protection Equipment or Software:		
Summer Name Plate Rating:	kW_{ac}	Summer Name Plate Rating: kW_{ac}
Winter Name Plate Rating:	kVA_{ac}	Winter Name Plate Rating: kVA_{ac}
Rated Power Factor:	Leading:	Lagging:
<i>A completed Power System Load Flow data sheet must be supplied with the Interconnection Application.</i>		

Only appropriate sections beyond this point until the signature page are to be completed.

Distributed Energy Resource Characteristic Data (for Inverter-based machines)	
Max design fault contribution current:	
Is your response to the previous field an Instantaneous or RMS measurement?	<input type="checkbox"/> Instantaneous <input type="checkbox"/> RMS
Harmonic Characteristics:	
Start-up Requirements:	

** Indicates section must be completed.*

Distributed Energy Resource Characteristic Data (for Synchronous machines)	
RPM Frequency:	Neutral Grounding Resistor:
Direct Axis Synchronous Reactance, X_d :	Zero Sequence Reactance, X_0 :
Direct Axis Transient Reactance, X'_d :	KVA Base:
Direct Axis Subtransient Reactance, X''_d :	Field Volts:
Negative Sequence Reactance, X_2 :	Field Amperes:
Please provide the appropriate IEEE model block diagram of excitation system, governing system and power system stabilizer (PSS) in accordance with the regional reliability council criteria. A PSS may be determined to be required by applicable studies. A copy of the manufacturer's block diagram may not be submitted.	

Distributed Energy Resource Characteristic Data (for Induction machines)	
RPM Frequency:	Neutral Grounding Resistor:
Motoring Power (kW):	Exciting Current:
Heating Time Constant:	Temperature Rise:
Rotor Resistance, R_r :	Frame Size:
Stator Resistance, R_s :	Design Letter:
Stator Reactance, X_s :	Reactive Power Required In Vars (No Load):
Rotor Reactance, X_r :	Reactive Power Required In Vars (Full Load):
Magnetizing Reactance, X_m :	Total Rotating Inertia, H:
Short Circuit Reactance, X''_d :	

Interconnection Facilities Information			
Will a transformer be used between the DER and the Point of Common Coupling?		<input type="checkbox"/> Yes <input type="checkbox"/> No	
Will the transformer be provided by the Interconnection Customer? If yes, please fill in the fields below.		<input type="checkbox"/> Yes <input type="checkbox"/> No	
Proposed location of protective interface equipment on property:			
Transformer Data (For Interconnection Customer-Owned Transformer)			
What is the phase configuration of the transformer?		<input type="checkbox"/> Single Phase <input type="checkbox"/> Three Phase	
Size (kVA):	Transformer Impedance (%):	On kVA Base:	
Transformer Volts: (Primary)	Delta:	Wye:	Wye Grounded:
Transformer Volts: (Secondary)	Delta:	Wye:	Wye Grounded:
Transformer Volts: (Tertiary)	Delta:	Wye:	Wye Grounded:
Transformer Fuse Data (For Interconnection Customer-Owned Fuse)			
Manufacturer:	Type:	Size:	Speed:
Interconnecting Circuit Breaker (For Interconnection Customer-Owned Circuit Breaker)			
Manufacturer:		Type:	
Load Rating (in Amps):	Interrupting Rating (In Amps):	Trip Speed (Cycles):	
Interconnection Protective Relays (For Microprocessor Controlled Relays)			
Setpoint Function		Minimum	Maximum

Interconnection Protective Relays (For Relays with Discrete Components)			
Manufacturer:	Type:	Style/Catalog No.:	Proposed Setting:
Manufacturer:	Type:	Style/Catalog No.:	Proposed Setting:
Manufacturer:	Type:	Style/Catalog No.:	Proposed Setting:
Manufacturer:	Type:	Style/Catalog No.:	Proposed Setting:
Manufacturer:	Type:	Style/Catalog No.:	Proposed Setting:
Current Transformer Data:			
Manufacturer:	Type:	Accuracy Class:	Proposed Ratio Connection:
Manufacturer:	Type:	Accuracy Class:	Proposed Ratio Connection:
Potential Transformer Data:			
Manufacturer:	Type:	Accuracy Class:	Proposed Ratio Connection:
Manufacturer:	Type:	Accuracy Class:	Proposed Ratio Connection:

For Office Use Only	
Application ID:	
Date Received:	Application Fee Received: <input type="checkbox"/> Yes <input type="checkbox"/> No
Date Completed:	

Interconnection Agreement *

Proposed DER interconnections that are also deemed Qualifying Facilities less than 40 kW AC under Minnesota Statutes § 216B.164 are eligible to sign the Local Utility’s Standard Agreement for Cogeneration and Small Power Production Facilities. Included in this agreement are payment terms for excess power generated by the proposed DER system the Local Utility may purchase. In lieu of the Local Utility’s Standard Agreement for Cogeneration and Small Power Production Facilities, the Interconnection Customer may choose to instead sign the Local Utility’s Interconnection Agreement.

The Interconnection Customer requests an Interconnection Agreement to be executed in lieu of the Local Utility’s Standard Agreement for Cogeneration and Small Power Production Facilities.

Yes No

Disclaimers – Must be completed by Interconnection Customer *

	Initials
The Interconnection Customer has opportunities to request a timeline extension during the interconnection process. Failure by the Interconnection Customer to meet or request an extension for a timeline outlined in the Interconnection Process could result in a withdrawn queue position and the need to re-apply.	
Proposed DER interconnections to the Local Utility’s distribution system submitted under the Fast Track Process may be moved into the Study Process if engineering screens are failed during the Interconnection Application review.	

Application Signature – Must be completed by Interconnection Customer *

I designate the individual or company listed as my Application Agent to serve as my agent for the purpose of coordinating with the Area EPS Operators on my behalf throughout the interconnection process.

_____ Initials

I hereby certify that, to the best of my knowledge, the information provided in this Application is true, and that I have appropriate Site Control in conformance with the Interconnection Process. I agree to abide by the Minnesota Interconnection Process (MIP) and will inform the Local Utility if the proposed DER system changes from the details listed in this Interconnection Application.

Applicant Signature:

Date:

*****Please print clearly or type and return completed along with any additional documentation*****

Information Required on One-Line Diagram

An Interconnection Application must include a site electrical one-line diagram showing the configuration of all Distributed Energy Resource equipment, current and potential circuits, and protection and control schemes. The one-line diagram shall include:

- Applicant name.
- Application ID.
- Installer name and contact information.
- Address where DER system will be installed - must match application address.
 - Be sure to list the address for the protective interface equipment if the protective interface equipment is located at a different address than the DER system.
- Correct positions of all equipment, including but not limited to panels, inverter, and DC/AC disconnect. Include distances between equipment, and any labeling found on equipment.
- Any other information that may be required by the Local Utility's Technical Specifications Manual

This one-line diagram must be signed and stamped by a Minnesota licensed Professional Engineer if the Distributed Energy Resource is larger than 20 kW (if uncertified) and 250 kW (if certified.)

Please see the Local Utility's Technical Specifications Manual for example one-line diagram.

INTERCONNECTION AGREEMENT

For use in lieu of the MN Standard
Agreement

Contents

i.	Contact Information	1
1	Scope and Limitations of Agreement	2
2	Responsibilities of the Parties	3
3	Parallel Operation Obligations	4
4	Metering	4
5	Distributed Energy Resource Capabilities and Grid Reliability	4
6	Equipment Testing and Inspection	5
7	Authorization Required Prior to Parallel Operation	5
8	Right of Access	5
9	Term and Termination	6
10	Disconnection	7
11	Cost Responsibility for Interconnection Facilities and Distribution Upgrades	9
12	Cost Responsibility for Network Upgrades	9
13	Billing, Payment, Milestones, and Financial Security	11
14	Assignment	12
15	Limitations of Liability	12
16	Non-Warranty	12
17	Indemnity	13
18	Force Majeure	13
19	Default	14
20	Insurance	14
21	Confidential Information	15
22	Disputes	15
23	Taxes	15
24	Miscellaneous	15
25	Notices	18
26	Signatures	21

Attachment I: Glossary of Terms.....	22
Attachment II: Description and Costs of the Distributed Energy Resource, Interconnection Facilities, and Metering Equipment	28
Attachment III: One-line Diagram Depicting the Distributed Energy Resource, Interconnection Facilities, and Metering Equipment, and Upgrades.....	29
Attachment IV: Milestones.....	30
Attachment V: Operating Agreement	32
Attachment VI: Maintenance Agreement.....	36
Attachment VII: Area EPS Operator’s Description of Distribution and Network Upgrades and Good Faith Estimates of Upgrade Costs.....	37
Attachment VIII: Assignment of Interconnection Agreement	38

i. Contact Information

Contact information for each Party is listed below along with the basic information describing the Distributed Energy Resource (DER) system.

Area EPS Operator Information

Area EPS Operator: _____

Attention: _____

Address: _____

Phone: _____

Email: _____

Interconnection Customer Information

Interconnection Customer: _____

Attention: _____

Address: _____

Phone: _____

Email: _____

DER System Information

Application Number: _____

Type of DER System: _____

Capacity Rating of System (AC): _____

Limited Capacity Rating (AC): _____

Address of DER System: _____

This Interconnection Agreement (“Agreement”) is made and entered into this ____ day of _____, 20__ by and between _____ (“Interconnection Customer”), and _____, a municipal utility existing under the laws of the State of Minnesota (“Area EPS Operator”). Interconnection Customer and Area EPS Operator each may be referred to as a “Party” or collectively as the “Parties.”

In consideration of the mutual covenants set forth herein, the Parties agree as follows:

1 Scope and Limitations of Agreement

- 1.1. This Agreement is intended to provide for the Interconnection Customer to interconnect at the Point of Common Coupling and operate a Distributed Energy Resource with a Nameplate Rating of 10 Megawatts (MW) or less in parallel with the Area EPS at the location identified above and shown in the one-line diagram in Attachment 3.
- 1.2. This Agreement shall be used for all Interconnection Applications submitted under the Minnesota Interconnection Process (MIP) except for those Interconnection Applications that qualify and choose for the MN Standard Agreement to replace the need for this Agreement.
- 1.3. This Agreement governs the terms and conditions under which the Interconnection Customer’s Distributed Energy Resource will interconnect with, and operate in parallel with, the Area EPS Operator’s Distribution System.
- 1.4. Capitalized terms used herein shall have the meanings specified in the Glossary of Terms in Attachment 1, the MIP, or the body of this Agreement.
- 1.5. This Agreement does not constitute an agreement to purchase or deliver the Interconnection Customer’s power. The purchase or delivery of power and other services that the Interconnection Customer may require from the Area EPS Operator, or others, may be covered under separate agreements.
- 1.6. To facilitate the operation of the Distributed Energy Resource, this Agreement also allows for the occasional and inadvertent export of energy to the Area EPS. The amount, metering, billing, and accounting of such inadvertent energy exporting shall be governed by the Operating Agreement in Attachment 5. This Agreement does not constitute an agreement by the Area EPS Operator to purchase or to pay for any energy, inadvertently or intentionally exported, unless expressly noted in Attachment 5 or under a separately executed power purchase agreement (PPA).

- 1.7. This Agreement does not constitute a request for the provision of any transmission delivery service or for any local distribution delivery service. If it is the Interconnection Customer's intent to sell to other parties, the Interconnection Customer shall be responsible for market related charges to the Area EPS Operator or its wholesale power supplier caused by the generator operation.
- 1.8. The Minnesota Technical Requirements for interconnection are covered in a separate document, a copy of which has been made available to the Interconnection Customer and is incorporated and made part of this Agreement by this reference.
- 1.9. Nothing in this Agreement is intended to affect any other agreement between the Area EPS Operator and the Interconnection Customer.

2 Responsibilities of the Parties

- 2.1. The Parties shall perform all obligations of this Agreement in accordance with the MIP, Minnesota Technical Requirements, all Applicable Laws and Regulations, Operating Requirements, and Good Utility Practice.
- 2.2. The Interconnection Customer shall construct, interconnect, operate and maintain its Distributed Energy Resource and construct, operate, and maintain its Interconnection Facilities in accordance with the applicable manufacturer's recommended maintenance schedule, this Agreement, and Good Utility Practice. Prior to the construction of the Distributed Energy Resource, the Interconnection Customer shall obtain all environmental and other permits required by any governmental authorities. The Interconnection Customer shall also maintain and comply with the requirements of these permits during the term of this Agreement.
- 2.3. The Area EPS Operator shall construct, operate, and maintain its Distribution System and its Interconnection Facilities in accordance with this Agreement and Good Utility Practice.
- 2.4. The Parties agree to cause their facilities or systems to be constructed in accordance with the laws of the State of Minnesota and to meet or exceed applicable codes and standards provided by the National Electrical Safety Code, the American National Standards Institute, Institute of Electrical and Electronics Engineers (IEEE), Underwriter's Laboratory (UL), Minnesota Technical Requirements, Operating Requirements, and local building codes and other applicable ordinances in effect at the time of construction. The Interconnection Customer agrees to design, install, maintain, and operate its Distributed Energy Resource so as to reasonably minimize the

likelihood of a disturbance adversely affecting or impairing the system or equipment of the Area EPS Operator and any Affected Systems.

- 2.5. Each Party shall operate, maintain, repair, and inspect, and shall be fully responsible for the facilities that it now owns or subsequently owns unless otherwise specified in the Attachments to this Agreement. Each Party shall be responsible for the safe installation, maintenance, repair and condition of their respective lines and appurtenances on their respective sides of the point of common coupling. The Area EPS Operator and the Interconnection Customer, as appropriate, shall provide Interconnection Facilities that adequately protect the Area EPS Operator's Distribution System, personnel, and other persons from damage and injury. The allocation of responsibility for the design, installation, operation, maintenance and ownership of Interconnection Facilities shall be delineated in the Attachments to this Agreement.
- 2.6. The Area EPS Operator shall coordinate with all Affected Systems to support the interconnection.

3 Parallel Operation Obligations

- 3.1. Once the Distributed Energy Resource has been authorized to commence parallel operation, the Interconnection Customer shall abide by all rules and procedures pertaining to the parallel operation of the Distributed Energy Resource in the applicable control area, including, but not limited to: 1) the rules and procedures concerning the operation of generation set forth by the applicable system operator(s) for the Area EPS Operator's Distribution System provided or referenced in an attachment to this Agreement and; 2) the Operating Requirements set forth in Attachment 5 of this Agreement.

4 Metering

- 4.1. As described in MIP Process Overview Section 9.1, the Interconnection Customer shall be responsible for the Area EPS Operator's reasonable and necessary cost for the purchase, installation, operation, maintenance, testing, repair, and replacement of metering and data acquisition equipment specified in Attachments 2 and 3 of this Agreement. The Interconnection Customer's metering (and data acquisition, as required) equipment shall conform to applicable industry rules and Operating Requirements.

5 Distributed Energy Resource Capabilities and Grid Reliability

- 5.1. The Minnesota Technical Requirements outlines the Parties' responsibilities consistent with IEEE 1547 Standard for Interconnection and Interoperability of Distributed Energy

Resources with Associated Electric Power Systems Interfaces which provides requirements relevant to the interconnection and interoperability performance, operation and testing, and, to safety, maintenance and security considerations.

- 5.2. The Area EPS Operator may offer the Interconnection Customer the option to utilize required DER capabilities to mitigate Interconnection Customer costs related to Upgrades or Interconnection Facilities to address anticipated system impacts from the engineering review (i.e. Initial Review, Supplemental Review, or Study Process described in the MIP).

6 Equipment Testing and Inspection

- 6.1. As described in MIP Process Overview Section 9.2, the Interconnection Customer shall test and inspect its Distributed Energy Resource and Interconnection Facilities prior to interconnection pursuant to Minnesota Technical Requirements and this Agreement.

7 Authorization Required Prior to Parallel Operation

- 7.1. As described in MIP Process Overview Section 9.4, the Area EPS Operator shall use Reasonable Efforts to list applicable parallel operation requirements by providing the Minnesota Technical Requirements with the notice of approval of the Interconnection Application or by providing a website link to the document. Additionally, the Area EPS Operator shall notify the Interconnection Customer of any changes to these requirements as soon as they are known. Pursuant to the MIP Process Overview Section 9.5, the Interconnection Customer shall not operate its Distributed Energy Resource in parallel with the Area EPS Operator's Distribution System without prior written authorization of the Area EPS Operator.

8 Right of Access

- 8.1. Upon reasonable notice, the Area EPS Operator may send a qualified person to the premises of the Interconnection Customer at or immediately before the time the Distributed Energy Resource first produces energy to inspect the interconnection, and observe the commissioning of the Distributed Energy Resource (including any required testing), startup, and operation for a period of up to three (3) Business Days after initial start-up of the unit. In addition, the Interconnection Customer shall notify the Area EPS Operator at least five (5) Business Days prior to conducting any on-site verification testing of the Distributed Energy Resource.
- 8.2. Following the initial inspection process described above, at reasonable hours, and upon reasonable notice, or at any time without notice in the event of an emergency or hazardous condition, the Area EPS Operator shall have access to the Interconnection Customer's premises for any reasonable purpose in connection with the performance

of the obligations imposed on it by this Agreement or if necessary to meet its legal obligation to provide service to its customers.

- 8.3. Each Party shall be responsible for its costs associated with the interconnection of the DER system as outlined in MIP Process Overview Section 9.3 and the Minnesota Technical Requirements.

9 Term and Termination

- 9.1. This Agreement shall become effective as of the date when both the Interconnection Customer and the Area EPS Operator have both signed this Agreement. The Agreement shall continue in full force and effect until the earliest date that one of the following events occurs:
 - 9.1.1. The Parties agree in writing to terminate the Agreement;
 - 9.1.2. The Interconnection Customer may terminate this Agreement at any time by giving the Area EPS Operator twenty (20) Business Days written notice;
 - 9.1.3. The Area EPS Operator may terminate this Agreement if the Distributed Energy Resource is not interconnected to the Area EPS Operator's Distribution System within thirty-six (36) months of the effective date of this Agreement as set forth above in Section 9.1;
 - 9.1.4. Either Party may terminate this Agreement after default pursuant to Section 19.
- 9.2. No termination shall become effective until the Parties have complied with all Applicable Laws and Regulations applicable to such termination.
- 9.3. Upon termination of this Agreement, the Distributed Energy Resource will be disconnected from the Area EPS Operator's Distribution System. All costs required to effectuate such disconnection shall be borne by the terminating Party, unless such termination resulted from the non-terminating Party's default of this Agreement or such non-terminating Party otherwise is responsible for these costs under this Agreement.
- 9.4. The termination of this Agreement shall not relieve either Party of its liabilities and obligations, owed or continuing, at the time of the termination.
- 9.5. The provisions of this Section 9 shall survive termination or expiration of this Agreement.

10 Disconnection

- 10.1. Disconnection of Unit. The Area EPS Operator may disconnect the Distributed Energy Resource as reasonably necessary, including for the following conditions or situations: termination of this Agreement, non-compliance with this Agreement, a system emergency, imminent danger to the public or Area EPS personnel, or for routine maintenance, repairs, and modifications to the Area EPS. The Area EPS Operator shall use Reasonable Efforts to notify the Interconnection Customer promptly when it becomes aware of an event or condition that may reasonably be expected to affect the Interconnection Customer's operation of the Distributed Energy Resource. The Interconnection Customer shall use Reasonable Efforts to notify the Area EPS Operator promptly when it becomes aware of an event or condition that may reasonably be expected to affect the Area EPS Operator's Distribution System or any Affected Systems. To the extent information is known, the notification shall describe the event or condition, the extent of the damage or deficiency, the expected effect on the operation of both Parties' facilities and operations, its anticipated duration, and the necessary corrective action. It is agreed that the Area EPS Operator shall have no liability for any loss of sales or other damages including all consequential damages for the loss of business opportunity, profits or other losses, regardless of whether such damages were foreseeable, due to the disconnection of the Distributed Energy Resource.
- 10.2. Temporary Interruption. The Area EPS Operator may interrupt interconnection service or curtail the output of the Distributed Energy Resource and temporarily disconnect the Distributed Energy Resource from the Area EPS Operator's Distribution System when necessary for routine maintenance, construction, or repairs on the Area EPS Operator's Distribution System. The Area EPS Operator shall use Reasonable Efforts to provide the Interconnection Customer with three (3) Business Days' notice prior to such interruption. The Area EPS Operator shall use Reasonable Efforts to coordinate such reduction or temporary disconnection with the Interconnection Customer. Temporary disconnection shall continue only for so long as reasonably necessary under Good Utility Practice.
- 10.3. Forced Outage. During any forced outage, the Area EPS Operator may suspend interconnection service to effect immediate repairs on the Area EPS Operator's Distribution System. The Area EPS Operator shall use Reasonable Efforts to provide the Interconnection Customer with prior notice. If prior notice is not reasonably possible, the Area EPS Operator shall, upon request, provide the Interconnection Customer written documentation after the fact explaining the circumstances of the disconnection.

- 10.4. Adverse Operating Effects. The Area EPS Operator shall notify the Interconnection Customer as soon as practicable if, based on Good Utility Practice, operation of the Distributed Energy Resource may cause disruption or deterioration of service to other customers served from the same electric system, or if operating the Distributed Energy Resource could cause damage to the Area EPS Operator's Distribution System or Affected Systems. Supporting documentation used to reach the decision to disconnect shall be provided to the Interconnection Customer upon request. If, after notice, the Interconnection Customer fails to remedy the adverse operating effect within a reasonable time, the Area EPS Operator may disconnect the Distributed Energy Resource. The Area EPS Operator shall provide the Interconnection Customer with five (5) Business Days' notice of such disconnection, unless the provisions of Section 10.1 apply.
- 10.5. Modification of the Distributed Energy Resource. The Interconnection Customer must receive written authorization from the Area EPS Operator before making any change to the Distributed Energy Resource that may have a material impact on the safety or reliability of the Distribution System. Such authorization shall not be unreasonably withheld if the modification is not a Material Modification. Material Modifications, including an increase Nameplate Rating or capacity, may require the Interconnection Customer to submit a new Interconnection Application as described in Section 7 of the MIP Process Overview. If the Interconnection Customer makes such modification without the Area EPS Operator's prior written authorization, the Area EPS Operator shall have the right to temporarily disconnect the Distributed Energy Resource.
- 10.6. Reconnection. The Parties shall cooperate with each other to restore the Distributed Energy Resource, Interconnection Facilities, and the Area EPS Operator's Distribution System to their normal operating state as soon as reasonably practicable following a temporary disconnection.
- 10.7. Treatment Similar to Other Retail Customers. If the Interconnection Customer receives retail electrical service at the same site as the Distributed Energy Resource, it may also be disconnected consistent with the rules and practices for disconnecting other retail electrical customers.
- 10.8. Disconnection for Default. If the Interconnection Customer is in default of this Agreement, it may be disconnected after a sixty (60) day written notice is provided and the default is not cured during this sixty (60) day notice. This provision does not apply to disconnection based on Sections 10.1, 10.2, 10.3 or 10.4 of this Agreement.

11 Cost Responsibility for Interconnection Facilities and Distribution Upgrades

- 11.1 Interconnection Facilities. The Interconnection Customer shall pay for the actual cost of the Interconnection Facilities itemized in Attachment 2 of this Agreement. The Area EPS Operator shall provide a good faith estimate of the cost, including overheads, for the purchase and construction of its Interconnection Facilities and provide a detailed itemization of such costs. Costs associated with Interconnection Facilities may be shared with other entities that may benefit from such facilities by agreement of the Interconnection Customer, such other entities, and the Area EPS Operator.
- 11.2 The Interconnection Customer shall be responsible for its share of all reasonable expenses, including overheads, associated with (1) owning, operating, maintaining, repairing, and replacing its own Interconnection Facilities, and (2) operating, maintaining, repairing, and replacing the Area EPS Operator's Interconnection Facilities.
- 11.3 Distribution Upgrades. The Area EPS Operator shall design, procure, construct, install, and own the Distribution Upgrades described in Attachment 7 of this Agreement. The Area EPS Operator shall provide a good faith estimate of the cost, including overheads, for the purchase and construction of the Distribution Upgrades and provide a detailed itemization of such costs. If the Area EPS Operator and the Interconnection Customer agree, the Interconnection Customer may construct Distribution Upgrades that are located on land owned by the Interconnection Customer. The actual cost of the Distribution Upgrades, including overheads, shall be directly assigned to the Interconnection Customer.

12 Cost Responsibility for Network Upgrades

- 12.1. Applicability. No portion of Section 12 shall apply unless the interconnection of the Distributed Energy Resource requires Network Upgrades.
- 12.2. Network Upgrades. The Area EPS Operator or the Transmission Owner shall design, procure, construct, install, and own the Network Upgrades described in Attachment 7 of this Agreement. The Area EPS Operator shall provide a good faith estimate of the cost, including overheads, for the purchase and construction of the Network Upgrades and provide a detailed itemization of such costs. If the Area EPS Operator and the Interconnection Customer agree, the Interconnection Customer may construct Network Upgrades that are located on land owned by the Interconnection Customer. Unless the Area EPS Operator elects to pay for Network Upgrades, the actual cost of the Network Upgrades, including overheads, shall be borne initially by the Interconnection Customer.

- 12.3. Repayment of Amounts Advanced for Network Upgrades. The Interconnection Customer shall be entitled to a cash repayment, equal to the total amount paid to the Area EPS Operator and Affected System operator, if any, for Network Upgrades, including any tax gross-up or other tax-related payments associated with the Network Upgrades, and not otherwise refunded to the Interconnection Customer, to be paid to the Interconnection Customer on a dollar-for-dollar basis for the non-usage sensitive portion of transmission charges, as payments are made under the Area EPS Operator's Tariff and Affected System's Tariff for transmission services with respect to the Distributed Energy Resource. Any repayment shall include interest calculated in accordance with the methodology set forth in the Federal Energy Regulatory Commission's (FERC) regulations at 18 C.F.R. § 35.19a(a)(2)(iii) from the date of any payment for Network Upgrades through the date on which the Interconnection Customer receives a repayment of such payment pursuant to this subparagraph. The Interconnection Customer may assign such repayment rights to any person.
- 12.4. Notwithstanding the foregoing, the Interconnection Customer, the Area EPS Operator, and any applicable Affected System operators may adopt any alternative payment schedule that is mutually agreeable so long as the Area EPS Operator and said Affected System operators take one of the following actions no later than five years from the Commercial Operation Date: (1) return to the Interconnection Customer any amounts advanced for Network Upgrades not previously repaid, or (2) declare in writing that the Area EPS Operator or any applicable Affected System operators will continue to provide payments to the Interconnection Customer on a dollar-for-dollar basis for the non-usage sensitive portion of transmission charges, or develop an alternative schedule that is mutually agreeable and provides for the return of all amounts advanced for Network Upgrades not previously repaid; however, full reimbursement shall not extend beyond 20 years from the commercial operation date.
- 12.5. If the Distributed Energy Resource fails to achieve commercial operation, but it or another Distributed Energy Resource is later constructed and requires use of the Network Upgrades, the Area EPS Operator and Affected System operator shall at that time reimburse the Interconnection Customer for the amounts advanced for the Network Upgrades. Before any such reimbursement can occur, the Interconnection Customer, or the entity that ultimately constructs the Distributed Energy Resource, if different, is responsible for identifying the entity to which reimbursement must be made.
- 12.6. Special Provisions for Affected Systems. Unless the Area EPS Operator provides, under this Agreement, for the repayment of amounts advanced to any applicable Affected System operators for Network Upgrades, the Interconnection Customer and Affected

System operator shall enter into an agreement that provides for such repayment. The agreement shall specify the terms governing payments to be made by the Interconnection Customer to Affected System operator as well as the repayment by Affected System Operator.

- 12.7. Rights Under Other Agreements. Notwithstanding any other provision of this Agreement, nothing herein shall be construed as relinquishing or foreclosing any rights, including but not limited to firm transmission rights, capacity rights, transmission congestion rights, or transmission credits, that the Interconnection Customer shall be entitled to, now or in the future, under any other agreement or tariff as a result of, or otherwise associated with, the transmission capacity, if any, created by the Network Upgrades, including the right to obtain cash reimbursements or transmission credits for transmission service that is not associated with the Distributed Energy Resource.

13 Billing, Payment, Milestones, and Financial Security

- 13.1. Billing and Payment Procedures and Final Accounting. The Area EPS Operator shall bill the Interconnection Customer for the design, engineering, construction, and procurement costs of Interconnection Facilities and Upgrades contemplated by this Agreement, and the Interconnection Customer shall pay each bill, pursuant to the MIP Interconnection Process documents, or as otherwise agreed to by the Parties.
- 13.2. Within 80 Business Days (approximately 4 calendar months) of completing the construction and installation of the Area EPS Operator's Interconnection Facilities and/or Upgrades described in the Attachments to this Agreement, the Area EPS Operator shall provide the Interconnection Customer with a final accounting report, as described in the MIP Fast Track Process Section 9.5.3 and the Study Process Section 11.4.3.
- 13.3. Milestones. Pursuant to the MIP Fast Track Process Section 9.1 and the Study Process Section 11.1, the Parties shall agree on milestones for which each Party is responsible and list them in Attachment 4 of this Agreement.
- 13.4. Financial Security Arrangements. Pursuant to the MIP Fast Track Process Section 9.6 and the Study Process Section 11.5, the Interconnection Customer shall provide the Area EPS Operator, at the Interconnection Customer's option, a guarantee, letter of credit or other form of security that is reasonably acceptable to the Area EPS Operator and is consistent with the Minnesota Uniform Commercial Code. Such security for payment shall be in an amount sufficient to cover the costs for constructing, designing, procuring, and installing the applicable portion of the Area EPS Operator's Interconnection Facilities and Upgrades and shall be reduced on a dollar-for-dollar

basis for payments made to the Area EPS Operator under this Agreement during its term. In addition:

- 13.4.1. The guarantee must be made by an entity that meets the creditworthiness requirements of the Area EPS Operator, and contain terms and conditions that guarantee payment of any amount that may be due from the Interconnection Customer, up to an agreed-to maximum amount.
- 13.4.2. The letter of credit must be issued by a financial institution or insurer reasonably acceptable to the Area EPS Operator and must specify a reasonable expiration not sooner than sixty (60) Business Days (three calendar months) after the due date for the issuance of the final bill.

14 Assignment

- 14.1. The Interconnection Customer shall not assign its rights nor delegate its duties under this Agreement without the prior written consent of the Area EPS Operator. Any assignment or delegation made by the Interconnection Customer without the Area EPS Operator's written consent shall not be valid. The Area EPS Operator shall not unreasonably withhold its consent to the Interconnection Customer's assignment or delegation under this Agreement.

15 Limitations of Liability

- 15.1. Each Party's liability to the other Party for failure to perform its obligations under this Agreement shall be limited to the amount of direct damage actually incurred. In no event shall either Party be liable to the other Party for any indirect, special, consequential, or punitive damages of any kind whatsoever, including for loss of business opportunity or profits, regardless of whether such damages were foreseen.
- 15.2. Notwithstanding any other provision in this Agreement, with respect to the Area EPS Operator's provision of electric service to any customer including the Interconnection Customer, the Area EPS Operator's liability to such customer shall be limited as set forth in the Area EPS Operator's tariffs and terms and conditions for electric service, and shall not be affected by the terms of this Agreement.

16 Non-Warranty

- 16.1. The Area EPS Operator does not give any warranty, expressed or implied, as to the adequacy, safety, or other characteristics of any structures, equipment, wires, appliances or devices owned, installed or maintained by the Interconnection Customer or leased by the Interconnection Customer from third parties, including without

limitation, the Distributed Energy Resource and any structures, equipment, wires, appliances or devices not owned, operated or maintained by the Area EPS Operator.

17 Indemnity

- 17.1. This provision protects each Party from liability incurred to third parties as a result of carrying out the provisions of this Agreement. Liability under this provision is exempt from the general limitations on liability found in Section 15.
- 17.2. Each Party shall at all times indemnify, defend, and hold the other Party harmless from any and all damages, losses, claims, including claims and actions relating to injury or death of any person or damage to property, demand, suits, recoveries, costs and expenses, court costs, reasonable attorney fees, and all other obligations by or to third parties, arising out of or resulting from the Party's action or failure to meet its obligations under this Agreement, except to the extent that such damages, losses or claims were caused by the negligence or intentional acts of the other Party.
- 17.3. If an indemnified Party is entitled to indemnification under this article as a result of a claim by a third party, and the indemnifying Party fails, after notice and reasonable opportunity to proceed under this article, to assume the defense of such claim, such indemnified Party may at the expense of the indemnifying Party contest, settle or consent to the entry of any judgment with respect to, or pay in full, such claim.
- 17.4. If an indemnifying Party is obligated to indemnify and hold any indemnified Party harmless under this article, the amount owing to the indemnified Party shall be the amount of such indemnified Party's actual loss, net of any insurance or other recovery.
- 17.5. Promptly after receipt by an indemnified Party of any claim or notice of the commencement of any action, administrative or legal proceeding, or investigation as to which the indemnity provided for in this article may apply, the indemnified Party shall notify the indemnifying Party of such fact. Any failure of or delay in such notification shall not affect a Party's indemnification obligation unless such failure or delay is materially prejudicial to the indemnifying Party.

18 Force Majeure

- 18.1. If a Force Majeure Event prevents a Party from fulfilling any obligations under this Agreement, the Party affected by the Force Majeure Event (Affected Party) shall promptly notify the other Party, either in writing or via the telephone, of the existence of the Force Majeure Event. The notification must specify in reasonable detail the circumstances of the Force Majeure Event, its expected duration, and the steps that the Affected Party is taking to mitigate the effects of the event on its performance. The

Affected Party shall keep the other Party informed on a continuing basis of developments relating to the Force Majeure Event until the event ends. The Affected Party will be entitled to suspend or modify its performance of obligations under this Agreement (other than the obligation to make payments) only to the extent that the effect of the Force Majeure Event cannot be mitigated by the use of Reasonable Efforts. The Affected Party will use Reasonable Efforts to resume its performance of obligations under this Agreement as soon as possible.

19 Default

- 19.1. No default of any obligation under this Agreement shall exist where such failure to discharge an obligation (other than the payment of money) is the result of a Force Majeure Event as defined in this Agreement or the result of an act or omission of the other Party. Upon a default, the non-defaulting Party shall give written notice of such default to the defaulting Party. Except as provided in Section 18, the defaulting Party shall have sixty (60) calendar days from receipt of the default notice within which to cure such default; provided however, if such default is not capable of cure within sixty (60) calendar days, the defaulting Party shall commence such cure within twenty (20) calendar days after notice and continuously and diligently complete such cure within six (6) months from receipt of the default notice; and, if cured within such time, the default specified in such notice shall cease to exist.
- 19.2. If a default is not cured as provided in this Section 19, or if a default is not capable of being cured within the period provided for herein, the non-defaulting Party shall have the right to terminate this Agreement by written notice at any time until cure occurs, and be relieved of any further obligation hereunder and, whether or not that Party terminates this Agreement, to recover from the defaulting Party all amounts due hereunder, plus all other damages and remedies to which it is entitled at law or in equity. The provisions of this Section 19 will survive termination of this Agreement.

20 Insurance

- 20.1. An Area EPS Operator may only require an Interconnection Customer to purchase insurance covering damages pursuant to the applicable MIP process document to which the Distributed Energy Resource is subject to.
- 20.2. The Area EPS Operator agrees to maintain general liability insurance or self-insurance consistent with the Area EPS Operator's commercial practice. Such insurance or self-insurance shall not exclude coverage for the Area EPS Operator's liabilities undertaken pursuant to this Agreement.

- 20.3. The Parties further agree to notify each other whenever an accident or incident occurs resulting in any injuries or damages that are included within the scope of coverage of such insurance, whether or not such coverage is sought.
- 20.4. Failure of the Interconnection Customer or Area EPS Operator to enforce the minimum levels of insurance does not relieve the Interconnection Customer from maintaining such levels of insurance or relieve the Interconnection Customer of any liability.

21 Confidential Information

- 21.1. Each Party shall treat and protect Confidential Information under this Agreement in accordance with the Confidentiality provisions in the MIP Process Overview document Section 12.1.

22 Disputes

- 22.1. The Parties agree to attempt to resolve all disputes arising hereunder promptly, equitably and in a good faith manner. The Parties agree to follow the established dispute resolution policy adopted by the Area EPS Operator.

23 Taxes

- 23.1. The Parties agree to follow all applicable tax laws and regulations, consistent with Internal Revenue Service and any other relevant local, state and federal requirements.
- 23.2. Each Party shall cooperate with the other to maintain the other Party's tax status. It is incumbent on the Party seeking to maintain its tax status to provide formal written notice to the other Party detailing what exact cooperation it is seeking from the other Party well prior to any deadlines by which any such action would need to be taken. Nothing in this Agreement is intended to adversely affect, if applicable, the Area EPS Operator's tax-exempt status with respect to the issuance of bonds including, but not limited to, local furnishing bonds.

24 Miscellaneous

- 24.1. Governing Law, Regulatory Authority, and Rules. This Agreement shall be interpreted, governed, and construed under the laws of the State of Minnesota, without regard to its conflicts of law principles. This Agreement is subject to all Applicable Laws and Regulations. Each Party expressly reserves the right to seek changes in, appeal, or otherwise contest any laws, orders, or regulations of a Governmental Authority.
- 24.2. Amendment. The Parties may amend this Agreement by a written instrument duly executed by both Parties, or under Section 24.11 of this Agreement.

- 24.3. No Third-Party Beneficiaries. This Agreement is not intended to and does not create rights, remedies, or benefits of any character whatsoever in favor of any persons, corporations, associations, or entities other than the Parties, and the obligations herein assumed are solely for the use and benefit of the Parties, their successors in interest and where permitted, their assigns.
- 24.4. Waiver. None of the provisions of this Agreement shall be considered waived by a Party unless such waiver is given in writing. The failure of a Party to insist in any one or more instances upon strict performance of any of the provisions of this Agreement or to take advantage of any of its rights hereunder shall not be construed as a waiver of any such provisions or the relinquishment of any such rights for the future, but the same shall continue and remain in full force and effect.
- 24.5. Entire Agreement. This Agreement, including all attachments, constitutes the entire agreement between the Parties with regard to the interconnection of the Distributed Energy Resource of the Parties at the Point(s) of Common Coupling expressly provided for in this Agreement and supersedes all prior agreements or understandings, whether verbal or written. It is expressly acknowledged that the Parties may have other agreements covering other services not expressly provided for herein, which agreements are unaffected by this Agreement. Each Party also represents that in entering into this Agreement, it has not relied on the promise, inducement, representation, warranty, agreement, or other statement not set forth in this Agreement or in the incorporated attachments.
- 24.6. Multiple Counterparts. This Agreement may be executed in two or more counterparts, each of which is deemed an original but all constitute one and the same instrument.
- 24.7. No Partnership. This Agreement shall not be interpreted or construed to create an association, joint venture, agency relationship, or partnership between the Parties, or to impose any partnership obligation or partnership liability upon either Party. Neither Party shall have any right, power or authority to enter into any agreement or undertaking for, or act on behalf of, or to act as or be an agent or representative of, or to otherwise bind, the other Party.
- 24.8. Severability. If any provision or portion of this Agreement shall for any reason be held or adjudged to be invalid or illegal or unenforceable by any court of competent jurisdiction or other Governmental Authority, (1) such portion or provision shall be deemed separate and independent, (2) the Parties shall negotiate in good faith to restore insofar as practicable the benefits to each Party that were affected by such ruling, and (3) the remainder of this Agreement shall remain in full force and effect.

24.9. Environmental Releases. Each Party shall notify the other Party, first orally and then in writing, of the release of any hazardous substances, any asbestos or lead abatement activities, or any type of remediation activities related to the Distributed Energy Resource or the Interconnection Facilities, each of which may reasonably be expected to affect the other Party. The notifying Party shall (1) provide the notice as soon as practicable, provided such Party makes a good faith effort to provide the notice no later than 24 hours after such Party becomes aware of the occurrence, and (2) promptly furnish to the other Party copies of any publicly available reports filed with any governmental authorities addressing such events.

24.10. Subcontractors. Nothing in this Agreement shall prevent a Party from utilizing the services of any subcontractor as it deems appropriate to perform its obligations under this Agreement. Each Party shall require its subcontractors to comply with all applicable terms and conditions of this Agreement in providing such services and each Party shall remain primarily liable to the other Party for the performance of such subcontractor.

24.10.1. The creation of any subcontract relationship shall not relieve the hiring Party of any of its obligations under this Agreement. The hiring Party shall be fully responsible to the other Party for the acts or omissions of any subcontractor the hiring Party hires as if no subcontract had been made. In no event shall the Area EPS Operator be liable for the actions or inactions of the Interconnection Customer or its subcontractors with respect to obligations of the Interconnection Customer under this Agreement. Any applicable obligation imposed by this Agreement upon the hiring Party shall be equally binding upon, and shall be construed as having application to, any subcontractor of such Party.

24.10.2. The obligations under this Section 24 will not be limited in any way by any limitation of subcontractor's insurance.

24.11. Inclusion of Area EPS Operator Tariff and Rules. The interconnection services provided under this Agreement shall at all times be subject to the terms and conditions set forth in the rate schedules and rules applicable to the electric service provided by the Area EPS Operator, which rate schedules and rules are hereby incorporated into this Agreement by this reference. Notwithstanding any other provisions of this Agreement, the Area EPS Operator shall have the right to unilaterally change its rates, charges, classification, service, tariff, or rule, or any agreement relating thereto subject to standard municipal procedures as determined by the appropriate governing board.

25 Notices

- 25.1. General. Unless otherwise provided in this Agreement, any written notice, demand, or request required or authorized in connection with this Agreement (“Notice”) shall be deemed properly given if delivered in person or sent by United States Mail, first class, postage prepaid, to the person specified as follows:

Area EPS Operator Information

Area EPS Operator:

Attention:

Address:

Phone:

Email:

Interconnection Customer Information

Interconnection Customer:

Attention:

Address:

Phone:

Email:

- 25.2. Billing and Payment. Billing and payments shall be sent to the addresses set out below:

Area EPS Operator Information

Area EPS Operator:

Attention:

Address:

Phone:

Email:

Interconnection Customer Information

Interconnection Customer: _____
Attention: _____
Address: _____

Phone: _____
Email: _____

25.3. Alternative Forms of Notice. Any notice or request required or permitted to be given by either Party to the other and not required by this Agreement to be given in writing may be so given by telephone or email to the telephone numbers and e-mail addresses set out below:

Area EPS Operator Information

Area EPS Operator: _____
Attention: _____
Address: _____

Phone: _____
Email: _____

Interconnection Customer Information

Interconnection Customer: _____
Attention: _____
Address: _____

Phone: _____
Email: _____

25.4. Designated Operating Representative. The Parties may also designate operating representatives to conduct the communications which may be necessary or convenient for the administration of this Agreement. This person will also serve as the point of contact with respect to operations and maintenance of the Party’s facilities.

Area EPS Operator Information

Area EPS Operator:

Attention:

Address:

Phone:

Email:

Interconnection Customer Information

Interconnection Customer:

Attention:

Address:

Phone:

Email:

- 25.5. Changes to Notification. Either Party may change this information by giving five Business Days written notice to the other Party prior to the effective date of the change.

26 Signatures

IN WITNESS THEREOF, the Parties have caused this Agreement to be duly executed by their duly authorized officers or agents on the day and year first above written.

[Insert name of Area EPS Operator]

[Insert name of Interconnection Customer]

Signed: _____

Signed: _____

Name (Printed):

Name (Printed):

Title: _____

Title: _____

Attachment I: Glossary of Terms

Affected System – Another Area EPS Operator’s System, Transmission Owner’s Transmission System, or Transmission System connected generation which may be affected by the proposed interconnection.

Applicant Agent – A person designated in writing by the Interconnection Customer to represent or provide information to the Area EPS on the Interconnection Customer’s behalf throughout the interconnection process.

Area EPS – The electric power distribution system connected at the Point of Common Coupling.

Area EPS Operator – An entity that owns, controls, or operates the electric power distribution systems that are used for the provision of electric service in Minnesota. For this Interconnection Process the Area EPS Operator is [NAME OF UTILITY]

Business Day – Monday through Friday, excluding Holidays as defined by Minn. Stat. §645.44, Subdivision 5. Any communication to have been sent or received after 4:30 p.m. Central Prevailing Time or on a Saturday, Sunday or holiday shall be considered to have been sent on the next Business Day.

Certified Equipment – Certified equipment is equipment that has been tested by a national recognized lab meeting a specific standard. For DER systems, UL 1741 listing is a common form of DER inverter certification. Additional information is seen in the Certification Codes and Standards document.

Confidential Information – Any confidential and/or proprietary information provided by one Party to the other Party and is clearly marked or otherwise designated “Confidential.” All procedures, design, operating specifications, and metering data provided by the Interconnection Customer may be deemed Confidential Information. See MIP Process Overview Section 12.1 for further information.

Distributed Energy Resource (DER) – A source of electric power that is not directly connected to a bulk power system or central station service. DER includes both generators and energy storage technologies capable of exporting active power to an EPS. An interconnection system or a supplemental DER device that is necessary for compliance with this standard is part of a DER. For the purpose of the Interconnection Process and interconnection agreements, the DER includes the Customer’s Interconnection Facilities but shall not include the Area EPS Operator’s Interconnection Facilities.

Distribution System – The Area EPS facilities which are not part of the Local EPS, Transmission System or any generation system.

Distribution Upgrades – The additions, modifications, and upgrades to the Distribution System at or beyond the Point of Common Coupling to facilitate interconnection of the DER and render

the distribution service necessary to affect the Interconnection Customer's connection to the Distribution System. Distribution Upgrades do not include Interconnection Facilities.

Electric Power System (EPS) – The facilities that deliver electric power to a load.

Fast Track Process – The procedure as described in the Interconnection Process - Fast Track Process for evaluating an Interconnection Application for a DER that meets the eligibility requirements in the MIP Process Overview Section 3.4.

Force Majeure Event – An act of God, labor disturbance, act of the public enemy, war, insurrection, riot, fire, storm or flood, explosion, breakage or accident to machinery or equipment, an order, regulation or restriction imposed by governmental, military or lawfully established civilian authorities, or another cause beyond a Party's control. A Force Majeure Event does not include an act of negligence or intentional wrongdoing.

Good Utility Practice – Any of the practices, methods and acts engaged in or approved by a significant portion of the electric industry during the relevant time period, or any of the practices, methods and act which, in the exercise of reasonable judgment in light of the facts known at the time the decision was made, could have been expected to accomplish the desired result at a reasonable cost consistent with good business practices, reliability, safety and expedition. Good Utility Practice is not intended to be limited to the optimum practice, method, or act to the exclusion of all others, but rather to be acceptable practices, methods, or acts generally accepted in the region.

Governmental Authority – Any federal, state, local or other governmental regulatory or administrative agency, court, commission, department, board, or other governmental subdivision, legislature, rulemaking board, tribunal, or other governmental authority having jurisdiction over the Parties, their respective facilities, or the respective services they provide, and exercising or entitled to exercise any administrative, executive, police, or taxing authority or power; provided, however, that such term does not include the Interconnection Customer, the Area EPS Operator, or any Affiliate thereof. The utility's local governing body is the authority governing interconnection requirements unless otherwise provided for in the Minnesota Technical Requirements.

Interconnection Agreement – The terms and conditions between the Area EPS Operator and Interconnection Customer (Parties). See Section 8 in the MIP Process Overview for when the MN Standard Agreement or MN Interconnection Agreement applies.

Interconnection Application – The Interconnection Customer's request to interconnect a new or modified, as described in Section 4 of the MIP Process Overview, DER. See Simplified Application Form and Interconnection Application Form.

Interconnection Customer – The person or entity, including the Area EPS Operator, whom will be the owner of the DER that proposes to interconnect a DER(s) with the Area EPS Operator's

Distribution System. The Interconnection Customer is responsible for ensuring the DER(s) is designed, operated and maintained in compliance with the Minnesota Technical Requirements.

Interconnection Facilities – The Area EPS Operator’s Interconnection Facilities and the Interconnection Customer’s Interconnection Facilities. Collectively, Interconnection Facilities include all facilities and equipment between the DER and the Point of Common Coupling, including any modification, additions or upgrades that are necessary to physically and electrically interconnect the DER to the Area EPS Operator’s System. Some examples of Customer Interconnection Facilities include: supplemental DER devices, inverters, and associated wiring and cables up to the Point of DER Connection. Some examples of Area EPS Operator Interconnection Facilities include sole use facilities; such as, line extensions, controls, relays, switches, breakers, transformers and shall not include Distribution Upgrades or Network Upgrades.

Interconnection Process – The Area EPS Operator’s interconnection standards as part of the DG Workbook - MN.

Material Modification – A modification to machine data, equipment configuration or to the interconnection site of the DER at any time after receiving notification by the Area EPS Operator of a complete Interconnection Application that has a material impact on the cost, timing, or design of any Interconnection Facilities or Upgrades, or a material impact on the cost, timing or design of any Interconnection Application with a later Queue Position or the safety or reliability of the Area EPS.¹

Minnesota Technical Requirements – This term refers to the Technical Specifications Manual adopted by the Area EPS Operator (Chapter 8 of the DG Workbook – MN) and the Minnesota Technical Interconnection and Interoperability Requirements approved by the Minnesota Public Utilities Commission in Docket No. E-999/CI-16-521.

Nameplate Rating - nominal voltage (V), current (A), maximum active power (kWac), apparent power (kVA), and reactive power (kVar) at which a DER is capable of sustained operation. For a

¹ A Material Modification shall include, but may not be limited to, a modification from the approved Interconnection Application that: (1) changes the physical location of the point of common coupling; such that it is likely to have an impact on technical review; (2) increases the nameplate rating or output characteristics of the Distributed Energy Resource; (3) changes or replaces generating equipment, such as generator(s), inverter(s), transformers, relaying, controls, etc., and substitutes equipment that is not like-kind substitution in certification, size, ratings, impedances, efficiencies or capabilities of the equipment; (4) changes transformer connection(s) or grounding; and/or (5) changes to a certified inverter with different specifications or different inverter control settings or configuration. A Material Modification shall not include a modification from the approved Interconnection Application that: (1) changes the ownership of a Distributed Energy Resource; (2) changes the address of the Distributed Energy Resource, so long as the physical point of common coupling remains the same; (3) changes or replaces generating equipment such as generator(s), inverter(s), solar panel(s), transformers, relaying, controls, etc. and substitutes equipment that is a like-kind substitution in certification, size, ratings, impedances, efficiencies or capabilities of the equipment; and/or (4) increases the DC/AC ratio but does not increase the maximum AC output capability of the Distributed Energy Resource in a way that is likely to have an impact on technical review.

Local EPS with multiple DER units, the aggregate nameplate rating is equal to the sum of all DERs nameplate rating in the Local EPS. For purposes of Attachment V to the Interconnection Agreement, the DER system’s capacity may, with the Area EPS’s agreement, be limited through use of control systems, power relays or similar device settings or adjustments as identified in IEEE 1547. The nameplate ratings referenced in the Interconnection Process are alternating current nameplate DER ratings at the Point of DER Coupling.

Network Upgrades – Additions, modifications, and upgrades to the Transmission System required at or beyond the point at which the DER interconnects with the Area EPS Operator’s System to accommodate the interconnection with the DER to the Area EPS Operator’s System. Network Upgrades do not include Distribution Upgrades.

Operating Requirements – Any operating and technical requirements that may be applicable due to the Transmission Provider’s technical requirements or Minnesota Technical Requirements, including those set forth in the Interconnection Agreement.

Party or Parties – The Area EPS Operator and the Interconnection Customer.

Point of Common Coupling (PCC) – The point where the Interconnection Facilities connect with the Area EPS Operator’s Distribution System. See figure 1. Equivalent, in most cases, to “service point” as specified by the Area EPS Operator and described in the National Electrical Code and the National Electrical Safety Code.

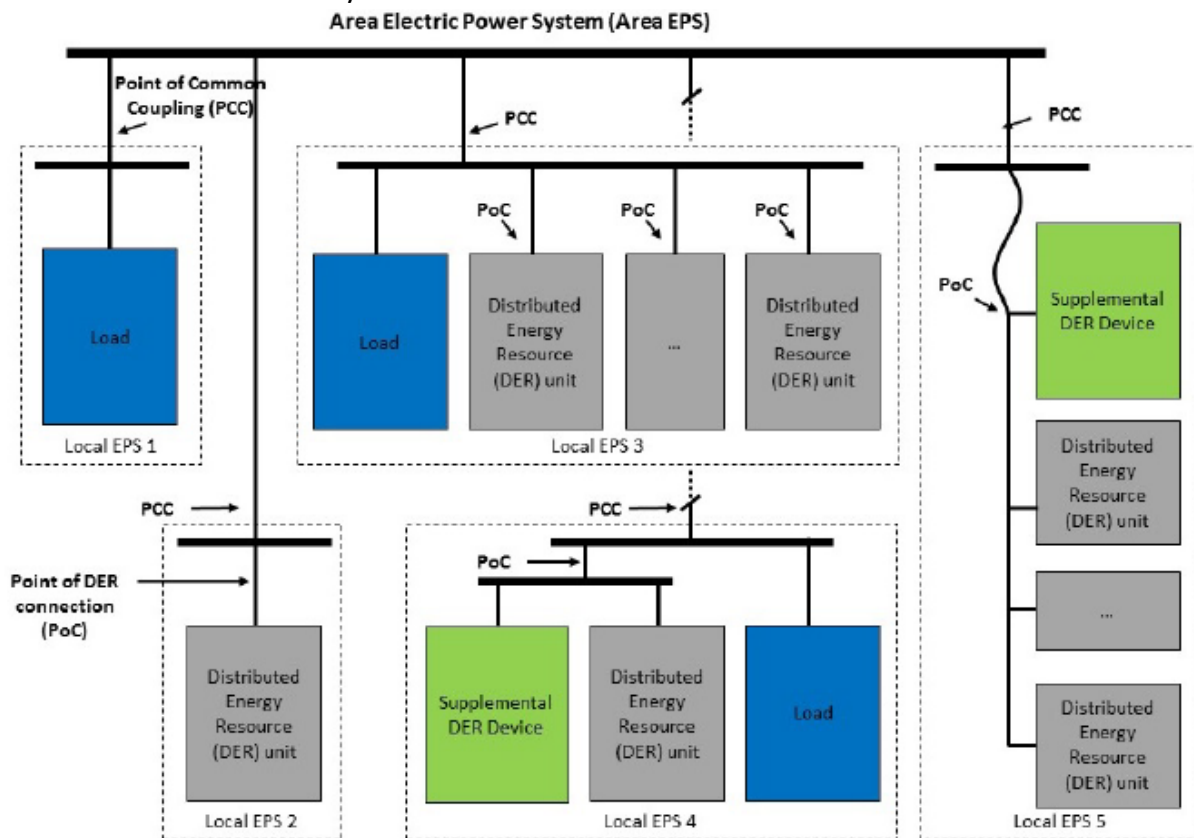

Figure 1: Point of Common Coupling and Point of DER Connection
 (Source: IEEE 1547)

Point of DER Connection (PoC) – When identified as the Reference Point of Applicability, the point where an individual DER is electrically connected in a Local EPS and meets the requirements of this standard exclusive of any load present in the respective part of the Local EPS (e.g. terminals of the inverter when no supplemental DER device is required.) For DER unit(s) that are not self-sufficient to meet the requirements without a supplemental DER device(s), the Point of DER Connection is the point where the requirements of this standard are met by DER in conjunction with a supplemental DER device(s) exclusive of any load present in the respective part of the Local EPS.

Queue Position – The order of a valid Interconnection Application, relative to all other pending valid Interconnection Applications, that is established based upon the date- and time- of receipt of the complete Interconnection Application as described in Section 4.7 of the MIP Process Overview.

Reasonable Efforts – With respect to an action required to be attempted or taken by a Party under these procedures, efforts that are timely and consistent with Good Utility Practice and are otherwise substantially equivalent to those a Party would use to protect its own interests.

Reference Point of Applicability – The location, either the Point of Common Coupling or the Point of DER Connection, where the interconnection and interoperability performance requirements specified in IEEE 1547 apply. With mutual agreement, the Area EPS Operator and Customer may determine a point between the Point of Common Coupling and Point of DER Connection. See Minnesota Technical Requirements for more information.

Simplified Process – The procedure for evaluating an Interconnection Application for a certified inverter-based DER no larger than 20 kW that uses the screens described in the Interconnection Process – Simplified Process document. The Simplified Process includes simplified procedures.

Study Process – The procedure for evaluating an Interconnection Application that includes the scoping meeting, system impact study, and facilities study.

Transmission Owner – The entity that owns, leases or otherwise possesses an interest in the portion of the Transmission System relevant to the Interconnection.

Transmission Provider – The entity (or its designated agent) that owns, leases, controls, or operates transmission facilities used for the transmission of electricity. The term Transmission Provider includes the Transmission Owner when the Transmission Owner is separate from the Transmission Provider. The Transmission Provider may include the Independent System Operator or Regional Transmission Operator.

Transmission System – The facilities owned, leased, controlled or operated by the Transmission Provider or the Transmission Owner that are used to provide transmission service. See the Minnesota Public Utilities Commission’s July 26, 2000 Order Adopting Boundary Guidelines for Distinguishing Transmission from Generation and Distribution Assets in Docket No. E-999/CI-99-1261.

MN Standard Agreement – the Area EPS Operator’s Interconnection and Power Purchase Agreement that may be applied to all qualifying new and existing interconnections between the Area EPS Operator and an DER system having capacity of 100 kW or less.

Upgrades – The required additions and modifications to the Area EPS Operator’s Transmission or Distribution System at or beyond the Point of Interconnection. Upgrades may be Network Upgrades or Distribution Upgrades. Upgrades do not include Interconnection Facilities.

Attachment II: Description and Costs of the Distributed Energy Resource, Interconnection Facilities, and Metering Equipment

Equipment, including the Distribution Energy Resource, Interconnection Facilities, and metering equipment shall be itemized and identified as being owned by the Interconnection Customer or the Area EPS Operator. The Area EPS Operator will provide a good faith estimate itemized cost, including administrative overheads, of its Interconnection Facilities and metering equipment, and a good faith estimate itemized cost of the annual operation and maintenance expenses associated with the Interconnection Facilities and metering equipment.

Attachment III: One-line Diagram Depicting the Distributed Energy Resource, Interconnection Facilities, and Metering Equipment, and Upgrades

Attach the one-line diagram of the Distributed Energy Resource, Interconnection Facilities, Metering Equipment, and Upgrades to which this Agreement applies.

Attachment IV: Milestones

The Milestones in line (1) below may be a calendar date. All other dates in this Attachment IV may be the number of Business Days from the calendar date in line (1) or from the completion of a different Milestone described in a specific number line. Similarly, the anticipated In-Service Date may be based on the number of Business Days from the completion of a specified line number.

In-Service Date: _____

Critical milestones and responsibilities as agreed to by the Parties:

	Milestone/Anticipated Date	Responsible Party
(1)	_____	_____
(2)	_____	_____
(3)	_____	_____
(4)	_____	_____
(5)	_____	_____
(6)	_____	_____
(7)	_____	_____
(8)	_____	_____
(9)	_____	_____
(10)	_____	_____
(11)	_____	_____
(12)	_____	_____
(13)	_____	_____

Agreed to by:

Area EPS Operator _____ Date _____

Transmission Owner
(If Applicable) _____ Date _____

Interconnection
Customer _____ Date _____

Attachment V: Operating Agreement

The Area EPS Operator shall also provide requirements that must be met by the Interconnection Customer prior to initiating parallel operation with the Area EPS Operator's Distribution System. Each Distributed Energy Resource interconnection will be unique and will require a unique Operating Agreement. The following is a listing of some of the possible areas that will be covered in an operating agreement. The following has not been developed into a standard agreement due to the unique nature of each Distributed Energy Resource. It is envisioned that this Attachment will be tailored by the Area EPS Operator for each Distributed Energy Resource interconnection. It is also intended that this Operating Agreement Attachment will be reviewed and updated periodically to allow the operation of the Distributed Energy Resource to change to meet the needs of both the Area EPS Operator and the Interconnection Customer. There may also be operating changes required by outside parties or influences, such as changes in FERC and regional transmission organization requirements and/or policy changes which will require this Operating Agreement to be modified.

The following items are provided to show the general types of items that may be included in this Operating Agreement. The list of items is not all-inclusive and is not meant to preclude any other issues that may be addressed in the Operating Agreement.

- A. Applicable Area EPS Tariffs – Identify which tariffs are being applied for and how the tariffs would be applicable to this installation.
- B. Var Requirements – Sufficient power factor correction and control devices shall be furnished on the Distributed Energy Resource system such that a 98% power factor, minimum, is maintained across the point of interconnection at all times. Sufficient power factor correction and control devices shall be furnished on the Distributed Energy Resource system to provide the capability of unity power factor across the point of interconnection when operating at full generation output capacity. The Distributed Energy Resource shall be set up to attempt to maintain unity power factor at all times during operation.
- C. Metering Arrangement
 - 1. The project will be adequately metered, with metering that is approved by the Area EPS Operator. The meter will be a bi-directional meter capable of metering the energy and power coming from the Distributed Energy Resource or capable of being furnished to the generator. The project and the Interconnection Customer will comply with the standards set out in the MN Interconnection Process.
 - 2. The Area EPS Operator shall provide Missouri River Energy Services (MRES) metering data for inadvertent energy received by the Area EPS on the Area EPS Operator's monthly billing cycle. The metering data shall be made available to MRES no later than ten days after the end of the monthly billing cycle. The Area EPS Operator shall test the

metering equipment on a scheduled basis. If the metering equipment fails to register proper amounts or the registration thereof becomes so erratic as to be meaningless, the inadvertent energy shall be determined by the Area EPS Operator from the best information available.

- D. Inadvertent Energy – MRES shall purchase all inadvertent energy supplied by the Distributed Energy Resource which is received by the Area EPS. The rate paid by MRES for the inadvertent energy will be equal to the commensurate real-time hourly locational marginal price (LMP) as settled by the Midcontinent Independent System Operator (MISO) or Southwest Power Pool (SPP) for the commercial pricing node [*identify node*] located at or near to [*name of local utility*], for the hours during which inadvertent energy was received by the Area EPS, less any administrative costs charged by MISO, SPP or other utilities with respect to the sale or transfer of such energy. The Interconnection Customer acknowledges and agrees that the hourly LMP rate fluctuates based upon the supply and demand for energy within the MISO or SPP market as determined by MISO or SPP, and that it is possible that the LMP price at times may be negative, meaning that the Interconnection Customer may have to make (rather than receive) payment for inadvertent energy received by the Area EPS. The Interconnection Customer shall receive payment for the inadvertent energy to MRES through a credit on the Interconnection Customer's monthly invoice from the Area EPS Operator. MRES, in turn, shall credit the monthly wholesale power supply bill submitted by MRES to the Area EPS Operator in an amount equal to the purchases of inadvertent energy during the preceding month. The Area EPS Operator shall provide to MRES, as soon as available following the end of each month, data indicating the amount of inadvertent energy purchased by MRES from the Interconnection Customer's generation during the preceding month.
- E. Control Issues – Starting and stopping of the generation, including the remote starting and stopping, if applicable.
- F. Dispatch of Distributed Energy Resources – What are the dispatch requirements for the Distributed Energy Resource; can it only run during Peak Hours? Are there a limited number of hours that it can run? Is it required to meet an availability percentage? The answer to these questions will depend greatly upon the PPA and other requirements. Is the Interconnection Customer required to coordinate outages of the Distributed Energy Resource with the Area EPS? Prior to any planned outage and following an unplanned outage, the Area EPS and MRES shall be notified in a timely manner.
- G. Outages of Distribution System – How are emergency outages handled? How are other outages scheduled? If the Interconnection Customer requires the Area EPS Operator to schedule the outages during after-hours, who pays for the Area EPS Operator's overtime?
- H. Notification/Contacts – Who should be notified? How should they be notified? When should they be notified? For what reasons should the notification take place?

1. Starting of the generation
 2. Dispatching of generation
 3. Notification of failures (both Area EPS and Distributed Energy Resource failures)
- I. Documentation of Operational Settings – How much fuel will the generation system typically have on hand? How long can it run with this fuel capacity? How is the generation system set to operate for a power failure? These may be issues documented in the Operating Agreement. The following are examples of what may be documented:
1. The Distributed Energy Resource will monitor the Area EPS phase voltage and after 2 seconds of any phase voltage below 90%, the generation will be started and the load transferred to the generator, if the generation is not already running.
 2. The Distributed Energy Resource will wait for 30 minutes after it senses the return of the Area EPS frequency and voltage before it will automatically reconnect to the Area EPS.
- J. Cost of Testing for Future Failures – If a failure of a component of the Distributed Energy Resource affects the interconnection with the Area EPS, what is the process for retesting, and for replacement? Who pays for the additional costs of the Area EPS to work with the Interconnection Customer to resolve these problems and/or to complete retesting of the modified equipment?
- K. Right of Access – At all times, the Area EPS Operator shall have access to the disconnect switch of the Distributed Energy Resource for any reasonable purpose in connection with the performance of the obligations imposed on it by this Agreement, to meet its obligation to operate the Area EPS safely, and to provide service to its customers. If necessary for the purpose of this Agreement, the Interconnection Customer shall allow the Area EPS Operator access to the Area EPS's equipment and facilities located on the premises.
- L. Power Quality – The installation shall be constructed and operated to ensure that the Area EPS Operator's Distribution System is not adversely affected by power quality issues which may be caused by the Distributed Energy Resource, including voltage flicker. The Distributed Energy Resource shall be equipped with devices which serve to minimize power quality disturbances, including soft starting controls to minimize inrush currents and control devices to prevent multiple units from starting simultaneously.

SIGNATURES

IN WITNESS WHEREOF, the Parties hereto have caused three originals of this Agreement to be executed by their duly authorized representatives. This Agreement is effective as of the last date set forth below.

Interconnection Customer

By: _____

Name: _____

Title: _____

Date: _____

Area EPS Operator

By: _____

Name: _____

Title: _____

Date: _____

Missouri River Energy Services

By: _____

Name: _____

Title: _____

Date: _____

Attachment VI: Maintenance Agreement

Each Distributed Energy Resource interconnection will be unique and will require a unique Maintenance Agreement. This Maintenance Agreement will be tailored for each Distributed Energy Resource interconnection. It is also intended that this Maintenance Agreement will be reviewed and updated periodically to allow changes to meet the needs of both the Area EPS Operator and the Interconnection Customer (provided the change does not negatively affect the other Party). There may also be changes required by outside parties and influences such as changes in FERC or MISO/SPP requirements and/or policies which will require this Agreement to be modified.

- A. Routine Maintenance Requirements
 - 1. Who is providing maintenance – Contact information
 - 2. Periods of maintenance

- B. Modifications to the Distributed Energy Resource – The Interconnection Customer shall notify the Area EPS Operator, in writing, of plans for any modifications to the Distributed Energy Resource interconnection equipment at least twenty (20) business days prior to undertaking such modification. Modifications to any of the interconnection equipment, including all required protective systems, the generation control systems, the transfer switches/breakers, VTs & CTs, generating capacity, and associated wiring, shall be included in the notification to the Area EPS Operator. The Interconnection Customer agrees not to commence installation of any modifications to the Distributed Energy Resource until the Area EPS Operator has approved the modification in writing. The Area EPS shall have ten (10) business days to review and respond to the modification after receipt of the information required for review of the modifications.

SIGNATURES

IN WITNESS WHEREOF, the Parties hereto have caused two originals of this Agreement to be executed by their duly authorized representatives. This Agreement is effective as of the last date set forth below.

Interconnection Customer

Area EPS Operator

By: _____

By: _____

Name: _____

Name: _____

Title: _____

Title: _____

Date: _____

Date: _____

Attachment VII: Area EPS Operator’s Description of Distribution and Network Upgrades and Good Faith Estimates of Upgrade Costs

The Area EPS Operator shall describe Distribution and Network Upgrades and provide an itemized good faith estimate of the costs, including administrative overheads, of the Upgrade and annual operations and maintenance expenses associated with such Upgrades. The Area EPS Operator shall functionalize Upgrade costs and annual expenses as either transmission or distribution related. Additional Distribution or Network Upgrades required for an Affected System may be addressed in a separate agreement as described in Section 12.6 of the MN Interconnection Agreement.

Attachment VIII: Assignment of Interconnection Agreement

This Assignment of Interconnection Agreement (“Assignment”) is made and entered into this ____ day of _____, _____, by and between _____, a municipal utility existing under the laws of the State of Minnesota (“Area EPS Operator”), _____ (“Assignor”), and _____ (“Assignee”).

WHEREAS, the Area EPS Operator and Assignor previously entered into an Interconnection Agreement (“Agreement”) dated as of _____, _____, including any and all Attachments and amendments thereto, for a Distributed Energy Resource (DER) described as follows:

DER System Information

Type of DER System: _____
Capacity Rating of System (AC): _____
Limited Capacity Rating (AC): _____
Address of DER System: _____

WHEREAS, the Assignor intends to convey its interest in the above-referenced DER to the Assignee, and the Assignor intends to assign its rights and obligations under the Agreement to the Assignee.

NOW THEREFORE, in consideration of the mutual undertakings herein contained, the Assignor, the Assignee, and the Area EPS Operator agree as follows:

- 1. Capitalized Terms.** Capitalized terms used but not defined herein shall have the meanings set forth in the Agreement.
- 2. Consent to Assignment.** The Assignor hereby irrevocably assigns the Agreement in all respects to the Assignee and the Assignee accepts the assignment thereof in all respects.
- 3. Amendment to Agreement.** The Area EPS Operator consents to this assignment and, as assigned, the Agreement is hereby amended so that wherever the name of the Assignor

is used therein it shall mean the Assignee. It is further agreed that all terms and conditions of the Agreement, as amended by this Assignment, shall remain in full force and effect.

- 4. **Payments by Area EPS Operator.** Any and all payments made by Area EPS Operator under the Agreement to either the Assignor or the Assignee shall be deemed to have been made to both and shall discharge the Area EPS Operator from any further liability with regard to said payment.

- 5. **Financial Obligations of Assignor and Assignee.** Any and all financial liability, including but not limited to amounts due, from the Interconnection Customer to the Area EPS Operator, occurring or accruing under the Agreement on or before the date of the signature of the Area EPS Operator to this Assignment shall be deemed to be the obligation of both the Assignor and Assignee, and the Area EPS Operator may recover any such amounts jointly and severally from the Assignor and Assignee.

- 6. **Contact information.** The following information updates and replaces the designated information as set forth on page 1 of the Agreement, and in Section 25.1, 25.2, 25.3 and 25.4 of the Agreement.

Page 1 Interconnection Customer Information

Interconnection Customer: _____
Attention: _____
Address: _____

Phone: _____
Email: _____

25.1 General Notices. Interconnection Customer Information

Interconnection Customer: _____
Attention: _____
Address: _____

Phone: _____
Email: _____

25.2 Billing and Payment Notices. Interconnection Customer Information

Interconnection Customer: _____
Attention: _____
Address: _____

Phone: _____
Email: _____

25.3 Alternative Forms of Notices. Interconnection Customer Information

Interconnection Customer: _____
Attention: _____
Address: _____

Phone: _____
Email: _____

25.4 Designated Operating Representative. Interconnection Customer Information

Interconnection Customer: _____
Attention: _____
Address: _____

Phone: _____
Email: _____

7. Signatures. Facsimile or electronic signatures, or signatures to this Assignment sent electronically, shall have the same effect as original signatures. Photocopies, or electronically stored versions of this Assignment, shall have the same validity as the original.

The Area EPS Operator, Assignor, and Assignee have executed this Assignment as of the dates set forth below.

Assignor

[Insert legal name of Assignor]

Signed: _____

Name (Printed): _____

Title: _____

Date: _____

Assignee

[Insert legal name of Assignee]

Signed: _____

Name (Printed): _____

Title: _____

Date: _____

Area EPS Operator

[Insert legal name of Area EPS Operator]

Signed: _____

Name (Printed): _____

Title: _____

Date: _____

Supplemental Review Offer

The Distributed Energy Resource (DER) Interconnection Application in the name of _____ (Interconnection Customer) for a DER system described as _____ (*insert description of DER System*) _____ and proposed to be located at _____ (*insert Address or Legal Description*) _____ has failed one or more of the initial engineering screens. To continue with the Interconnection Process, the Interconnection Customer may choose to continue with a Supplemental Review under the Fast Track Process or may choose the Interconnection Application to be evaluated under the Study Process track. The Interconnection Customer has fifteen (15) Business Days to return this Supplemental Review Offer to the Area Electric Power Supply (EPS or Area EPS) Operator, indicating its choice for the next step in the Interconnection Process. If this Supplemental Review Offer is not returned to the Area EPS Operator within such time period, the Interconnection Application will only continue to be evaluated under the Study Process track or it may be withdrawn by the Interconnection Customer.

Interconnection Customer agrees that the Area EPS Operator shall:

- _____ Proceed with a Supplemental Review of the Interconnection Application under the Fast Track Process.
- _____ Continue evaluation of the Interconnection Application under the Study Process track.
- _____ Deem the Interconnection Application withdrawn.

If the Interconnection Customer chooses to proceed with the Supplemental Review, the Interconnection Customer shall note the order in which the Supplemental Review screens should be performed and indicate the action the Area EPS Operator should take if a Supplemental Review screen has failed.

Supplemental Review Screen	Order to Perform Screens	Cost Estimate of Review Screen
Minimum Load		
Voltage & Power Quality		
Safety & Reliability		
Total Deposit Required		

Upon failure of a Supplemental Review screen or upon notification the Area EPS Operator is unable to complete a Supplemental Review screen, the Interconnection Customer agrees that the Area EPS Operator shall:

- _____ Proceed with the remaining Supplemental Review screens.
- _____ Stop the Supplemental Review screens and continue evaluation of the Interconnection Application under the Study Process track.
- _____ Stop the Supplemental Review screens and contact the Interconnection Customer for further instructions.
- _____ Deem the Interconnection Application withdrawn.

The Area EPS Operator has indicated a good faith estimate of the cost for each Supplemental Review screen. The Interconnection Customer must submit a deposit for the full estimate of Supplemental Review costs prior to the start of any Supplemental Review. Upon completion of the Supplemental Review or termination of the Supplemental Review by the Interconnection Customer, the balance of the actual Supplemental Review costs will be billed or credited to the Interconnection Customer. The balance must be paid in full to the respective party within twenty (20) Business Days of receipt of the final Supplemental Review invoice from the Area EPS Operator.

The Area EPS Operator will have thirty (30) Business Days to complete the Supplemental Review upon receipt of a signed copy of this Supplemental Review Offer and the required deposit. The Area EPS Operator will provide the Interconnection Customer with a written report indicating the Supplemental Review results and the underlying analysis performed.

The Interconnection Customer agrees to the terms and conditions specified in this Supplemental Review Offer and in the Fast Track Process document. The Interconnection Customer understands the Supplemental Review screens will not start until the deposit is received by the Area EPS Operator.

Interconnection Customer Signature

Date

For Office Use Only	
Application ID:	
Date Offer Received:	Date Deposit Received:
Date Supplement Review Results Provided to Interconnection Customer:	

INTERCONNECTION PROCESS

MN System Impact Study Agreement

SUMMARY

Agreement outlining the scope, timeline and responsibility of cost for a proposed DER's system impact to the distribution system

MN System Impact Study Agreement

This MN System Impact Study Agreement (“Agreement”) is made and entered into this _____ day of _____, 20__ by and between _____ (“Interconnection Customer”), and _____, a municipal utility existing under the laws of the State of Minnesota (“Area EPS Operator”). The Interconnection Customer and Area EPS Operator each may be referred to as a “Party,” or collectively as the “Parties.”

RECITALS

WHEREAS, the Interconnection Customer is proposing to develop a Distributed Energy Resource (DER) or generating capacity addition to an existing DER consistent with the Interconnection Application completed by the Interconnection Customer on _____ (date); and

WHEREAS, the Interconnection Customer desires to interconnect the DER with the Area EPS Operator’s electric system; and

WHEREAS, the Interconnection Customer has requested the Area EPS Operator to perform a System Impact Study to assess the impact of interconnecting the DER with the Area EPS Operator’s electric system, and potential Affected System(s);

NOW, THEREFORE, in consideration of and subject to the mutual covenants contained herein, the Parties agree as follows:

1. When used in this Agreement, with initial capitalization, the terms specified shall have the meanings indicated, or the meanings specified, in the MN Interconnection Process Overview (MIP).
2. The Interconnection Customer elects and the Area EPS Operator shall cause to be performed a MN System Impact Study consistent with the MIP. The scope of a MN System Impact Study shall be subject to the assumptions set forth in this Agreement, including Attachment A.
3. A MN System Impact Study will be based upon the technical information provided by the Interconnection Customer in the MN Interconnection Application. The Area EPS Operator reserves the right to request additional technical information from the

Interconnection Customer as may reasonably become necessary consistent with Good Utility Practice during the course of the MN System Impact Study.

4. A MN System Impact Study may, as necessary, consist of a short circuit analysis, a stability analysis, a power flow analysis, voltage drop and flicker studies, protection and set point coordination studies, and grounding reviews. A MN System Impact Study shall state the assumptions upon which it is based, state the results of the analyses, and provide the requirement or potential impediments to providing the requested interconnection service, including a preliminary indication of the cost and length of time that would be necessary to correct any problems identified in those analyses and implement the interconnection. A MN System Impact Study shall provide a list of facilities that are required as a result of the MN Interconnection Application and non-binding good faith estimates of cost responsibility and time to construct. A MN Facilities Study may be required to identify all possibilities of facility upgrades, cost estimates and estimate of construction time.
5. A distribution MN System Impact Study shall incorporate a distribution load flow study, an analysis of equipment interrupting ratings, protection coordination study, voltage drop and flicker studies, protection and set point coordination studies, grounding reviews, and the impact on electric system operation, as necessary.
6. If the MN System Impact Study determines Affected Systems may be affected, a separate MN Transmission System Impact Study may be required. All Affected Systems shall be afforded an opportunity to review and comment upon a MN System Impact Study that indicates potential adverse system impacts on their electric systems.
7. If the Area EPS Operator uses a queuing procedure for sorting or prioritizing projects and their associated cost responsibilities for any required Network Upgrades, the MN System Impact Study shall consider all Distributed Energy Resources (and with respect to Section 7.3 below, any identified Upgrades associated with such higher queued interconnection) that, on the date the MN System Impact Study is commenced:
 - 7.1. Are directly interconnected with the Area EPS Operator's electric system; or
 - 7.2. Are interconnected with Affected Systems and may have an impact on the proposed interconnection; and
 - 7.3. Have a pending higher queued Interconnection Application to interconnect with the Area EPS Operator's electric system.

8. A deposit equivalent to the good faith estimated cost of a MN System Impact Study shall be required from the Interconnection Customer when the signed Agreement is provided to the Area EPS Operator.
9. Any study fees shall be based on the Area EPS Operator's actual costs and include a summary of professional time. An invoice shall be sent to the Interconnection Customer within twenty (20) Business Days after the study is completed and delivered.
10. The Interconnection Customer must pay any study costs that exceed the deposit without interest, within twenty (20) Business Days, on receipt of the invoice or resolution of any dispute. If the deposit exceeds the invoiced fees, the Area EPS Operator shall refund such excess within twenty (20) Business Days of the invoice without interest.
11. Governing Law, Regulatory Authority, and Rules
The validity, interpretation and enforcement of this Agreement and each of its provisions shall be governed by the laws of the State of Minnesota. This Agreement is subject to all Applicable Laws and Regulations. Each Party expressly reserves the right to seek changes in, appeal, or otherwise contest any laws, orders, or regulations of a Governmental Authority.
12. Amendment
The Parties may amend this Agreement by a written instrument duly executed by both Parties.
13. No Third-Party Beneficiaries
This Agreement is not intended to and does not create rights, remedies, or benefits of any character whatsoever in favor of any persons, corporations, associations, or entities other than the Parties, and the obligations herein assumed are solely for the use and benefit of the Parties, their successors in interest, and where permitted, their assigns.
14. Waiver
 - 14.1. The failure of a Party to this Agreement to insist, on any occasion, upon strict performance of any provision of this Agreement will not be considered a waiver of any obligation, right, or duty of, or imposed upon, such Party.
 - 14.2. Any waiver at any time by either Party of its rights with respect to this Agreement shall not be deemed a continuing waiver or a waiver with respect to any other failure to comply with any other obligation, right, or duty under this Agreement. Termination or default of this Agreement for any reason by the Interconnection Customer shall not constitute a waiver of the Interconnection Customer's legal rights to obtain an interconnection from the Area EPS Operator. Any waiver of this Agreement shall, if requested, be provided in writing.

15. Multiple Counterparts
This Agreement may be executed in two or more counterparts, each of which is deemed an original but all constitute one and the same instrument.
16. No Partnership
This Agreement shall not be interpreted or construed to create an association, joint venture, agency relationship, or partnership between the Parties, or to impose any partnership obligation or partnership liability upon either Party. Neither Party shall have any right, power or authority to enter into any agreement or undertaking for, or act on behalf of, or to act as or be an agent or representative of, or to otherwise bind, the other Party.
17. Severability
If any provision or portion of this Agreement shall for any reason be held or adjudged to be invalid or illegal or unenforceable by any court of competent jurisdiction or other Governmental Authority, (1) such portion or provision shall be deemed separate and independent, (2) the Parties shall negotiate in good faith to restore, insofar as practicable, the benefits to each Party that were affected by such ruling, and (3) the remainder of this Agreement shall remain in full force and effect.
18. Subcontractors
- 18.1. Nothing in this Agreement shall prevent a Party from utilizing the services of any subcontractor as it deems appropriate to perform its obligations under this Agreement; provided, however, that each Party shall require its subcontractors to comply with all applicable terms and conditions of this Agreement in providing such services, and each Party shall remain primarily liable to the other Party for the performance of such subcontractor.
- 18.2. The creation of any subcontract relationship shall not relieve the hiring Party of any of its obligations under this Agreement. The hiring Party shall be fully responsible to the other Party for the acts or omissions of any subcontractor the hiring Party hires, as if no subcontract had been made; provided, however, that in no event shall the Area EPS Operator be liable for the actions or inactions of the Interconnection Customer or its subcontractors with respect to obligations of the Interconnection Customer under this Agreement. Any applicable obligation imposed by this Agreement upon the hiring Party shall be equally binding upon, and shall be construed as having application to, any subcontractor of such Party.
- 18.3. The obligations under this article will not be limited in any way by any limitation of subcontractor's insurance.
19. Inclusion of Area EPS Operator Tariffs and Rules
The interconnection services provided under this Agreement shall at all times be subject to the terms and conditions set forth in the DG Workbook-MN and rules applicable to

the electric service provided by the Area EPS Operator, which are hereby incorporated into this Agreement by this reference. Notwithstanding any other provisions of this Agreement, the Area EPS Operator shall have the right to unilaterally change rates, charges, classification, service, tariff, or rule or any agreement relating thereto. The Interconnection Customer shall have the right to protest any such change through the Area EPS Operator's dispute resolution process, pursuant to the Area EPS Operator's rules and regulations.

IN WITNESS THEREOF, the Parties have caused this Agreement to be duly executed by their duly authorized officers or agents on the day and year first above written.

[Insert Name of Area EPS Operator]

[Insert Name of Interconnection Customer]

(Signature)

(Signature)

(Title)

(Title)

Attachment A

Assumptions Used in Conducting the MN System Impact Study

The MN System Impact Study shall be based upon the following assumptions:

- 1) Designation of Point of Common Coupling and configuration to be studied.
- 2) Designation of alternative Points of DER Interconnection and configuration.

1) and 2) are to be completed by the Interconnection Customer. Other assumptions (attached to this Agreement) are to be provided by the Interconnection Customer and the Area EPS Operator. The Area EPS Operator shall use the Reference Point for Applicability which is either the Point of Common Coupling or the Point(s) of DER Interconnection as described in IEEE 1547.

Additional DER Technical Data Required for MN System Impact Study

If applicable, the Area EPS Operator shall provide a list of any additional technical data that is required to adequately perform the MN System Impact Study. This list of required technical data shall be attached to this Agreement. As indicated in Section 4 of the MN Interconnection Process: Study Process document of the MIP, this information is to be returned with the signed MN System Impact Study Agreement and deposit.

Data to Be Provided by the Area EPS Operator with the MN System Impact Study Agreement

Estimate Cost of System Impact Study	\$
Time duration to complete System Impact Study	Business Days

INTERCONNECTION PROCESS

MN Facilities Study Agreement

SUMMARY

Agreement outlining the scope, timeline and responsibility of cost for a proposed DER system's facility changes to the distribution system

MN Facilities Study Agreement

This MN Facilities Study Agreement (“Agreement”) is made and entered into this ____ day of _____, 20__ by and between _____ (“Interconnection Customer”), and _____, a municipal utility existing under the laws of the State of Minnesota (“Area EPS Operator”). The Interconnection Customer and Area EPS Operator each may be referred to as a “Party,” or collectively as the “Parties.”

RECITALS

WHEREAS, the Interconnection Customer is proposing to develop a Distributed Energy Resource (DER) or generating capacity addition to an existing DER consistent with the Interconnection Application completed by the Interconnection Customer on _____ (date); and

WHEREAS, the Interconnection Customer desires to interconnect the DER with the Area EPS Operator’s Electric System; and

WHEREAS, the Area EPS Operator has completed Initial Review, Supplemental Review, and/or a MN System Impact Study, and provided the results of said review to the Interconnection Customer, or determined none was required; and

WHEREAS, the Interconnection Customer has requested the Area EPS Operator to perform a Facilities Study to specify, and estimate the cost of, the equipment, engineering, procurement and construction work needed to implement the conclusions of the above noted review in accordance with Good Utility Practice, to physically and electrically connect the DER with the Area EPS Operator’s Distribution System.

NOW, THEREFORE, in consideration of and subject to the mutual covenants contained herein, the Parties agree as follows:

1. When used in this Agreement, with initial capitalization, the terms specified shall have the meanings indicated, or the meanings specified, in the MN Interconnection Process Overview (MIP).
2. The Interconnection Customer elects and the Area EPS Operator shall cause a MN Facilities Study to be performed consistent with the MIP. The scope of the MN Facilities Study shall be subject to data provided in Section 17 to this Agreement.
3. The MN Facilities Study shall specify and estimate the cost of the equipment, engineering, procurement and construction work (including overheads), needed to implement the conclusions of the MN System Impact Study(-ies). The MN Facilities Study shall also identify: 1) the electrical switching configuration of the equipment, including, without limitation, transformer, switchgear, meters, and other station equipment, 2) the nature and estimated cost of the Area EPS Operator’s Interconnection Facilities and Upgrades necessary to

accomplish the interconnection, and 3) an estimate of the time required to complete the construction and installation of such facilities.

4. The Area EPS Operator may propose to group facilities required for more than one Interconnection Customer in order to minimize facilities costs through economies of scale. Any interconnection customer may require the installation of facilities required for its own Distributed Energy Resource if they are willing to pay the costs of those facilities.
5. A deposit equivalent to the good faith estimated cost of a distribution MN Facilities Study shall be required from the Interconnection Customer when the signed Agreement is provided to the Area EPS Operator.
6. Any study fees shall be based on the Area EPS Operator's actual costs and include a summary of professional time. An invoice shall be sent to the Interconnection Customer within twenty (20) Business Days after the study is completed and delivered.
7. The Interconnection Customer must pay any study costs that exceed the deposit without interest, within twenty (20) Business Days, on receipt of the invoice or resolution of any dispute. If the deposit exceeds the invoiced fees, the Area EPS Operator shall refund such excess within twenty (20) Business Days of the invoice without interest.

8. Governing Law, Regulatory Authority, and Rules

The validity, interpretation and enforcement of this Agreement and each of its provisions, shall be governed by the laws of the State of Minnesota. This Agreement is subject to all Applicable Laws and Regulations. Each Party expressly reserves the right to seek changes in, appeal, or otherwise contest any laws, orders, or regulations of a Governmental Authority.

9. Amendment

The Parties may amend this Agreement by a written instrument duly executed by both Parties.

10. No Third-Party Beneficiaries

This Agreement is not intended to and does not create rights, remedies, or benefits of any character whatsoever in favor of any persons, corporations, associations, or entities other than the Parties, and the obligations herein assumed are solely for the use and benefit of the Parties, their successors in interest, and where permitted, their assigns.

11. Waiver

- 11.1. The failure of a Party to this Agreement to insist, on any occasion, upon strict performance of any provision of this Agreement will not be considered a waiver of any obligation, right, or duty of, or imposed upon, such Party.
- 11.2. Any waiver at any time by either Party of its rights with respect to this Agreement shall not be deemed a continuing waiver or a waiver with respect to any other failure to comply with any other obligation, right, or duty under this Agreement. Termination or default of this Agreement for any reason by the Interconnection

Customer shall not constitute a waiver of the Interconnection Customer's legal rights to obtain an interconnection from the Area EPS Operator. Any waiver of this Agreement shall, if requested, be provided in writing.

12. Multiple Counterparts

This Agreement may be executed in two or more counterparts, each of which is deemed an original but all constitute one and the same instrument.

13. No Partnership

This Agreement shall not be interpreted or construed to create an association, joint venture, agency relationship, or partnership between the Parties, or to impose any partnership obligation or partnership liability upon either Party. Neither Party shall have any right, power or authority to enter into any agreement or undertaking for, or act on behalf of, or to act as or be an agent or representative of, or to otherwise bind, the other Party.

14. Severability

If any provision or portion of this Agreement shall for any reason be held or adjudged to be invalid or illegal or unenforceable by any court of competent jurisdiction or other Governmental Authority, (1) such portion or provision shall be deemed separate and independent, (2) the Parties shall negotiate in good faith to restore, insofar as practicable, the benefits to each Party that were affected by such ruling, and (3) the remainder of this Agreement shall remain in full force and effect.

15. Subcontractors

15.1. Nothing in this Agreement shall prevent a Party from utilizing the services of any subcontractor as it deems appropriate to perform its obligations under this Agreement; provided, however, that each Party shall require its subcontractors to comply with all applicable terms and conditions of this Agreement in providing such services, and each Party shall remain primarily liable to the other Party for the performance of such subcontractor.

15.2. The creation of any subcontract relationship shall not relieve the hiring Party of any of its obligations under this Agreement. The hiring Party shall be fully responsible to the other Party for the acts or omissions of any subcontractor the hiring Party hires, as if no subcontract had been made; provided, however, that in no event shall the Area EPS Operator be liable for the actions or inactions of the Interconnection Customer or its subcontractors with respect to obligations of the Interconnection Customer under this Agreement. Any applicable obligation imposed by this Agreement upon the hiring Party shall be equally binding upon, and shall be construed as having application to, any subcontractor of such Party.

15.3. The obligations under this article will not be limited in any way by any limitation of subcontractor's insurance.

16. Inclusion of Area EPS Operator Tariffs and Rules

The interconnection services provided under this Agreement, shall at all times, be subject to the terms and conditions set forth in the DG Workbook-MN and rules applicable to the electric service provided by the Area EPS Operator, which are hereby incorporated into this Agreement by this reference. Notwithstanding any other provisions of this Agreement, the Area EPS Operator shall have the right to unilaterally change rates, charges, classification, service, tariff, or rule or any agreement relating thereto. The Interconnection Customer shall have the right to protest any such change through the Area EPS Operator's dispute resolution process, pursuant to the Area EPS Operator's rules and regulations.

17. Data to be Provided by Interconnection Customer with MN Facilities Study Agreement

17.1. The Interconnection Customer shall be available to meet on site with the Area EPS Operator within five (5) Business Days of signing the MN Facilities Study Agreement. The Interconnection Customer's personnel for this site visit shall bring detailed information on the site layout. The Area EPS Operator may request the Interconnection Customer physically place stakes at the locations of major components.

17.2. Upon execution of this Agreement, the Interconnection Customer shall furnish a final site plan to the Area EPS Operator detailing the location of major equipment. The Point of Common Coupling (PCC) and Point of Distributed Resource Connection (PoC) shall be clearly marked. The site plan shall depict any nearby roads and be labeled with the road name. Accurate dimensions shall be included on the site plan. The proper emergency (911) address corresponding to the site shall be labeled on the site plan.

17.3. The Interconnection Customer shall furnish a final one-line diagram detailing the electrical connections between major components. The one-line shall be provided to the Area EPS Operator with the signed MN Facilities Study Agreement.

17.4. The Interconnection Customer shall furnish technical cut sheets on all equipment related to metering. The technical cut sheets shall be provided to the Area EPS Operator with the signed MN Facilities Study Agreement.

17.5. If available, copies of the Conditional Use Permit(s) from all necessary authorities shall be provided by the Interconnection Customer to the Area EPS Operator with the signed MN Facilities Study Agreement.

17.6. The Interconnection Customer shall secure any necessary easements from private land owners prior to signing the MN Facilities Study Agreement. Documentation of any such agreements shall be provided to the Area EPS Operator.

17.7. In the event that the Area EPS Operator determines a site survey is necessary in order to complete a MN Facilities Study, the Interconnection Customer shall make good faith efforts to complete the survey in a timely manner.

17.8. The MN Facilities Study assumes all land use permits required for the interconnection will be approved by the proper authorities. Permits are submitted after the MN Interconnection Agreement is signed and may impact project costs (i.e. overhead to underground requirements.)

17.9. The Interconnection Customer and Area EPS Operator shall provide a single point of contact for design and construction related matters. The Interconnection Customer's single point of contact shall respond in a timely manner to the Area EPS Operator's questions during the MN Facilities Study.

17.10. In the event that the Interconnection Customer does not provide the necessary information described in this Agreement, or if the Interconnection Customer takes more than five (5) Business Days to respond to a question during the MN Facilities Study, the MN Facilities Study timeframe shall pause until the question is resolved.

IN WITNESS THEREOF, the Parties have caused this Agreement to be duly executed by their duly authorized officers or agents on the day and year first above written.

[Insert Name of Area EPS Operator]

[Insert Name of Interconnection Customer]

(Signature)

(Signature)

(Title)

(Title)

Data to Be Provided by the Area EPS Operator with the MN Facilities Study Agreement

Estimate Cost of Facilities Study	\$
Time duration to complete Facilities Study	Business Days

INTERCONNECTION PROCESS

MN Transmission System Impact Study Agreement

SUMMARY

Agreement outlining the scope, timeline and responsibility of cost for a proposed DER system's system impact to the transmission system

MN Transmission System Impact Study Agreement

This MN Transmission System Impact Study Agreement (“Agreement”) is made and entered into this ____ day of _____, 20__ by and between _____ (“Interconnection Customer”), and _____, a municipal utility existing under the laws of the State of Minnesota, (“Area EPS Operator”), and _____, a transmission system owner existing under the laws of the State of Minnesota (“Transmission Provider”). The Interconnection Customer, Area EPS Operator and Transmission Provider each may be referred to as a “Party,” or collectively as the “Parties.”

RECITALS

WHEREAS, the Interconnection Customer is proposing to develop a Distributed Energy Resource or generating capacity addition to an existing DER (in either case referred to herein as a “DER”) interconnected to the Area EPS Operator’s electric system, as described in the Interconnection Application completed by the Interconnection Customer and submitted to the Area EPS Operator on _____; and

WHEREAS, the Interconnection Customer has requested the Area EPS Operator to work with the Transmission Provider to perform a MN Transmission System Impact Study to assess the impact on the Transmission Provider’s electric transmission system of interconnecting the DER with the Area EPS Operator’s electric system, and to determine if there are potential Affected System(s) in addition to the Transmission Provider’s electric transmission system;

NOW, THEREFORE, in consideration of and subject to the mutual covenants contained herein, the Parties agreed as follows:

1. When used in this Agreement, with initial capitalization, the terms specified shall have the meanings indicated, or the meanings specified, in the MN Interconnection Process Overview (MIP).
2. The Interconnection Customer requests and the Area EPS Operator and its Transmission Provider agrees to perform a MN Transmission System Impact Study consistent with the MIP. The Interconnection Customer understands and acknowledges that the Area EPS Operator and the Transmission Provider may perform separate system impact studies. The scope of a MN Transmission System Impact Study shall be subject to the assumptions set forth in this Agreement, including Attachment A.
3. A MN Transmission System Impact Study will be based upon the technical information provided by the Interconnection Customer in the Interconnection Application. Each of the Area EPS Operator and Transmission Provider reserve the right to request additional technical information from the Interconnection Customer as may reasonably become

necessary consistent with Good Utility Practice during the course of the MN Transmission System Impact Study. Neither the Area EPS Operator nor the Transmission Provider will be obligated to commence the MN Transmission System Impact Study until each has received adequate technical information from the Interconnection Customer.

4. In the event that the applicable bulk transmission system generation interconnection process (such as the Midcontinent Independent System Operator or MISO, or Southwest Power Pool or SPP) supersedes the MIP, the Transmission Provider will so notify the Interconnection Customer and this Agreement will be deemed terminated.
5. A MN Transmission System Impact Study may, as determined by the Area EPS Operator and/or the Transmission Provider, consist of a short circuit analysis, a stability analysis, a power flow analysis, voltage analysis and flicker studies, protection and set point coordination studies, and grounding reviews. A MN Transmission System Impact Study shall state the assumptions upon which it is based, indicate the applicable Local Planning Criteria used, state the results of the analyses, and provide the requirement or potential impediments to providing the requested interconnection service, including a preliminary indication of the cost and length of time that would be necessary to correct any problems identified in those analyses and provide for the interconnection. A MN Transmission System Impact Study shall provide a list of transmission facilities that are required as a result of the Interconnection Application and non-binding good faith estimates of cost responsibility and time to construct such transmission facilities. A Facilities Study may be required to identify all possibilities of facility upgrades, cost estimates and estimate of construction time.
6. If the Transmission Provider determines there are any potential Affected System(s), the Affected System(s) will be asked to participate in or review/comment on the MN Transmission System Impact Study. The Affected System(s) will be entitled to determine in their sole discretion the extent of their participation or review/comment, and will be entitled to apply their respective Local Planning Criteria. The Transmission Provider will inform the Interconnection Customer of the estimated cost of the Affected System's participation in or review/comment on the MN Transmission System Impact Study.
7. The MN Transmission System Impact Study will be scheduled for completion taking in consideration for prior-queued projects in the applicable bulk transmission generation interconnection queue or Transmission Provider's generation interconnection queue. The Transmission Provider and/or the Area EPS Operator shall notify the Interconnection Customer if such condition exists.
8. The Area EPS Operator and/or the Transmission Provider shall provide an estimate of the cost of the MN Transmission System Impact Study to the Interconnection Customer. At the time that the Interconnection Customer executes this Agreement, the Interconnection Customer shall provide a deposit of the estimated cost(s) of the MN

Transmission System Impact Study to the Area EPS Operator and/or Transmission Provider, as applicable.

9. The Interconnection Customer shall be responsible for the actual costs incurred by the Area EPS Operator and/or the Transmission Provider to perform the MN Transmission System Impact Study. An invoice documenting the actual costs shall be sent by the Area EPS Operator and/or Transmission Provider to the Interconnection Customer within twenty (20) Business Days after the study is completed and delivered.
10. The Interconnection Customer shall pay the invoice amount less the deposit amount, within twenty (20) Business Days, on receipt of the invoice. If the deposit exceeds the actual cost of the study, the Transmission Provider shall refund such excess amount within twenty (20) Business Days of the date of the invoice.
11. Governing Law, Regulatory Authority, and Rules
The validity, interpretation and enforcement of this Agreement and each of its provisions shall be governed by the laws of the State of Minnesota. This Agreement is subject to all Applicable Laws and Regulations. Each Party expressly reserves the right to seek changes in, appeal, or otherwise contest any laws, orders, or regulations of a Governmental Authority.
12. Amendment
The Parties may amend this Agreement by a written instrument duly executed by both Parties.
13. No Third-Party Beneficiaries
This Agreement is not intended to and does not create rights, remedies, or benefits of any character whatsoever in favor of any persons, corporations, associations, or entities other than the Parties, and the obligations herein assumed are solely for the use and benefit of the Parties, their successors in interest, and where permitted, their assigns.
14. Waiver
 - 14.1. The failure of a Party to this Agreement to insist, on any occasion, upon strict performance of any provision of this Agreement will not be considered a waiver of any obligation, right, or duty of, or imposed upon, such Party.
 - 14.2. Any waiver at any time by either Party of its rights with respect to this Agreement shall not be deemed a continuing waiver or a waiver with respect to any other failure to comply with any other obligation, right, or duty under this Agreement. Termination or default of this Agreement for any reason by the Interconnection Customer shall not constitute a waiver of the Interconnection Customer's legal rights to obtain an interconnection from the Area EPS Operator. Any waiver of this Agreement shall, if requested, be provided in writing.

15. Multiple Counterparts

This Agreement may be executed in two or more counterparts, each of which is deemed an original but all constitute one and the same instrument.

16. No Partnership

This Agreement shall not be interpreted or construed to create an association, joint venture, agency relationship, or partnership between the Parties, or to impose any partnership obligation or partnership liability upon a Party. No Party shall have any right, power or authority to enter into any agreement or undertaking for, or act on behalf of, or to act as or be an agent or representative of, or to otherwise bind, any other Party.

17. Severability

If any provision or portion of this Agreement shall for any reason be held or adjudged to be invalid or illegal or unenforceable by any court of competent jurisdiction or other Governmental Authority, (1) such portion or provision shall be deemed separate and independent, (2) the Parties shall negotiate in good faith to restore, insofar as practicable, the benefits to each Party that were affected by such ruling, and (3) the remainder of this Agreement shall remain in full force and effect.

18. Subcontractors

18.1. Nothing in this Agreement shall prevent a Party from utilizing the services of any subcontractor as it deems appropriate to perform its obligations under this Agreement; provided, however, that each Party shall require its subcontractors to comply with all applicable terms and conditions of this Agreement in providing such services, and each Party shall remain primarily liable to the other Party for the performance of such subcontractor.

18.2. The creation of any subcontract relationship shall not relieve the hiring Party of any of its obligations under this Agreement. The hiring Party shall be fully responsible to the other Parties for the acts or omissions of any subcontractor the hiring Party hires, as if no subcontract had been made; provided, however, that in no event shall the Area EPS Operator or the Transmission Provider be liable for the actions or inactions of the Interconnection Customer or its subcontractors with respect to obligations of the Interconnection Customer under this Agreement. Any applicable obligation imposed by this Agreement upon the hiring Party shall be equally binding upon, and shall be construed as having application to, any subcontractor of such Party.

18.3. The obligations under this article will not be limited in any way by any limitation of subcontractor's insurance.

19. Inclusion of Area EPS Operator Tariffs and Rules

The interconnection services provided under this Agreement, shall at all times, be subject to the terms and conditions set forth in the DG Workbook-MN and rules

applicable to the electric service provided by the Area EPS Operator, which are hereby incorporated into this Agreement by this reference. Notwithstanding any other provisions of this Agreement, the Area EPS Operator shall have the right to unilaterally change rates, charges, classification, service, tariff, or rule or any agreement relating thereto. The Interconnection Customer shall have the right to protest any such change through the Area EPS Operator's dispute resolution process, pursuant to the Area EPS Operator's rules and regulations.

IN WITNESS THEREOF, the Parties have caused this Agreement to be duly executed by their duly authorized officers or agents on the day and year first above written.

[Insert Name of Area EPS Operator]

[Insert Name of Interconnection Customer]

(Signature)

(Signature)

(Title)

(Title)

[Insert Name of Transmission Provider]

(Signature)

(Title)

Attachment A

Assumptions Used in Conducting the MN Transmission System Impact Study

The MN Transmission System Impact Study shall be based upon the following assumptions:

- 1) Designation of Point of Common Coupling and configuration to be studied.
- 2) Designation of alternative Points of DER Interconnection and configuration.

1) and 2) are to be completed by the Interconnection Customer. Other assumptions (attached to this Agreement) are to be provided by the Interconnection Customer, the Area EPS Operator and the Transmission Provider. The Area EPS Operator and Transmission Provider shall use the Reference Point for Applicability which is either the Point of Common Coupling or the Point(s) of DER Interconnection as described in IEEE 1547.

Additional DER Technical Data Required for MN Transmission System Impact Study

If applicable, the Transmission Provider shall attach a list to this Agreement of any additional technical data that is required to adequately perform the MN Transmission System Impact Study. As indicated in Section 5 of the Study Process document of the MIP, this information is to be returned with the signed MN Transmission System Impact Study Agreement and deposit.

Data to Be Provided by the Area EPS Operator and Transmission Provider with the MN Transmission System Impact Study Agreement

Estimate Cost of MN Transmission System Impact Study	\$
Time duration to complete MN Transmission System Impact Study	Business Days

MN DG Workbook Chapter 8

Technical Specifications Manual (TSM) For Minnesota Members [Companion Document to the Minnesota Technical Interconnection and Interoperability Requirements (TIIR)]

For the Interconnection and Operation of Distributed Energy
Resources with the Local Utility Electric System

**Version 2.0
August 2021**

Contents

1	Introduction	1
1.1	General Information	2
2	Abbreviations and Common Terms	5
2.1	Abbreviations	5
2.2	Key Terms	5
3	Performance Category Assignment	7
3.1	Normal – Category A and B	7
3.2	Assignment of Abnormal Performance Category I, II or III	7
4	Reactive Power Capability and Voltage/Power Control Performance	8
4.1	Constant Power Factor Control	8
4.2	Voltage and Active Power Control	8
4.3	Voltage and Reactive Power Control	8
5	Response to Abnormal Conditions	9
5.1	Voltage Ride-Through and Tripping	9
6	Protection Requirements	11
6.1	Utility AC Disconnecting Device	11
6.2	Protection Coordination	12
6.3	Protection Requirements	13
6.4	Grounding	18
7	Operations	20
7.1	Periodical Testing & Record Keeping	20
7.2	O&M Agreements	21
7.3	System Voltage	21
7.4	Power Ramp Rates	22
7.5	Enter Service	22
8	Power Control Systems	24
8.1	General	24

9	Interoperability	27
9.1	Monitoring	27
9.2	Direct Transfer Trip	28
9.3	Security	28
10	Energy Storage Systems (ESS).....	29
10.1	General	29
10.2	Defining Common Modes of Operations	29
10.3	Control System Requirements.....	31
11	Metering Requirements.....	32
11.1	Factors Affecting Metering Requirements	32
11.2	General Requirements	33
11.3	Location and access of metering.....	34
11.4	Main Meter (PCC)	34
11.5	Production Meter (PoC).....	34
11.6	Metering Configurations for Example Residential Use Cases	35
12	Signage and Labeling	36
12.1	General	36
12.2	Utility AC Disconnect.....	36
12.3	Main Meter	36
12.4	Production Meter	36
13	Test and Verification Requirements	38
13.1	Procedure.....	38
13.2	Pre-Interconnection Commissioning Testing: >40 kW Interconnection.....	38
13.3	Final Interconnection Commissioning Testing: >40 kW Interconnection or not with Inverter	40
13.4	Documentation	42
13.5	Failure Protocol	43
13.6	Hardware or Software Changes	43
14	Sample Documents for Simplified Process	45
14.1	One-line diagram.....	45
14.2	Equipment Certification Information	46
14.3	Site diagram	46

Appendix A – Protection and Connection One-line Drawings	48
A-1 Open Transition (Break-Before-Make) Transfer Switch	48
A-2 Closed Transition (Make-before-Break) Transfer Switch	49
A-3 Soft Loading Transfer Switch – with Limited Parallel Operation.....	52
A-4 Soft Loading Transfer Switch – with Extended Parallel Operation	53
A-5 Inverter Connected DER	54
Appendix B – Protective Relaying Elements	55

1 Introduction

This Technical Specifications Manual (TSM) has been developed as a companion document to the Minnesota TIIR (Technical Interconnection and Interoperability Requirements). The TIIR can be located at the Minnesota Public Utilities Commission website. This TSM applies to all Distributed Energy Resources (DER) that are interconnected with the Local Utility electric distribution system. Both the TIIR and TSM documents are based upon the IEEE 1547 standards and other applicable national standards.

This TSM provides specific information about interconnecting a DER with the Local Utility electric distribution system (Area EPS). The TSM applies to DER with an aggregate Nameplate Rating of 10 MW or less at the Point of Common Coupling. The TSM applies to all DER which are capable of paralleling with the Local Utility electric distribution facilities for a brief period, or for extended operation.

The TSM has been written to cover the most common DER interconnection issues, but there will be unique DER interconnections which may require additional interaction between the Local Utility and the proposed DER installer. Prior to purchasing equipment, if the TSM does not provide guidance for a specific type or style of interconnection or if there are questions, it is recommended that the Interconnection Customer contact the Area EPS Operator's DER Interconnection Coordinator. Failure to meet the requirements for interconnection with the municipal electric system may result in disconnection of the interconnection.

It is encouraged that an application for interconnection of a DER is submitted to the Local Utility before ordering the DER equipment to avoid additional costs or delays with the project. Applying for interconnection will trigger a design review by the Local Utility. If this review identifies technical issues with the interconnection location, type or design, it is easier to resolve these issues if the DER equipment has not been ordered.

The IEEE Std 1547, IEEE Standard for Interconnecting Distributed Resources with Electric Power Systems, is the primary standard for interconnection requirements. Other IEEE, ANSI, and NESC requirements are applicable to the interconnection of DER, including energy storage systems. The National Electric Code (NEC) is required to be followed for all electrical equipment installed on the customer's side of the Local Utility meter and all DER installations are required to be inspected by the local area electrical inspector prior to interconnection with the Local Utility system. As required by Minnesota State law, the Area EPS Operator will require proof of compliance with the National Electrical Code before the interconnection is made, through installation approval by an electrical inspector recognized by the Minnesota State Board of Electricity.

The Local Utility has the right to limit the maximum size of any DER and the number of DER systems interconnected if the proposed DER system(s) adversely impacts power quality or reduces the reliability to the other customers connected to the Area EPS. The interconnection of a new DER facility to the municipal electric system

must not degrade the existing utility protection and control schemes nor lower the existing levels of safety and reliability for other customers.

This standard only covers the technical requirements and does not cover the interconnection process from the planning of a project through approval and construction. Please see “Chapter 4: Interconnection Process Overview” of the DG workbook – MN for the procedure to follow and a generic version of the forms to submit.

It is important to understand the Local Utility’s tariffs concerning DER interconnection. Involving the Area EPS Operator’s DER Interconnection Coordinator earlier in the planning and design of the Generation System interconnection will lead to a more efficient and orderly process to interconnect DER systems to the distribution system.

1.1 General Information

1.1.1 Application of IEEE 1547-2018 Standards

The IEEE 1547-2018 standard has been approved and is available for use as the national standard for interconnection and interoperability of DERs with electric power systems. Currently, not all the equipment used to provide DER interconnections has been certified to meet the new IEEE 1547.1-2018 requirements. This is especially true for grid-tie inverters. This document has been written such that the requirements for interconnection are assuming that the equipment being used complies with the IEEE 1547a-2014 requirements.

In some cases, this document also provides guidance to support the use of equipment which can meet the requirements of the new IEEE 1547-2018 standard. As stated in the TIIR: *“At such time certified equipment first becomes available, the Area EPS Operator and the DER Owner may mutually agree to utilize the certified equipment and functionalities in conformance with the requirements of IEEE 1547-2018.”*

1.1.2 References and Definitions

The references and the definitions from the IEEE 1547-2018 and Minnesota TIIR documents are applicable for this document.

Italicized words or sections in this document are direct references to information contained within the TIIR.

1.1.3 Certified Inverter

An inverter is considered certified if it meets the requirements listed in Section 14 of “Chapter 4: Interconnection Process Overview” of the DG Workbook - MN. The most current standard for IEEE 1547 as of the drafting date of this document is the 2018 version and the associated testing procedure IEEE 1547.1-2018 is still under development and not available to the manufacturers to become certified. So, the IEEE 1547a-2014 and the associated IEEE 1547.1a is the most recent version for certification.

Inverters certified to UL 1741-SA are the current available units. The SA stands for Supplement A of the IEEE 1547 series of standards.

1.1.4 DER Installations using Open Transfer Switch

For a DER installation to qualify as an open transition switch installation and the associated limited protective requirements, mechanical interlocks are required between the two source contacts (Area EPS source and DER source). This is required to ensure that one of the contacts is always open and the DER can never be operated in parallel with the Area EPS. If the mechanical interlock is not present, the protection requirements are as if the switch is a closed transition switch that can parallel with the Area EPS. This requirement is due to the possibility that the solenoid operating a source contact can fail and without the mechanical interlock present, parallel the DER with the Area EPS. Open Transition switches, with a mechanical interlock between the source contactors are exempt from submitting an interconnection application to the Area EPS. If there are any questions, please contact the Area EPS Operator’s DER Interconnection Coordinator.

1.1.5 Electric System Modifications

Depending upon the location of the interconnection, size of the DER and how the DER is operated, certain modifications and/or additions may be required to the existing municipal electric system due to the addition of the DER. As part of the application and review process, any modifications required to the municipal electric system will be identified along with the estimated costs which will be incurred by the DER applicant.

1.1.6 Distributed Energy Resource (DER) System Protection

The Interconnection Customer is solely responsible for providing protection for the DER and the public. Protection systems required in this standard are structured to protect equipment and reliability of the Area EPS. The protection for the DER system is not provided for in this standard. Additional protection equipment, beyond what is required within this TSM,

may be required to ensure proper operation of the DER. This is especially true while operating disconnected from the Area EPS. The Area EPS does not assume responsibility for protection of the DER equipment or of any portion of the Local EPS.

1.1.7 Bulk Transmission System Requirements

The TSM document provides the requirements associated with the municipal electric distribution system. This TSM document does not include any of the requirements which may apply due to interaction of the proposed DER and the bulk transmission system. The municipal electric distribution system is interconnected with the bulk transmission system. If the interconnection and operation of the proposed DER affects the transmission system, the Local Utility together with the DER interconnection applicant will need to work with the area transmission provider to identify any additional operational limitations, interconnection limitations or interconnection design requirements that may exist due to transmission constraints.

1.1.8 Aggregation and Coordination of DER Operations at Multiple Sites

Concurrent operation of DER located at multiple sites is not allowed without written permission of the Local Utility. For example, the use of multiple DER systems to provide concurrent load reduction or frequency control that is jointly controlled is not allowed on the municipal electric system without coordination and written approval by the Local Utility.

1.1.9 Design and Maintenance of DER Facilities

The Local Utility's review and approval of the interconnection of the DER generation is not a complete design and operational review of the DER system and does not relieve the Interconnection Customer of its responsibility to design, install, test, operate and maintain the DER generation in a safe manner. The Interconnection Customer is responsible for any damage or injuries resulting from the DER generation system energizing a deenergized portion of the Area EPS or injecting inadvertent energy into the Area EPS which causes equipment damage, injuries or affects the reliable flow of electricity to other Local Utility customers.

2 Abbreviations and Common Terms

2.1 Abbreviations

AGIR	Authority Governing Interconnection Requirements
Area EPS	Area Electrical Power System
BPS	Bulk Power System
DER	Distributed Energy Resource
EPS	Electric Power System
ESS	Energy Storage System
Local EPS	Local Electrical Power System
MN DIA	Minnesota Distributed Energy Resource Interconnection Agreement
MN DIP	Minnesota Distributed Energy Resource Interconnection Process
PoC	Point of Distributed Energy Resource Connection
PCC	Point of Common Coupling
RPA	Reference Point of Applicability
RTO	Regional Transmission Operator
MN DER TIIR	Minnesota Distributed Energy Resource Technical Interconnection and Interoperability Requirements
TPS	Transmission Power System
TSM	Technical Specifications Manual

2.2 Key Terms

The terms used in this document are defined in the MN DER TIIR. For quick reference, the key terms are further explained in this section.

Area Electric Power System (Area EPS): The electric power distribution system connected at the Point of Common Coupling. The Local Utility is the Area EPS for this TSM document, and the term Area EPS and Local Utility are used interchangeably.

Area Electric Power System Operator (Area EPS Operator): An entity that owns, controls, or operates the electric power distribution system that are used for the provision of electric service. The Local Utility is the Area EPS Operator for this TSM document.

DER Interconnection Coordinator: The person or persons designated by the Area EPS Operator to provide a single point of coordination with the Interconnection Customer for the generation interconnection process.

Interconnection Agreement: The terms and conditions between the Area EPS Operator and Interconnection Customer governing the interconnection between the Area EPS and a DER system.

Interconnection Customer: The party or parties who are responsible for meeting the requirements set forth in this document. This could include the DER

system applicant, installer, designer, owner, or operator.

Local Electric Power System (Local EPS): An EPS contained entirely within a single premise or group of premises. The Local EPS is the local electrical system in the house or business.

Point of Common Coupling (PCC): The point of connection between the Area EPS and the Local EPS. For residential services this is the main Local Utility revenue meter. For commercial services this is typically at the secondary of the distribution transformer.

Point of Distributed Energy Resources Connection (PoC): The point where a DER unit is electrically connected in a Local EPS and meets the requirement of the MN DER TIIR and this document exclusive of any load present in the respective part of the Local EPS.

Reference Point of Applicability (RPA): The location where the interconnection and interoperability performance requirements specified in the MN DER TIIR and this document apply. The RPA could be at the PCC or the PoC, or another location which is defined in the operating section of the interconnection agreement.

3 Performance Category Assignment

The Local Utility has no further requirements for performance categories than that provided in the MN DER TIIR. Performance Category Assignment will not be enforced until such time as equipment that is certified to meet the IEEE 1547-2018 standard are readily available. The appropriate regulatory agency will set the cutover date once equipment is available.

Performance criteria outside of those defined in the TIIR will require mutual agreement between the Local Utility and the Interconnection Customer. Should abnormal operating conditions arise as a result of Interconnection Facilities, then mitigation may be required at the expense of the responsible Interconnection Customer.

3.1 Normal – Category A and B

The Local Utility follows the MN DER TIIR for category assignment.

Technology	Normal performance category
Inverter-based DER	Category B
Synchronous machine generation	Category A

3.2 Assignment of Abnormal Performance Category I, II or III

The Local Utility follows the MN DER TIIR for abnormal performance categories.

DER systems which can meet some or all the abnormal performance categories of IEEE 1547-2018 are encouraged to utilize Category I for all synchronous machine DER and Category II for all inverter-based DER.

4 Reactive Power Capability and Voltage/Power Control Performance

The DER must be capable of maintaining a power factor level to help mitigate the impact the DER may have on the Area EPS. This section provides the default and expected capabilities of a DER system on the Area EPS. Unless such operation is reviewed and approved by the Area EPS Operator, the DER must not actively regulate the voltage at the PCC while in parallel with the Area EPS.

4.1 Constant Power Factor Control

The voltage and reactive power control for a DER system will greatly depend on the size and location of the DER within the Area EPS. The Area EPS Operator expects that the DER system will maintain a steady PF at the RPA, and may require additional firm operating requirements in an operating agreement for the DER system. The Interconnection Customer's default settings for power factor control must be as follows:

DER System (kVA AC)	Power Factor	Reactive Power Control
< 40 kVA	0.98	Absorbing Reactive Power
40 kVA to < 250 kVA	0.98	Absorbing Reactive Power
250 kVA to < 1 MVA	0.98*	Absorbing Reactive Power
1 MVA to 10 MVA	0.98*	Absorbing Reactive Power

*DER systems must be capable of being adjusted within the range of 0.95 to 1.0 PF in both the leading (absorbing) and lagging (injecting) directions. The Area EPS Operator has the right to request a more stringent power factor requirement.

During normal operation of the DER system the power factor must never be below 0.90 at the RPA.

4.2 Voltage and Active Power Control

Voltage and Active power control must be disabled unless mutually agreed upon by the Area EPS Operator and the Interconnection Customer.

4.3 Voltage and Reactive Power Control

Volt-Var power control must be disabled unless mutually agreed upon by the Area EPS Operator and the Interconnection Customer.

5 Response to Abnormal Conditions

It is the responsibility of DER systems to respond appropriately to abnormal conditions that may arise on the power system. Until equipment that is certified to meet IEEE 1547-2018 is readily available, it is required that equipment utilized for interconnecting and operating the DER system be certified to meet IEEE 1547a-2014 for response to abnormal conditions. The IEEE 1547-2003 setting profile should be used with the power factor setting adjusted to meet Section 4 of the TSM. The following settings are based upon the IEEE 1547-2003 requirements.

5.1 Voltage Ride-Through and Tripping

5.1.1 Inverter based

The inverter-based DER must trip for abnormal voltages outside of these parameters. The following table lists the required clearing time for the DER system for over and under voltages. If able, the inverter must ride through the disturbance until these values are reached.

Shall Trip – Inverter based DER		
Shall Trip Function	Default Settings	
	Clearing time (s)	Voltage (p.u. of nominal voltage)
UV2	0.16	0.50
UV1	2.0	0.88
OV1	1.0	1.10
OV2	0.16	1.20

5.1.2 All other Technologies (Synchronous Machine Generation)

The synchronous and all other non-inverter based DER must trip for abnormal voltages outside of these parameters. The following table lists the required clearing time for the DER system for over and under voltages. If able, the DER must ride through the disturbance until these values are reached.

Shall Trip – Synchronous DER		
Shall Trip Function	Default Settings	
	Clearing time (s)	Voltage (p.u. of nominal voltage)
UV2	0.16	0.50
UV1	2.0	0.88
OV1	1.0	1.10
OV2	0.16	1.20

5.1.3 Frequency Ride-Through and Tripping

All DER systems must trip for abnormal frequency outside of these parameters. The following table lists the required clearing time for the DER system for over and under frequency. The DER must not trip for frequency issues, if the frequency remains between 59.3 and 60.5 Hz and, if able, must not trip until the frequency is above/below the thresholds for the clearing times indicated.

	Default Settings	
Function	Frequency (Hz)	Clearing Time (s)
UF1	59.3	0.16
OF1	60.5	0.16

5.1.4 Dynamic Voltage Support

Dynamic voltage support by the DER system is not currently allowed. See Section 4 for more information about dynamic voltage support.

6 Protection Requirements

The DER is required to at least have the protective devices that are shown in the Appendix A one-line diagrams. The protective devices are required for the safe and reliable operation of the Area EPS with interconnected DER systems. Only typical DER systems are shown in Appendix A, and the one-line diagrams do not fit all possible DER configurations. The specific protection requirements for interconnection will depend upon the DER's size and type; the number of units; Area EPS configuration and characteristics; the operating modes of the DER; and the location of the proposed DER interconnection on the Local Utility system. The interconnection of a new DER to the electric utility system must not degrade any of the existing utility protection and control schemes nor lower the existing levels of safety and reliability to other customers.

If the DER system utilizes a transfer system, which transfers the customer's load from the Area EPS to the DER generation, and that transfer system has a user accessible selection of several transfer modes, the transfer mode which has the greatest protection requirements will establish the protection requirements for that transfer system.

The Interconnection Customer must provide the required protective devices and systems to detect the Voltage, Frequency, Current, and Harmonic levels as defined in the IEEE 1547 standard during periods when the DER is operated in parallel with the Area EPS. The Interconnection Customer is responsible for the purchase, installation, and maintenance of these devices. This section discusses the requirements for these protective devices and systems.

6.1 Utility AC Disconnecting Device

A Utility AC Disconnect used by the Area EPS Operator and others to safely isolate the DER must be supplied and installed by the Interconnection Customer for DER generation.

6.1.1 Utility AC Disconnect – Requirements

The Utility AC Disconnect must meet the following requirements:

- (1) Manually operated: Able to be operated by one person and designed so that the operator is not exposed to energized components.
- (2) Gang-operated: One switch handle opens and closes all energized conductors simultaneously.
- (3) Neutral conductor may not be interrupted.
- (4) Lockable in the open (off) position with Local Utility padlocks.
- (5) Readily accessible to utility personnel 24/7.
- (6) Provides a visible verification that an air-gap separation exists between the blades and points of contact when open.
- (7) Rated and listed for the application.

- (8) AC-rated device, located on the AC output/utility side of any DER.
- (9) No tools required to loosen or remove hardware or fasteners.
- (10) Labeled in accordance with the requirements of the Local Utility.

The Utility AC Disconnect must be located within 10 feet of the utility revenue (service) meter. If it is not possible to locate the Utility AC Disconnect within 10 feet of the utility meter, written approval by Local Utility for placement of the disconnect in a location which is not within 10 feet of the revenue meter is required. Also, if not located within 10 feet of the revenue meter, a permanently affixed placard meeting NEC requirements must be located at the revenue meter, indicating the disconnect location. The placard must include a mapped representation of the property indicating the location of the disconnect.

6.2 Protection Coordination

Overcurrent protection requirements must meet the NEC requirements for all DER. The first protective device on the DER side of the PCC must coordinate with the Local Utility upstream protective device(s). All DER systems are required to have service protection furnished by the Interconnection Customer immediately after the utility revenue main service meter.

6.2.1 Secondary Services

All secondary voltage electric services are required to install protective devices per the NEC. All DER must be located behind protection meeting this standard. If a supply-side tap is used for DER interconnection, a protective device must immediately follow the tap.

6.2.2 Primary Services

The primary protective device(s) on the Interconnection Customer's side of the revenue meter must coordinate with the Area EPS Operator's protective device(s) located upstream of the revenue meter (PCC), to prevent tripping of utility protective devices for failure of customer-owned equipment. A coordination study must be completed and approved prior to energization.

6.2.3 Coordination with Utility Automatic Reclosing Schemes

Most faults that occur on overhead lines are transient. That is, if the line is de-energized promptly, it can often be quickly re-energized and returned to service. Examples of such transient faults include momentary tree contact due to wind, and insulator flashover due to lightning. Automatic reclosing of overhead lines is a standard industry practice to improve system reliability. In many cases, an overhead line can be de-energized and reclosed within one second, with minimum disruption of service to the customers connected to the line.

In accordance with utility standard practices, most overhead circuits are operated with reclosing enabled to improve reliability and reduce the number of sustained outages. Reclosing on Area EPS lines can potentially damage rotating machines, both synchronous and induction, that are operated in parallel with the EPS.

The Interconnection Customer is responsible for protecting the DER facility's equipment so that automatic or manual reclosing, faults, or other disturbances on the Local Utility system do not cause damage to Local Utility equipment. Addition of DER to a line must not alter the utility's standard auto-restoration schemes. Because of this, some configurations may require direct tripping of connected DER for faults on the Area EPS.

6.3 Protection Requirements

6.3.1 General Relay Information

For all DER systems utilizing certified inverter(s), 250kW and larger and other DER systems greater than 50kW, to be interconnected with the Area EPS, the protective functions and relay settings must be reviewed, tested and approved by a Professional Electrical Engineer registered in the State of Minnesota.

For all DER systems larger than 40kW which utilize inverters for the protective functions, the inverter settings must be provided to the Local Utility for review and approval. For all systems utilizing protective relays, before energization or interconnection of the DER with the Area EPS, a copy of the proposed protective relay settings must be supplied to the Local Utility for review and approval. The review is to ensure proper coordination between the DER and the Area EPS. The documentation must be provided to the Local Utility with enough time to allow for review, coordination, implementation and functional testing of the protective systems, including time to implement any modifications requested by the Area EPS.

The coordination review is not a complete review of the DER protection, and it remains the responsibility of the Interconnection Customer to ensure that there are adequate systems in place to protect the DER and the general public.

Once the protective relay settings have been reviewed and approved by the Area EPS, the Interconnection Customer will complete a functional test of the protective relaying systems including injecting current and voltage into the relays and proving the associated protective breakers and switches will trip.

Use of inverters that are not in compliance with UL 1741 and certified by a Nationally Recognized Testing Laboratory (NRTL) will not be permitted. All

new applications for DER interconnections which use inverters, are required to be certified to UL-1741 SA (Supplement A) or be certified as compliant with IEEE 1547-2018 standard and IEEE 1547.1-2018.

6.3.2 Relaying

All equipment providing relaying functions must meet or exceed all applicable standards, including ANSI/IEEE Standards for protective relays (i.e., C37.90, C37.90.1 and C37.90.2).

Relays required to provide protective functions that are not “draw-out” cased relays, must have test plugs or test switches installed to permit field testing and maintenance of the relay without unwiring or disassembling the equipment. Certified inverters which provide utility required protective functions are excluded from this requirement if the aggregate Nameplate Rating of the DER system is 250kW or less.

Three-phase interconnections must utilize three-phase power relays or multi-phase inverters approved by the Area EPS, which monitor all three phases of voltage and current, unless so noted in the Appendix A one-lines.

All protective relays must have DC power supplies powered by batteries capable of supplying the protective relays for a minimum of 8 hours, to allow remote operation of the interconnection breaker during power outages. See Section 6.3.4 for more information.

All relays must be equipped with setting limit ranges at least as wide as specified in IEEE 1547, and meet other requirements as specified in the Area EPS system impact study. Setting limit ranges are not to be confused with the actual relay settings required for the proper operation of the installation. At a minimum, all protective systems must meet the requirements established in IEEE 1547.

Non-exporting DER systems that operate in parallel with the Area EPS system have the same requirements as that of any other DER interconnection.

6.3.3 Protective Relaying Elements

SUMMARY OF RELAYING REQUIREMENTS								
Type of Interconnection	Over-current (50/51)	Voltage (27/59)	Frequency (81 0/U)	Reverse Power (32)	Lockout (86)	Parallel Limit Timer (62)	Sync-Check (25)	Transfer Trip
Certified Inverter Connected < 250kW (Appendix A Fig. 5)	(1)	(1)	(1)	-	-	-	(1)	-
Certified Inverter Connected >250kW (Appendix A – Fig. 4)	Yes (2)	Yes (2)	Yes (2)	Yes (2)(4)	Yes (2)	Yes (2)	Yes (2)	Yes (3)
Limited Parallel Quick Open Transition (Appendix A - Fig. 2)	-	-	-	-	Yes	Yes	Yes	-
Limited Parallel Closed Transition (Appendix A - Fig. 2)	-	-	-	-	Yes	Yes	Yes	-
Soft Loading Limited Parallel Operation (Appendix A - Fig. 3)	Yes	Yes	Yes	Yes	Yes	Yes	Yes	-
Soft Loading Extended Parallel < 250 kW (Appendix A - Fig. 4)	Yes	Yes	Yes	-	Yes	-	Yes	-
Soft Loading Extended Parallel >250kW (Appendix A - Fig.4)	Yes	Yes	Yes	-	Yes	-	Yes	Yes (3)
Extended Parallel >250kW (Appendix A - Fig.4)	Yes	Yes	Yes	Yes (4)	Yes	-	Yes	Yes (3)

Note 1: Relaying Elements are part of a certified inverter.

Note 2: For inverter-based DER that are 250kW or larger, a breaker with associated relaying is required for interconnection with the Area EPS system.

Note 3: Direct Transfer Trip is required if the Area EPS determines that the proposed DER cannot detect and trip for Area EPS fault within an acceptable time frame, or if the Area EPS determines that the proposed DER cannot detect and trip for the loss of source supply to the Area EPS.

Note 4: For installation where export to the Area EPS is approved the setting of the reverse power relay will be greater than zero or may not be required, coordinate with the Area EPS for reverse power settings.

6.3.4 Power for Protective Devices

All protective relays which require external power to operate must be supplied by a DC battery system that can maintain power to the protective devices for a minimum of 8 hours during a complete power outage. The DC system must include a charging system with alarming for failure of the charger. The battery system must be equipped with a DC-undervoltage detection alarm or be monitored by a 24/7 monitoring facility. In the event of a failure of the DC power supply, the protection scheme will be considered failed and the DER(s) associated with the protective schemes must be quickly and automatically disconnected from the Area EPS system. The DER system must also be blocked from reconnection with the Area EPS system until the DC power to the protective relaying system is re-energized.

For DER larger than 250kW, an analog signal or digital value representative of the real-time DC voltage level must be provided to the Area EPS monitoring system. For systems with an aggregated Nameplate Rating of less than 250kW, if the DC voltage level is not monitored 24/7 there must be an alarming sound or flashing light upon loss of DC battery voltage.

Periodic testing and inspection, in accordance with the manufacturer recommendations of the DC power system (including the batteries and charger) is the responsibility of the Interconnection Customer.

6.3.5 Open Phase Protection

- (1) For non-inverter based DER, or inverter-based DER that opt not to use the onboard protective functions of the inverter for open-phase detection (either due to DER design configurations that render the detection method invalid or any other reason), special consideration must be given to the methodology used to detect and trip for an open phase event.

Typical inverter-based configurations that require additional relaying include:

- Configurations with zig-zag or grounded wye-delta grounding banks
- Configurations with delta windings on step-up transformers

- (2) As required by IEEE 1547, all DER must detect open phase conditions at its RPA when output is as low as 5% of its rated output, or, if not capable of producing apparent power at 5% of its rated output, at the lowest output the DER can continue producing apparent power.

- (3) The Local Utility does not recommend a specific method for detecting an open phase condition, as there are many acceptable methods for achieving this. Positive-sequence phase balance, zero-sequence detection and under voltage relaying are known to be deficient protective schemes and will not be accepted for the purpose of detecting and tripping for an open phase.
 - a. Positive-sequence phase balance and zero-sequence detection must set their pickup levels above the inherent imbalance on the Area EPS to avoid nuisance tripping. This pickup level will often be too high to allow the protective system to identify an open phase condition when the DER is at 5% output.
 - b. Loss of phase via under voltage relaying detection is inadequate for identifying an open phase condition. Ground banks and delta winding, present on both the DER site and on the larger Area EPS, may reconstruct voltage at the open point of the RPA.

6.3.6 Single-phase DER on Multiphase Services

- (1) The aggregate nameplate rating for single-phase DER on a multi-phase system cannot exceed 10% of the distribution transformer rating that is supplying the service.
- (2) When multiple single-phase DER systems connect to a multi-phase service to form a three-phase generation source, the DER must trip off when there is a loss of a single individual phase on the Area EPS, with or without a fault.
- (3) DER systems which are connecting to an existing two-phase Open Delta- Wye or Open Wye-Delta secondary must be single phase or the voltage of the service must be converted to a three phase 120/208 or 277/480 volt system.

6.3.7 Additional Protection Requirements based upon Interconnection Transformer Configuration

The impedance of a dedicated transformer limits fault current on the DER facilities from the Area EPS and limits fault current on the Area EPS from the DER. Hence, it reduces the potential damage to both the Area EPS and the DER due to faults. It also reduces the ability of the Area EPS Operator and Interconnection Customer to identify faults on the other parties' system. As such, a high-side and low side, fault-interrupting device is required for transformer protection. A three-phase circuit breaker is recommended, but fuses may be acceptable for DER systems rated less than 1,000 kW, provided coordination, if required, can be obtained with the existing Area EPS protection equipment. If fuses are used, it is recommended that the

Interconnection Customer install single-phase protection for its equipment.

Interconnection transformers are required to have off-load manual tap changer on their primary (high voltage) side with a minimum range of +/- 2.5% of rated voltage.

(1) Wye-Wye Transformer Connections

Both the Primary and Secondary of the transformer must be grounded. With this transformer connection, the DER is subject to harmonics from the Area EPS and the DER must be designed to limit the harmonic output from the DER system to below the IEEE standard levels.

(2) Open Wye & Open Delta Transformer Connections

No new services utilizing Open-Delta transformer connections are allowed on the Area EPS system. Adding DER to existing Open Wye or Open Delta services will require special coordination with the Area EPS Operator. Due to the nature of the transformer configuration, there will be significant limitations for adding DER to these types of transformation.

(3) Wye-Delta Transformation

Wye side of the transformation is required to be grounded. High side phase voltage monitoring to sense single phase faults on the primary side of the transformer is also required.

Potential issues due to zero sequence injections into the Area EPS from the Grounded Wye winding must be addressed as part of the interconnection design. Design and detailed transformer documentation are required to be provided to the Area EPS Operator for review and approval, to ensure safe and reliable interconnection and overall operation.

Ground source issues for the DER connected to the transformer delta side also need to be addressed.

(4) Delta-Wye or Delta-Delta Transformation

These transformer configurations are not allowed for interconnection of a DER to the Area EPS system.

6.4 Grounding

The DER system must be effectively grounded pursuant to IEEE std. 142 – IEEE Recommend Practice for Grounding of Industrial and Commercial Power Systems. The Area EPS Operator reserves the right at any time to request a report or testing confirming effective grounding. In addition, any studies required to ensure that ground potential rise meets safe levels for step and touch potential must also be submitted together to the Area EPS Operator with the effective grounding report when requested.

6.4.1 Requirement of Grounding Transformers

Grounding transformers may be required for DER systems with an aggregate Nameplate Rating of 250kW or greater. During the application review process the Area EPS Operator will work with the applicant to determine if a grounding transformer is required.

6.4.2 Wye-Wye Interconnections

For Wye-Wye transformer configurations both the primary and secondary side of the transformer must be grounded. The DER must also have an appropriately sized ground bank or the generator's neutral must be adequately grounded.

6.4.3 Wye-Delta Interconnections

For Wye-Delta transformer configurations with the Delta on the DER side, the Wye side is required to be grounded.

The Area EPS Operator requires high-side voltage monitoring to sense loss of phase on the primary side of the transformer. The Interconnection Customer must also plan to address zero sequence injection into the Area EPS from the grounded wye winding.

6.4.4 Delta-Wye and Delta-Delta Interconnections

Delta-Wye and Delta-Delta transformer configurations are not allowed by the Area EPS Operator for DER systems.

7 Operations

7.1 Periodical Testing & Record Keeping

The Interconnection Customer must notify the Area EPS Operator prior to any of the following events occurring:

- *Protection functions are being adjusted after the initial commissioning process.*
- *Functional performance changes of the DER.*
- *Functional software or firmware changes are being made on the DER.*
- *Any hardware component of the DER is being modified in the field or is being replaced or repaired with parts that are not substitutive components compliant with this standard.*
- *Protection settings are being changed after factory testing.*

Prior to modifications to the DER triggering re-verification, the Interconnection Customer must notify the Area EPS Operator's Interconnection Coordinator and provide information about the proposed modification and contact information for whom the Area EPS Operator should interact with about the proposed modification. Any of the above events may be cause for requiring re-verification of the interconnection and interoperability requirements as stated in TIIR Section 14.5.

Since significant equipment damage and liability can result from failures of the DER protective equipment, the Interconnection Customer must ensure that all the DER protective equipment is operating properly. Thus, all interconnection-related protection and control systems must be periodically tested and maintained, by the Interconnection Customer, at intervals specified by the manufacturer or system integrator and this period must not exceed 10 years. Periodic test reports and a log of inspections must be maintained by the Interconnection Customer and made available to the Area EPS Operator upon request. The Area EPS Operator must be notified prior to the testing of the protective and control systems to witness the testing if so desired. The testing procedure for re-test should be a functional test of the protection and control systems.

Any system that depends upon a battery for trip/protection power must be monitored and inspected at least once per month for proper voltage. Logging of this periodic inspection is recommended. For systems with a nameplate rating of 250kW or more, 24/7 monitoring of the DC battery voltage is required.

7.2 O&M Agreements

The operational and maintenance requirements are documented in Attachments 5 and 6 of the Interconnection Agreement. Attachment 5, the Operating Agreement, covers items that are necessary for the reliable operation of the Local and Area EPS and may be unique to each DER installation. The following are some of the possible items which may be included as operating requirements: (TIIR Section 15)

- i. Operational requirements, settings, and limits for DER when the Area EPS is in a normal condition*
- ii. Operational requirements, settings, and limits when the Area EPS is in an abnormal condition due to maintenance, contingencies, or other system issues*
- iii. Permitted and disallowed ESS Control Modes*
- iv. BPS or TPS limitations and arrangements that could impact DER operation*
- v. DER restoration of output or return to service settings and limitations*
- vi. Response to control or communication failures*
- vii. Performance category assignments (normal and abnormal)*
- viii. Dispatch characteristics of DER*
- ix. Notification process between Interconnection Customer and Area EPS Operator*
- x. Right of Access*

The following is a list of typical items that may be included as Maintenance Requirements. The items included as Maintenance Requirements are not limited to the items included in this list:

- i. Routine maintenance requirements and definition of responsibilities*
- ii. Material modification of the DER that may impact the Area EPS*

7.3 System Voltage

Operation of the DER must not cause the voltage at the PCC to go outside of ANSI Range A under normal conditions. The operation of the DER system must also not adversely affect the Area EPS distribution system voltage balance among the phases and must be able to operate under the existing feeder voltage unbalance conditions. Operation of the DER that causes voltage issues may be cause for disconnection until the reason can be identified and corrected.

Any sudden voltage changes caused by the DER which adversely affect other customers will not be allowed. It is the Interconnection Customer's responsibility to resolve adverse voltage changes caused by the operation of the DER.

7.4 Power Ramp Rates

7.4.1 Overview

The ability for the Area EPS to respond to large changes in increasing or decreasing demand for energy depends upon the location of where the DER is interconnected with the Area EPS. Step changes in load or energy production affect the voltage levels due to the rapid change. Also, if the step increase in current is large enough, it could be mistaken for a fault by protective devices and result in an outage. The larger the step change in load or generation the greater chance of creating operational problems for other customers on the municipal electric system.

As part of the interconnection study, the Area EPS Operator will review the potential for step changes in load or energy production to create operational problems on the Area EPS. The Area EPS review does not look at potential Local EPS issues which may result from block changes in load or generation from the DER, this is the responsibility of the Interconnection Customer.

7.4.2 Requirements

The Area EPS Operator will review the proposed DER to see if any power quality issues would be expected from the interconnection and operation of the proposed DER. The Area EPS uses a maximum of a 3% voltage step change for a step change in DER output.

DER systems must not cause the Area EPS voltage to go outside of the ANSI range A voltage levels. This is during normal operation and during times when the DER generation is entering or leaving service. Block loading or off-loading of the DER generation that cause voltage step changes of 3% or more on the Area EPS are not allowed. The Operation section of the Interconnection Agreement may document unique operational requirements for the DER.

7.5 Enter Service

Each time a DER is starting operation is referred to as Enter Service. The method a DER uses to Enter Service is important for the reliability and performance of the Local EPS and the Area EPS. Enter Service could be after a power outage or as part of the daily normal operation of the DER.

Upon restoration of the Area EPS, after a prolonged outage, many appliances will automatically restart and place a heavy demand upon the Area EPS for energy.

Because of this, Energy Storage Systems are asked to delay their recharging of the ESS for a period of time to allow the increased demands from the other appliances to first be satisfied. All DER must delay reconnection to the Area EPS system for at least 5 minutes after normal voltage and frequency is restored, per IEEE 1547.

Any limitations on the way the DER system enters service will be documented in the operating section of the Interconnection Agreement.

7.5.1 Non-Energy Storage Systems

The following are some possible methods which may be required to be used.

- The delay time for restarting of the DER after an outage may be increased
- The DER must stagger the restarting of inverters under normal restarting and after an outage (maximum step amount of staggering required will be defined)
- Multiple transfer switches may be required for block loading DER to break up the blocks of load transferred to the DER

7.5.2 ESS (see also ESS Section 10)

ESS systems can affect the Area EPS through large step changes in recharging the ESS or through block load transfers from/to the Area EPS and the ESS. See Section 10 for the Enter Service requirements. The Operating Agreement (Attachment 5 of the Interconnection Agreement) will document the operational requirements for the DER. The following are some possible methods which may be required to be used:

- The delay time for restarting of the DER after an outage may be increased
- The charging of the ESS may require a predefined ramp rate
- The discharging of the ESS may require a predefined ramp rate

8 Power Control Systems

8.1 General

Power Control systems are used to control the output from a DER system due to an external condition. For example, the output from a DER unit may be limited so that it does not export energy back into the Area EPS system at the PCC.

8.1.1 DER Limiting Power Control System Requirements

The Power Control system must be NRTL certified and meet the following requirements.

- (1) For Power Control systems which are installed to control export to the Area EPS, it must be able to halt or reduce energy production within two seconds after either the period of continuous export to the Area EPS exceeds 30 seconds or the level of export exceeds the lesser of 100kW or 10% of the DER Nameplate Rating. Or, if the Power Control system is being used to limit the DER capacity, the Power Control system must be able to halt or reduce energy production within two seconds after either the period of DER output across the PoC exceeds defined DER capacity level for 30 seconds or the level of inadvertent DER energy output is 100kW or 10% over the defined DER capacity level.
- (2) Able to monitor the total energy flow across the PCC or PoC, as applicable.
- (3) Able to self-monitor the operational status of the Power Control system, such that failure of the ability to monitor the energy flow or failure of the ability to control the output of the DER, results in halting the production of energy by the DER or the separation of the DER system from parallel operation with the Area EPS.
- (4) The configuration and settings governing the power control limiting functions must be password protected, accessible only by qualified personnel.
- (5) If the power to the Power Control system is not available, the DER system must be blocked from operating in parallel with the Area EPS.

8.1.2 Documentation

The following is a list of information which is to be provided to the Area EPS Operator as part of the application filing, if the DER system relies on the Power Control system to regulate the output of the DER and/or limits the charging of the DER ESS. Generally, the Area EPS

Operator will need enough information to understand how the Power Control system will operate; how it will be installed; what the intended function(s) of the Power Control system is; and how the monitoring will be accomplished.

- (1) Manufacturer and model of the Power Control system
- (2) NRTL certifications of the Power Control system
- (3) Electrical schematic of the Power Control system monitoring and control
- (4) User manual for the Power Control system
- (5) Maximum response time for the Power Control system to modify the output of the DER, in response to a large step change in the local electrical loads.
- (6) Description of the reason for the Power Control system and active modes (from the user manual) which will be utilized. For example, “the power control system is designed to only allow importing of energy and will modify the DER operation to eliminate exporting across the PCC”
- (7) Description of how other possible operating modes (shown in the user manual) are being restricted so they are not able to be enabled
- (8) Other information which is useful to help the Area EPS Operator to understand the Power Control system installation and operation

8.1.3 Inadvertent Export

Inadvertent export is the flow of energy, in excess of a defined amount, through the PCC and back into the Area EPS system. Inadvertent export may occur during sudden changes in electrical demand on the Local EPS and must be quickly resolved through the automatic adjustment of the DER output through the direction of the DER’s Power Control system.

Inadvertent export, if it is large enough, could damage Area EPS equipment or cause tripping of protective devices and a resulting power outage. For DER systems which are designed as non-exporting, the Area EPS has not been constructed to support the reverse flow of energy and may not be able to support it.

Inadvertent export must be limited to 10% of the DER nameplate rating or 100kW, whichever is less, for a maximum of 30 seconds. The cumulative amount of inadvertent exported energy from the Local EPS to the Area EPS, across the PCC, in any billing month must be less than the on-site

aggregated DER Nameplate Rating(s) multiplied by one hour. The Power Control system must be designed to limit inadvertent export to these levels, unless otherwise mutually agreed to between the Area EPS Operator and the Interconnection Customer and documented in the operating section of the Interconnection Agreement (or Operating Agreement).

Any amount of inadvertent export of real power across the PCC lasting longer than 30 seconds for any single event must result in the disconnection of the DER system from the Area EPS within 2 seconds of exceeding the 30-second duration limit.

9 Interoperability

There are different interoperability requirements depending upon the method of interconnection and the size of the DER system. Larger systems often can have a much more significant impact on the electric distribution system, and therefore need more advanced monitoring.

9.1 Monitoring

Remote monitoring of the DER system by the Local Utility is required once the DER is greater than 250kW in size. The specific communication method will depend on the location of the DER installation and the requirements of the Local Utility.

The final points list of the status, control and analog points required to be monitored and possibly controlled by the Local Utility system will be defined within the operational section of the Interconnection Agreement. Below are typical points which would be required, which may vary depending on the size and design of the DER installation.

- Status Points
 - Status of any lockout relay
 - Status (open/close) of the interconnection breaker(s) or if a transfer switch is used, status of each transfer switch. Hard wired from monitoring RTU directly to the breaker, not supervised by the breaker relay.
 - High voltage alarm (settings defined by Local Utility)
 - Low voltage alarm (setting defined by Local Utility)
 - DC supply / charger trouble alarm
 - Trouble alarm (relay failure alarm) from each protective relay providing the utility required protection elements.
 - General Trouble Alarm, can be a common alarm or individual alarms, need to include generation control trouble, issues with DC voltage.
- Control Points
 - Remote control of interconnection breaker (open / close) hard wired from Local Utility RTU directly to the breaker, not supervised by the breaker's relay. The reclose must be supervised by the lockout relay.
 - Ability to start and stop DER and transfer load off the system. (if required)
 - Ability to remotely turn on/off modes of operation, and/or monitor which modes of operation are active. (if applicable)

- Analog Values (Values updated at least every 10 seconds)
 - Individual phase voltage values representative of the Area EPS's service to the facility.
 - Individual Phase amps (DER output)
 - DC voltage from protective DC battery
 - 3 Phase Real (kW) and reactive (kVAR) power flow for each DER unit.
 - Power quality values such as Total current harmonic distortion (Current THD), Total current demand distortion (TDD), and Total voltage harmonic distortion (Voltage THD)

9.2 Direct Transfer Trip

In special circumstances, the Local Utility may require direct transfer trip (DTT) of DER. This involves the utility sending a signal to a customer-owned recloser or breaker to disconnect from the Local EPS. DTT may need to be used based on the size of the DER and relative system loading or other unique system conditions that are identified during the study process.

9.3 Security

9.3.1 Physical and Front Panel

It is the responsibility of the Interconnection Customer to maintain physical security for equipment and all communication interfaces at the DER site. The configuration settings for all DER equipment that provide protection or control must be password protected to allow access only to qualified personnel.

9.3.2 Network Security

It is the Interconnection Customer's responsibility to ensure cyber security of the DER system. The Interconnection Customer is responsible for ensuring that there are no possible cyber connections with the internet through Interconnection Customer communication systems which are also connected to the Local Utility communication systems. Any communication link between on-site pieces of DER equipment and Local Utility equipment must be a direct link and not use a shared communication channel with any other communication.

10 Energy Storage Systems (ESS)

10.1 General

Energy Storage Systems (ESS) are subject to witness testing in the same manner as other DER systems. The Area EPS Operator will require the testing of the interconnected ESS along with any other DER installed at the location. The addition of an ESS to an existing DER installation may necessitate the re-testing of the aggregate DER system.

10.2 Defining Common Modes of Operations

This section defines a set of common operational modes for ESS. One or more of these operating modes can be selected in the DER interconnection application. The process used to review the ESS interconnection application will depend upon which of the modes have been selected. If the ESS will have the capability of operating in more than one operating mode, then all the operating modes must be listed on the interconnection application.

It is important that the interconnection application and the supporting information attached address the following questions about the ESS operational characteristics:

- Is the ESS designed to export power back into the Area EPS?
- If the ESS is not designed to export power back into the Area EPS, how is the physical configuration and/or control system designed to ensure that power is not exported?
- For failure of the ESS control system or failure of an automatic isolation switch, what will stop the ESS from exporting to the Area EPS?
- How can operational control modes be changed?
- Are all operational modes available to be changed / used by the end user?
- If some operational modes are not available to the end user, how are they locked out?

The use of ESS is rapidly evolving so this section has been written to provide the information for the expected ESS use cases. The following operating modes are the expected standard modes, but DER/ESS systems may be designed for different operating modes than are listed here. Please contact the Area EPS Operator's DER Interconnection Coordinator to discuss any unique operating modes.

10.2.1 Emergency Power

The Emergency Power operating mode is designed so the ESS is only providing energy to the Local EPS during a power outage or during storms and other periods requiring high reliability and will not be providing energy to the Local EPS at other times. Selecting this mode requires the interconnection with the Area EPS to be disconnected when supplying energy to the Local EPS. The ESS is normally sitting fully charged, waiting

for an event such as a power outage.

After the power outage, the ESS needs to be recharged. Immediately recharging the ESS after a power outage will create a greater demand upon the Area EPS than is typical, and may result in placing an increased demand on the Area EPS and the local service. This could create higher demand charges and could overload the Area EPS. To help eliminate this risk, the ESS is requested to delay the recharging of the ESS for 30 minutes after restoration of the power outage. The ESS is required to keep supplying the local load connected to the ESS for at least 5 minutes after restoration of power on the ESS.

10.2.2 Demand Reduction Management

In Demand Reduction Management mode the ESS is used to reduce the peak demand of the Local EPS. This can be referred to as demand management, peak shaving or peak load reduction. The ESS is operating to reduce the peak demand of the Local EPS and is often controlled by a Power Control system that is monitoring the total load of the Local EPS. The ESS outputs energy into the Local EPS during peak load periods to offset the purchase of energy from the Area EPS. With this operating mode, the ESS has the potential to back feed the Area EPS during events, such as faults on the Area EPS or for step load changes in the Local EPS.

The charging of the ESS is typically limited to periods when the Local EPS loads are minimal, so as not to cause a higher demand.

10.2.3 Non-Exporting/Self-Consumption

In Non-Exporting/Self-Consumption mode the ESS is used to store energy during periods of excess or low-cost energy for use during other times. This could be used to charge during the evening for use during the day with a time-of-use rate, or used as a form of net metering for systems which are larger than 40kW to not export excess renewable energy to the utility during high solar output periods, so the energy can be used by the Local EPS at other times.

10.2.4 PEV

In PEV mode the ESS is used to dampen voltage swings due to Solar / wind variable output, and/or utilize the ESS to reduce utility demand charges by filling in dips in variable renewable energy production.

10.2.5 Grid Services

The requirements and distribution energy tariffs for distribution connected Energy Storage Systems to provide grid support functions have not yet

been developed. At this time, use of ESS interconnected with the Area EPS distribution system to provide grid services is not permitted.

10.3 Control System Requirements

10.3.1 Enter Service

After any sustained electrical outage, the energy storage system must be configured to not immediately initiate recharging of the ESS. Per the IEEE 1547 standards, the ESS must wait a minimum of 5 minutes after the Area EPS is reenergized and provides a stable voltage and frequency, before initiating recharging of the ESS.

It is preferable to delay any recharging of the ESS for a minimum of 30 minutes after re-energization of the Area EPS, to allow the distribution system to fully stabilize and reduce the possibility of additional electrical demand caused by the recharging of the ESS to overload the distribution system.

To help reduce the possibility of step voltage issues and other distribution system issues, it is also preferable to have the ESS control system ramp up the recharging level from 0-100% over a 5-minute time period upon entering service.

10.3.2 Modification of Operating Modes

The ESS control system must be secured and password protected to ensure operating modes that have not been studied and approved by the Area EPS Operator cannot be utilized. The ability for the homeowner, business owner or employee of the business to turn on additional modes that have not been reviewed and approved must be strictly controlled. Only qualified service personnel may have access to turn on additional modes of operation after review and approval by the Area EPS Operator.

11 Metering Requirements

Metering requirements depend upon the type of DER, the applicable tariffs, the method of interconnection and the size of the DER. In general, the Interconnection Customer is responsible for providing and installing the meter socket and the Local Utility will provide and install the meter. The Interconnection Customer must allow the Local Utility access to the DER system to inspect and ensure revenue metering and monitoring is accurate.

11.1 Factors Affecting Metering Requirements

The following is an educational discussion on the different factors which affect the type of metering required for the interconnection of a DER system. Section 8 of the TIIR provides a general scope of the reasons for the development of metering requirements.

- *Operational – near-real-time information on the DER operating characteristics can be needed in order to perform certain actions such as reconfiguring a feeder or restoring a feeder after an outage.*
- *Planning – an archive of time-series information over multiple years of DER operation is required for Area EPS, BPS and TPS planning.*
- *Regulatory – The Area EPS Operator may have obligations to track and report on the amount of energy produced from renewable energy DER¹. Specific incentive programs or tariffs can create additional metering needs.*
- *Billing – the Area EPS Operator is responsible for accounting for energy transactions with the Interconnection Customer and shall have access to revenue-grade metering information.*

11.1.1 Net Metered Interconnection

The Local Utility is required to net meter qualified DER that has an aggregate Nameplate Rating of less than 40kW and interconnected with the distribution system. Net metering allows the customer's DER to generate excess energy, greater than the local load requirements and push that energy back into the Area EPS and then later allows the customer to use energy equal to the excess energy amounts without charge. Over the course of a billing month the excess energy generated by the DER is used to offset some or all the energy used by the customer.

Net metering requires the separate measurement of energy flow, both into and out of the electrical service for the home or business. To support this type of interconnection, the main service meter will be replaced or reprogrammed to measure and record energy flow in both directions.

¹ Renewable energy credits for certain Area EPS Operator tariffs is an example of reasons to track energy production.

11.1.2 Third Party Power Purchases

A third party may be purchasing the output of the generation, as permitted by the Public Utility Regulatory Policies Act of 1978. The metering requirements will be dependent upon many factors, including the requirements of the power purchase agreement. The TSM does not directly address the requirements for all types of installations. Contact the Area EPS DER Interconnection Coordinator to discuss any DER that is considering third-party purchase of the energy from the DER.

Depending upon the power purchase agreements or applicable tariffs, real-time communication with the meters may be required. If communication is required, the Interconnection Customer is responsible for all costs to implement and maintain the required communication. See the Interoperability section of the TSM for more information about communication requirements.

11.1.3 Standby Service

The Local Utility will provide standby service to DER systems as set forth in the Local Utility's standby tariffs and in accordance with all applicable laws and regulations.

11.1.4 Metering when Installing Multiple Types of DER

How the DER is connected and operated may affect the method of metering for specific tariffs. Also, when multiple types of DER are installed on the same electrical service, interaction between different tariff requirements may affect the metering requirements. Another factor which may affect the installation is the operating mode(s) of the DER. This is especially true for Energy Storage Systems (ESS). The operating mode(s) of the ESS will affect the placement and type of metering and possibly could affect which tariffs are applicable. See Energy Storage Section of the TSM for information about metering requirements for DER systems which include Energy Storage.

11.2 General Requirements

The metering requirements may vary depending on the specific service, type of interconnection and type and size of DER system. The installation of the meter must follow the Local Utility metering installation requirements. Some of the basic requirements include:

- All meter sockets must be bypass-type sockets, with a manually operated lever bypass
- All metering for a single service must be grouped within a 10 feet area
- The center of the meter socket must normally be mounted at a height between 4 to 6 feet above the ground, to allow safe reading of the meter

- Meters must be protected from damage

11.3 Location and access of metering

All metering must be accessible by utility crews 24/7/365 with an open walkway to the meters that is clear of shrubs, bushes, etc. The meter must not be behind a locked fence or door, unless there is written agreement between the Interconnection Customer and the Local Utility.

11.4 Main Meter (PCC)

The Area EPS's Point of Common Coupling (PCC) meter is owned and maintained by the Area EPS Operator. For an existing building, this is the existing main service meter, which may need to be replaced if it is not presently bi-directional. The Local Utility supplies the main bi-directional meter and for larger commercial services any necessary voltage transformers (VT) and current transformers (CT). The Interconnection Customer is required to provide and install the meter socket that meets the Local Utility metering requirements, with a bypass lever.

11.5 Production Meter (PoC)

The production meter allows for the historical recording of the DER output. This data can be made available to the customer upon request to identify operational issues with the DER output levels. The data will also be used by the Area EPS Operator to properly maintain a safe and reliable grid.

11.5.1 Production Meter Required for Extended Parallel

Unless exempted in Section 11.5.2, a production meter is required to be installed to measure the output of the DER that operates in extended parallel with the Area EPS Operator's distribution system. The Interconnection Customer is responsible for the installation and cost of a meter socket with a bypass lever. The Local Utility will provide, install and operate the production meter at no additional cost to the Interconnection Customer.

11.5.2 Production Meter Not Required

A production meter is not required if the DER is designed to operate and carry the customer's load disconnected from the Area EPS. An example of this is with a DER that is connected to the load using a physical transfer switch which moves the load from the Area EPS to the DER generation. A production meter is not required even if the transfer switch momentarily parallels the DER with the Area EPS, but the DER normally supplies the load isolated from the Area EPS.

A production meter is also not required for Energy Storage Systems (ESS), if

the ESS is smaller than 250kW and designed to not export to the Area EPS. A production meter is required if other DER systems, such as a solar generator, is installed along with the ESS. In this case, the production meter must be installed to measure only the solar system energy output.

11.6 Metering Configurations for Example Residential Use Cases

11.6.1 Single Residential DER system

The following is a one-line diagram showing a typical wiring for a solar system and the production meter.

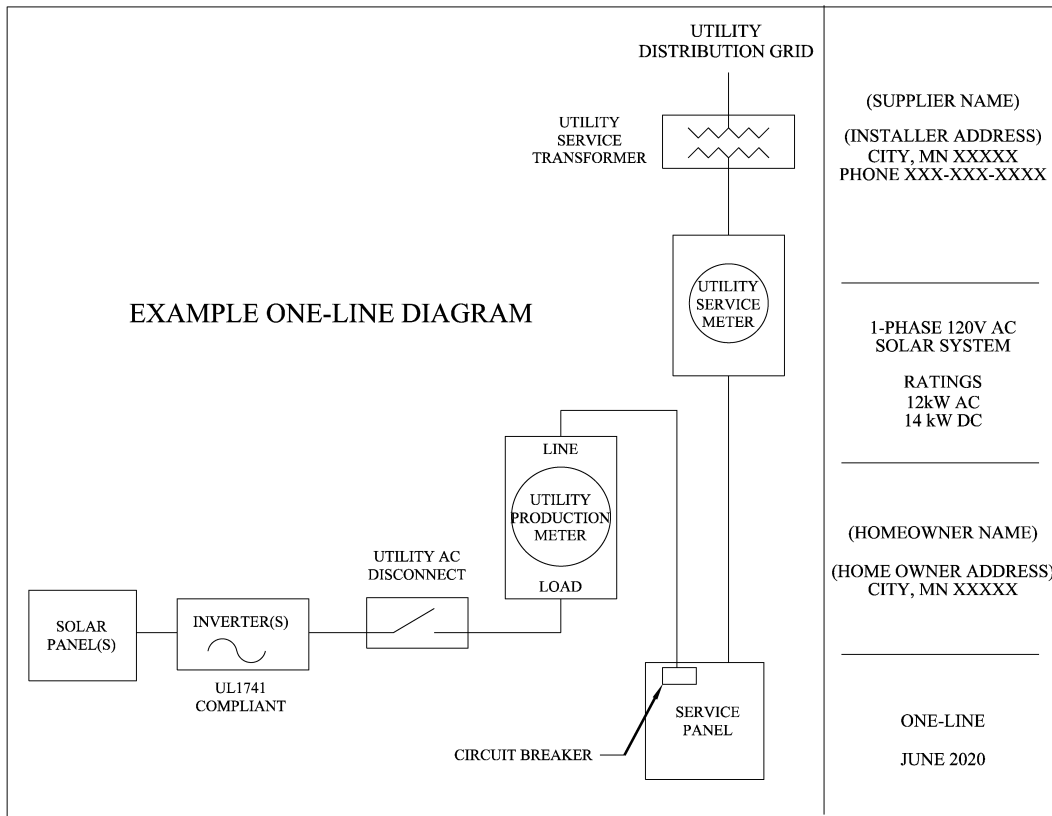

12 Signage and Labeling

12.1 General

All signage and labeling must meet the applicable NEC requirements. In order to provide a safe operating environment for Local Utility personnel, additional labeling and signage requirements must be met.

12.2 Utility AC Disconnect

The Utility AC Disconnect must be labeled as “DER Utility AC DISCONNECT”.

If a single Utility AC Disconnect cannot be used to disconnect all DERs, all Utility AC Disconnects should include numerical identification such as “DER Utility AC DISCONNECT 1 of 2” or similar. The number of disconnects required to be operated to completely isolate the DER(s) from the utility should be clear.

12.3 Main Meter

A sign at the main service entrance meter must indicate that the location contains DER(s). Each type of DER present must be listed (i.e. PV, Wind, ESS, Gas Generator). The sign must provide clear direction to the distance and location of all Utility AC Disconnects. The preferred sign must be a site map of the area with an X for the main service entrance meter location and an O for the Utility AC Disconnect location. A map must include outline of all structures in the area and compass arrow for orientation.

12.4 Production Meter

The production meter must be labeled as “Production Meter”. In cases where multiple production meters exist on the load side of the main meter, each production meter must be labeled as such to identify which DER unit is being metered.

TABLE 12-1				
Metering, Monitoring, and Control Requirements				
Generation System Capacity at PCC	Metering at PCC	Metering at PoC	Generation Remote Monitoring	Generation Remote Control
< 40 kW Inverter Connected System	Area EPS Bi-Directional Metering	Customer to install meter socket (w/bypass) for future metering requirements	--	---
40 – 250 kW with limited parallel	Area EPS Bi-Directional Metering	Customer to install meter socket (w/bypass) for future metering requirements	None Required	None Required
40 – 250 kW with extended parallel	Area EPS Bi-Directional Metering	Customer to install meter socket (w/bypass) for future metering requirements	Interconnection Customer supplied direct dial phone line. Area EPS to supply its own monitoring equipment	None Required
250 – 1000 kW with limited parallel	Area EPS Bi-Directional Metering	Customer to install meter socket (w/bypass) for future metering requirements	Interconnection Customer supplied direct dial phone line and monitoring points available.	None Required
250 – 1000 kW With extended parallel operation	Recording metering on the Generation System and a separate recording meter on the load		Required Area EPS (potential transmission provider) remote monitoring system.	None Required
>1000 kW With limited parallel Operation	Area EPS Bi-Directional Metering	Customer to install meter socket (w/bypass) for future metering requirements	Required Area EPS remote (potential transmission provider) monitoring system.	None required
>1000 kW With extended parallel operation	Recording metering on the Generation System and a separate recording meter on the load.		Required Area EPS remote (potential transmission provider) monitoring system.	Direct Control via SCADA by Area EPS of interface breaker

13 Test and Verification Requirements

13.1 Procedure

13.1.1 Procedure for DER systems Larger than 40 kW or not with Inverter

For DER systems which are larger than 40kW or not utilizing a certified inverter, the Interconnection Customer must provide a testing procedure to the Area EPS Operator prior to the scheduled inspection and testing of the DER system. The criteria to be included in the testing procedures is listed in Section 13.2 and Section 13.3. The Interconnection Customer should also review Sections 13.4 through 13.6 for potential requirements and consult with the Area EPS Operator's DER Interconnection Coordinator.

13.1.2 Procedure (and Testing) for DER systems which are 40 kW or Smaller and Using Inverter

For DER systems which are 40kW or smaller and utilizing a certified inverter for interconnection, the simplified process testing procedure outlined in the TIIR will be followed. The general process that the Area EPS Operator will use for the final test and inspection for simplified systems is outlined in the TIIR and is as follows:

- *Verify installation matches design evaluation*
 - *Verify inverter model matches application*
 - *Verify certified inverter*
 - *Verify correct labeling / signage*
 - *Verify installation matches application one-line diagram (i.e. connections, location of protection, disconnect switch, metering, etc.)*
 - *Verify electrical inspection sticker*
 - *Verification of operational and protection settings*
- *Field Testing*
 - *On-off test*
 - *Open phase testing (if applicable for multi-phase DER systems)*

SEE CHAPTER 14 FOR SAMPLE DOCUMENTATION

13.2 Pre-Interconnection Commissioning Testing: >40 kW Interconnection

The following inspections and testing are required to be completed by the Interconnection Customer prior to the Area EPS Operator representative arriving onsite for interconnection testing.

13.2.1 Grounding

Grounding must be verified to ensure compliance with the TIIR, TSM, NESC and the NEC requirements.

13.2.2 CTs & PTs

If applicable, Current Transformers (CTs) and Voltage Transformers (VTs) used for monitoring and protection must be tested to ensure correct polarity, ratio and wiring. CTs must be visually inspected to ensure that all grounding and shorting connections have been removed where required.

13.2.3 Breakers

If applicable, verify that the breaker or switch cannot be operated with interlocks in place or the breaker or switch cannot be automatically operated when in manual mode.

13.2.4 Relays

If applicable, all protective relays must be calibrated and functionally tested to ensure the correct operations of the protective elements. Prior to this point in the process, the Local Utility should have received relay settings for all utility required protective relaying and have completed the utility coordination review and approval.

Protective relaying must be functionally tested to ensure the correct operation of the complete system. Functional testing requires that the complete system is operated by the injection of current and/or voltage to trigger the respective relay elements and proving that the relay elements trip the required breaker, lockout relay and/or provide the correct signal to the next control element. Trip circuits must be proven through the entire scheme. Lockout relays must be tested to prove that when tripped the ability to reclose the associated breaker or switch is blocked.

13.2.5 Remote Control

If applicable, all required remote control functions and remote monitoring points must be verified operational. In some cases, it may not be possible to verify all the analog values prior to energization. Where appropriate, those points may be verified during the energization process.

13.2.6 Phase Tests

For multi-phase DER systems, phase tests must be completed to ensure proper phase rotation of the generation and wiring. UL 1741 certified inverters that do not intentionally island are not required to perform this test.

13.2.7 Synchronizing Tests

The synchronizing tests must be done across an open switch or racked out breaker. The switch or breaker must be in a position that it is incapable of closing between the DER and the Area EPS system for this test. This test must demonstrate that at the moment of the paralleling-device closure, the frequency, voltage and phase angle are within the required ranges, stated in IEEE 1547. This test must also demonstrate that if any of the parameters are outside of the ranges stated, the paralleling-device will not close. For inverter-based interconnected systems, this test may not be required unless the inverter creates fundamental voltages before the paralleling-device is closed.

13.2.8 Final System Sign-off

To ensure the safety of the public, all DER systems that do not utilize a certified inverter for interconnection must be certified as ready to operate by a professional Electrical Engineer, registered in the State of Minnesota, prior to the DER system being considered ready for onsite testing, unless otherwise agreed to by the Area EPS Operator.

13.3 Final Interconnection Commissioning Testing: >40 kW Interconnection or not with Inverter

The following tests will proceed once the DER system has completed pre-interconnection commissioning testing and the results have been reviewed and approved by the Area EPS Operator. For simplified certified inverter based DER systems, the Area EPS Operator will have a set of standard interconnection tests that will be required. On larger and more complex DER systems, the Interconnection Customer and the Area EPS Operator will coordinate with the development of the required testing procedure. All final interconnection commissioning tests must be based on written test procedures agreed to between the Area EPS Operator and the Interconnection Customer. The location and method of measurement must be listed for each step. The Interconnection Customer must provide qualified personnel and supply proper equipment to adequately record the results of these tests.

13.3.1 Verification

The Interconnection Customer must work with the Area EPS Operator representative to:

- Verify 24/7 unescorted access is available to Local Utility personnel
- Verify that the equipment listed on the application and the nameplates of the equipment used are the same
- Verify the installation matches the one-line diagram provided by the Interconnection Customer

- Verify that all required labeling meets TSM Section 12 requirements
- Spot check the settings of the protective relays, inverters and control systems, to verify that they match the information provided by the Interconnection Customer
- Complete final testing of any remote control and/or remote monitoring which could not be performed prior to this final testing.

13.3.2 Anti-islanding

For systems which operate in parallel with the Area EPS longer than 100 ms, the following testing will be required to test the anti-islanding functions of the DER:

- The DER system must be started and connected in parallel with the Area EPS source. It is recommended that this test be completed when the DER is able to produce at least 15% of the rated output for this test.
- Current, voltage, power factor, and direction of power flow must be verified.
- The Area EPS source must then be removed by opening a switch, breaker, etc.
 - For multi-phase systems, this test will include separate tests with an opening of all phases and opening of each individual phase, one at a time.
- The DER generation must either separate from the Area EPS together with the local load or stop generating within 2 seconds. Any voltages present on the DER side of the test point must be verified as less than 110% of nominal voltage.
- The device that was opened to remove the Area EPS source must be closed and the DER generation must not parallel with the Area EPS for at least 5 minutes, or per a mutually agreed upon enter service time.
- If the Interconnection Agreement specifies enter service requirements, then these will be verified at this point in the process as part of the restarting of the DER.

13.3.3 62PL Relay

For transfer switches which require a 62PL relay to limit the amount of time the DER is operating in parallel with the Area EPS, it is important that the following is confirmed before final testing of the installation is started:

- The 62PL relay must be a completely separate relay and not part of the DER control PLC or the transfer switch PLC.
- The 62PL actuation must be wired in series with the closed position of both transfer switches (Utility and Generator), so that when both switches are closed the 62PL timer is started.
- The 62PL relay must be wired to isolate the DER from the Area EPS by

tripping a breaker. (DER generator breaker preferred). Tripping of a transfer switch solenoid does not meet the requirement, as the solenoid actuator may be what has failed.

13.3.4 Control Modes

For DER systems which utilize inverter settings, a PLC, or other type of Power Control system to limit the output of the DER to a control level, the testing of the overall Power Control system must be performed as part of the final interconnection commissioning test. The testing procedure must be developed to confirm the ability of the Power Control system to limit unintended DER output levels, including the ability to quickly resolve inadvertent exporting.

13.3.5 Confirm phasing

For multi-phase DER systems, the phasing between the DER and the Area EPS must be confirmed before the DER is interconnected with the Area EPS. The Local Utility requires it be present to witness the testing being performed. Confirmation of the correct phase connections and phase rotation must be by testing the phase voltages across an open point between the DER generation and the Area EPS.

13.3.6 SCADA and Communications

For DER systems which require SCADA or other communication with the Area EPS system, if not completed before the final on-site testing, each of the SCADA points must be tested to confirm correct data and intended operation. It is most efficient to have any communication and SCADA points tested before the final testing.

13.3.7 Enter Service

Testing of the ability of the DER to meet any Enter Service requirements must be part of the final testing process.

13.4 Documentation

The Interconnection Customer must provide a written test report to the Area EPS Operator within 10 days of the testing and verification of the DER. The documentation must include the following, as applicable:

13.4.1 Grounding

Documentation required:

- Grounding equipment nameplate drawing.
- Ground referencing calculations.
- Drawing of ground referencing equipment protection schemes.

- Written verification that grounding equipment meets NEC and NESC.

13.4.2 Potential and Current Transformers

Documentation required:

- Written verification that the correct PTs and CTs are installed.
- Written verification that the CTs shorts and ground have been removed, when applicable.
- Details on main site protection.

13.4.3 Breakers and Switches

Documentation required:

- Written verification that all breakers, switches and associated controls function properly.

13.4.4 Relays

Documentation required:

- Copy of as left protection settings (relay and/or inverter(s))
- Signed verification of relay calibration and testing.

13.4.5 Fault Current

Documentation required:

- If not already provided during the application or study process, fault current characterization information required in IEEE 1547, section 11.4 must be provided. This is required for synchronous and induction generation and electronically coupled DER with the aggregated rated capacity of 500 kVA or larger.

13.5 Failure Protocol

If the DER system fails testing and verification, the Interconnection Customer must correct outstanding issues and provide updated documentation to the Area EPS Operator on the changes made. The Interconnection Customer must schedule a testing and verification date with the Area EPS Operator. If necessary, a revised testing procedure should be provided to the Area EPS Operator.

13.6 Hardware or Software Changes

Whenever interconnection system hardware, software or firmware is changed there can be an effect on the equipment and functions listed below. Re-commissioning of equipment is required for all hardware changes impacting the interconnection listed as follows:

- Switchgear and conductors
- Protective relays
- RTUs and sensors

- Communication devices
- Inverters

A re-test is required of all potentially affected functions, including, but not limited to, the following:

- Over voltage and under voltage
- Over frequency and under frequency
- Fault Detection
- Inability to energize a de-energized line
- Time-delay restart after EPC Distribution System outage
- Reverse or minimum power function (if applicable)
- Synchronizing controls (if applicable)
- Anti-islanding functions (if applicable)

14 Sample Documents for Simplified Process

14.1 One-line diagram

The following is a sample one-line diagram for a basic DER interconnection. The more information provided on the one-line diagram the better the Local Utility is able to understand what is proposed to be installed. This improves the ability to review the installation. Please note that for DER installations which require a production meter, the DER is wired to the LOAD side of the production meter.

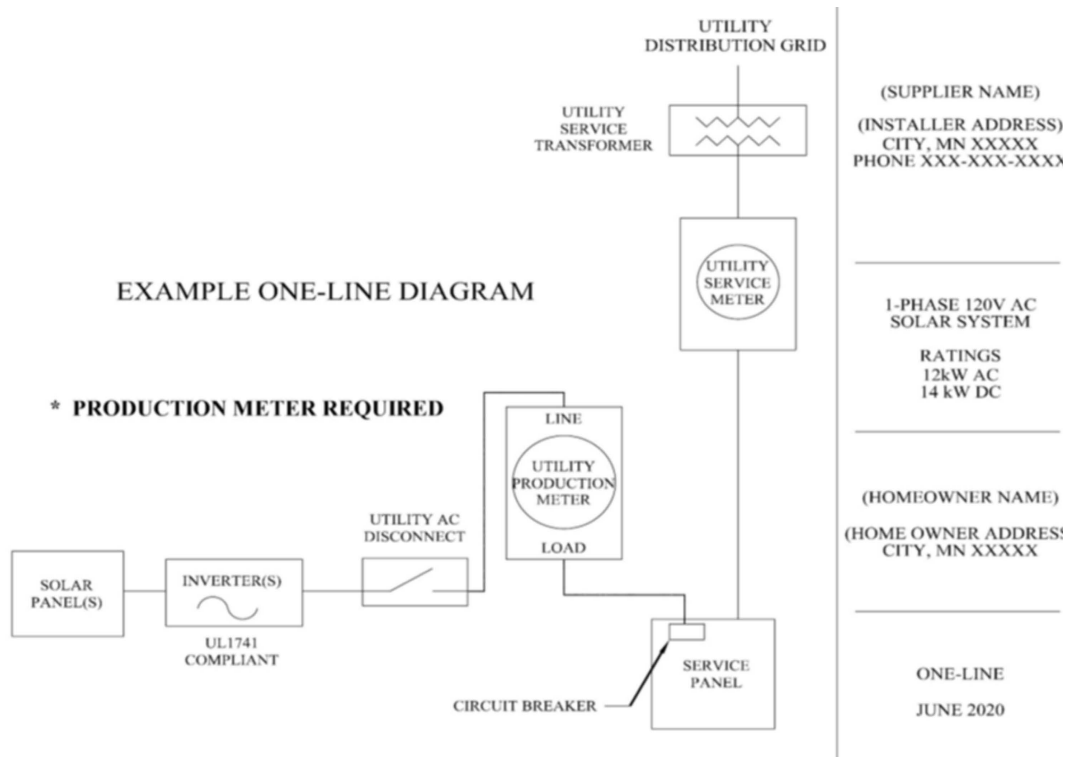

The information required on the one-line diagram includes:

- Name of the customer located at the electrical service where the DER is proposed to interconnect
- The connectivity of all equipment between the utility PCC and the proposed DER, including, switches, breakers, fuses, junction boxes, combiner boxes, protection devices, etc.
 - Utility AC Disconnect (visible gap)
 - Main Service meter and the production meter (if required)
- Aggregate nameplate rated AC kW capacity of each DER system
- AC voltage of the system
- Number of phase (Single or Three phase)

- Diagram any control system wiring or communication between the elements
- Indicate the Point of Common Coupling (PCC)
- Indicate the Point of Connection (PoC)
- For Energy Storage Systems (ESS), the mode(s) of operation being applied for must be clearly indicated on the one-line diagram
- For DER systems larger than 250kW, a signature from a professional electrical engineer, licensed in the State of Minnesota

Notes:

When multiple DER units are existing or proposed on a single service: if a single Utility AC Disconnect cannot be used to disconnect all DER, all Utility AC Disconnects should include numerical identification such as “Utility AC Disconnect 1 of 2” or similar.

14.2 Equipment Certification Information

The interconnection application requests information about certified equipment. The information provided is used by the Local Utility during the review process to ensure compliance with local and national requirements and for documentation of the equipment proposed to be installed. The information being requested includes the following equipment:

- Inverter make and model number
- Power Control system (attach description and cut sheet)
- Energy Storage System, make and model number
- Protective Relays, make and model number

14.3 Site diagram

The site diagram or location plan that identifies the location of the equipment noted on the one-line diagram must provide the following information. If required, multiple drawings may be provided to reduce overall clutter and improve the ability to read the information.

- Name of the Customer located at the electrical service where the DER is proposed to interconnect
- Address of the proposed DER installation
- Installer name and contact information
- The site diagram must show at least one street on the drawing, with the street named
- Compass direction (indicate North)
- Distances between the Main Meter and the Production Meter and Utility AC Disconnect
- Location of DER equipment
- AC kW Rating

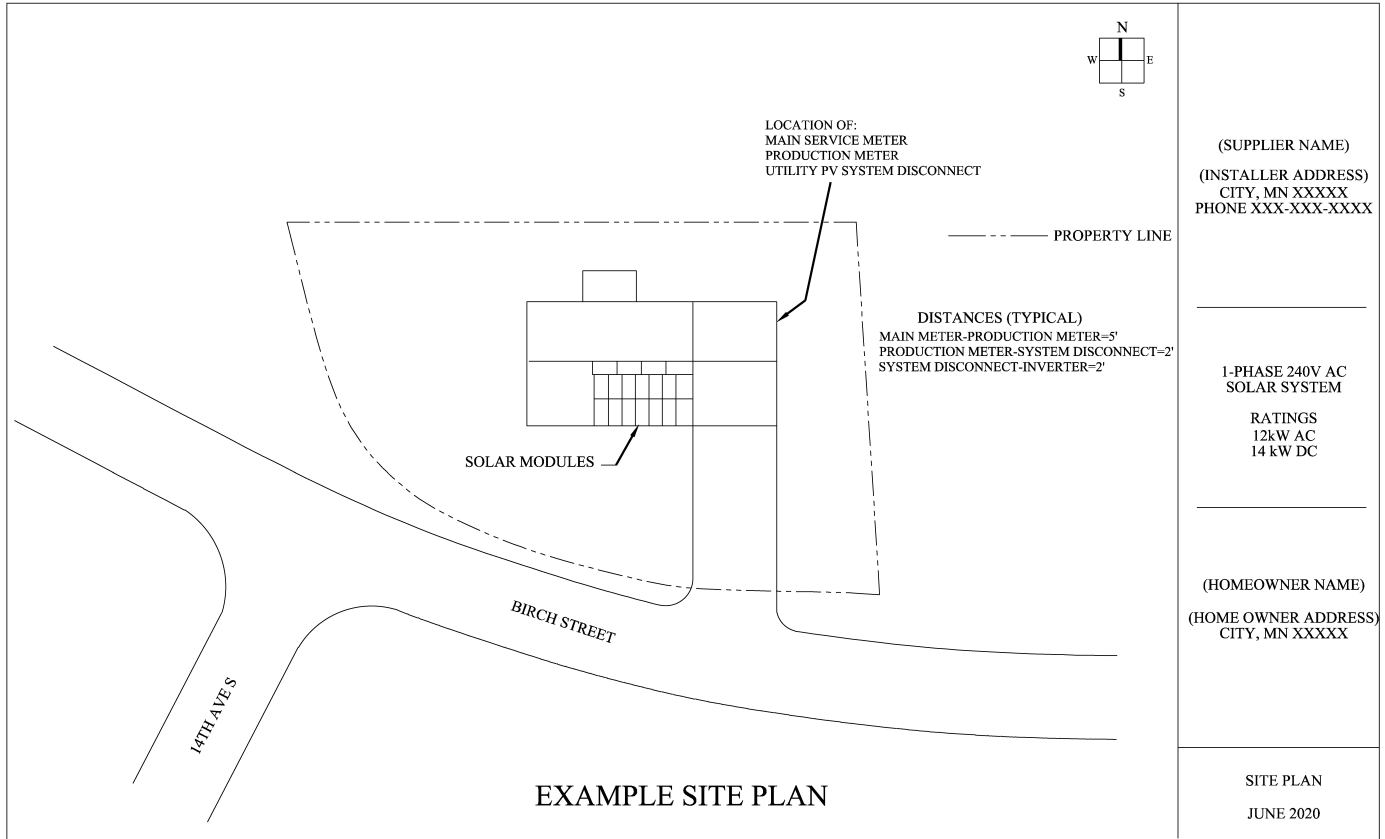

Appendix A – Protection and Connection One-line Drawings

How the DER is connected to and disconnected from the Local or Area EPS can vary. Solar and wind systems are normally interconnected using a UL 1741 certified grid intertie inverter. For other generation systems, a mechanical transfer system is typically utilized. Most transfer systems operate using one of the following methods of interconnection for transferring the load from the Area EPS to the DER system.

Note: If a transfer system is installed which has a user accessible selection of several transfer modes, the transfer mode that has the greatest protection requirements will establish the protection requirements for that transfer system.

A-1 Open Transition (Break-Before-Make) Transfer Switch

With this transfer switch, the load to be supplied from the DER is first disconnected from the Area EPS and then connected to the DER. This transfer can be relatively quick, but the load will experience a short outage with voltage and frequency excursions during transfer. Computer equipment and other sensitive equipment will shut down and reset, unless they are protected by a UPS. The transfer switch typically consists of a standard UL approved transfer switch with mechanical interlocks between the two source contactors that drop the Area EPS source before the DER generation is connected to supply the load.

To qualify as an Open Transition switch and be subject to the limited protective requirements, mechanical interlocks are required between the two source contacts. This is required to ensure that one of the contacts is always open and the DER generator is never operated in parallel with the Area EPS. If a mechanical interlock is not present, the protection requirements are as if the switch is a closed transition switch.

As a practical point of application, this type of transfer switch is typically used for loads less than 500kW. This is due to possible step voltage issues created on the Area EPS when the load is removed from or returned to the Area EPS source.

This is referred to as block load transfer. Depending up the Area EPS's stiffness, this level may be larger or smaller than the 500kW level. If the operation of the DER causes issues for other customers on the system, it is the Interconnection Customer's responsibility to cease operation and work with the Area EPS to resolve the issue. The Interconnection Customer is also responsible to pay for any required mitigation.

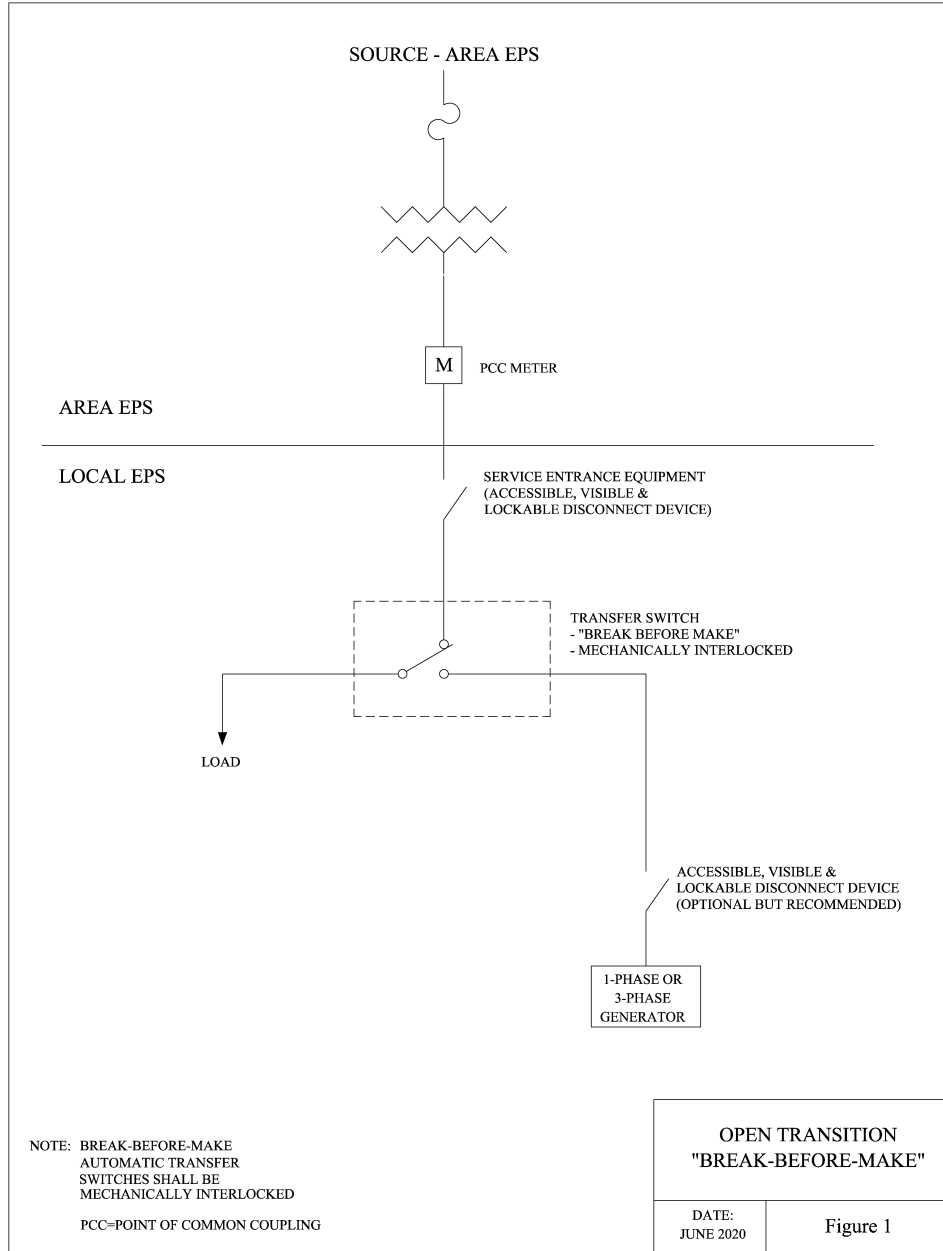

A-2 Closed Transition (Make-before-Break) Transfer Switch

With this transfer switch, the DER generation is synchronized with the Area EPS prior to the load transfer occurring. The transfer switch then parallels with the Area EPS for a short time (500 msec. or less) and then the DER generation with the load is disconnected from the Area EPS. This transfer is less disruptive than the Quick Open Transition, because it allows the DER generation a brief time to pick up the load before the support of the Area EPS is removed. With this type of transfer, the load is either being supplied by the Area EPS or the DER generation.

As a practical point of application, this type of transfer switch is typically used for loads less than 500kW. This is due to possible step voltage issues created on the Area EPS when the load is removed from or returned to the Area EPS source. Depending upon the Area EPS's stiffness, this level may be larger or smaller than the 500kW level.

The following figure provides a typical one-line diagram of this type of installation and shows the required protective elements. The closed transition switch must include a separate parallel time limit relay (62PL), which is via a completely separate relay from the generation control PLC and which disconnects the DER from the Area EPS for a failure of the transfer switch and/or the transfer switch controls.

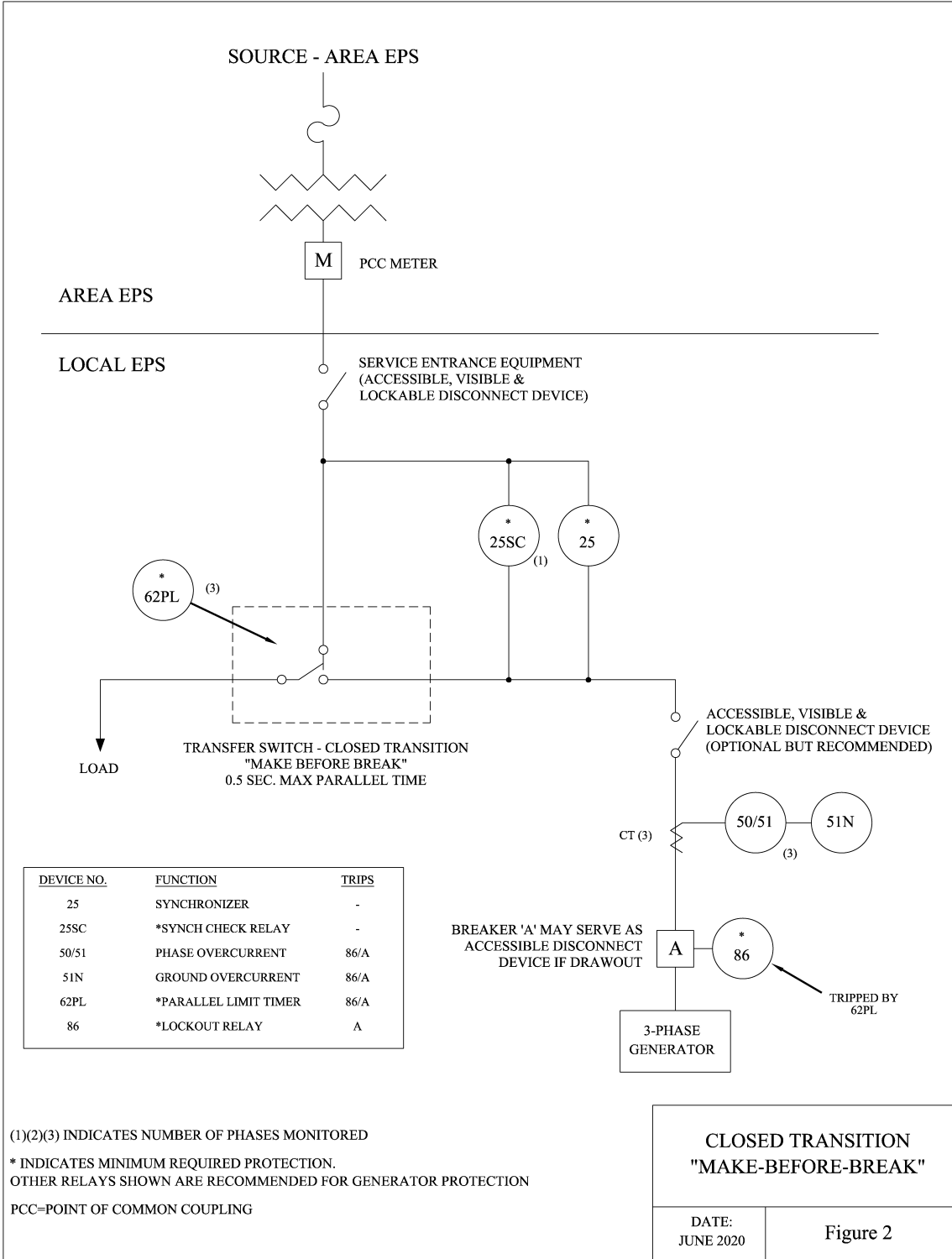

A-3 Soft Loading Transfer Switch – with Limited Parallel Operation

With Limited Parallel Operation – The DER generation is paralleled with the Area EPS for a limited amount of time (generally less than 2 minutes) to gradually transfer the load from the Area EPS to the DER generation. This minimizes the voltage and frequency problems, by softly loading and unloading the DER system.

- The maximum parallel operation must be controlled via a parallel timing limit relay (62PL). This parallel time limit relay must be via a completely separate relay and not part of the generation control PLC.
- Protective relaying is required, as shown in the following figure:

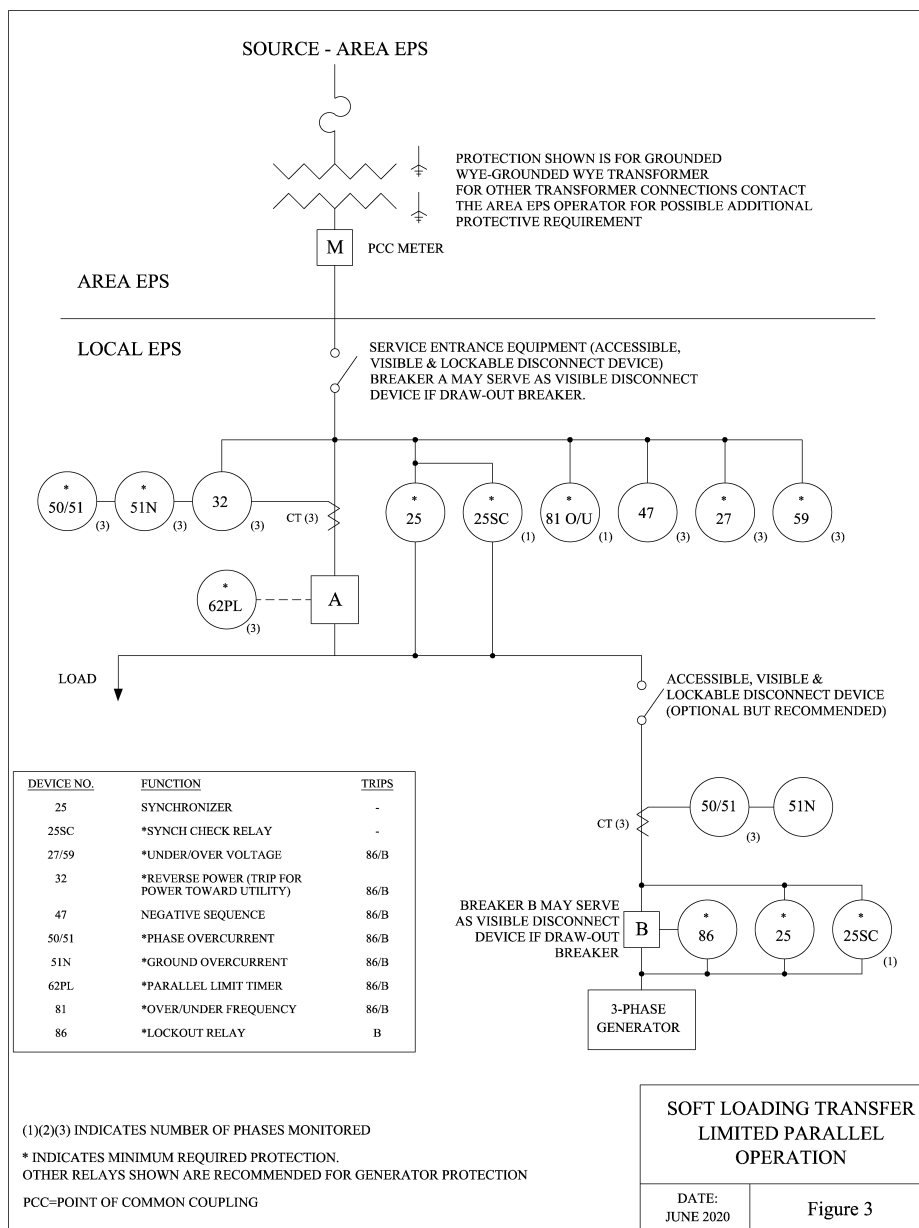

A-4 Soft Loading Transfer Switch – with Extended Parallel Operation

With Extended Parallel Operation – The DER generation is operated in parallel with the Area EPS. Special design, coordination and agreements are required before any extended parallel operation will be permitted. The Area EPS interconnection review will identify any issues involved.

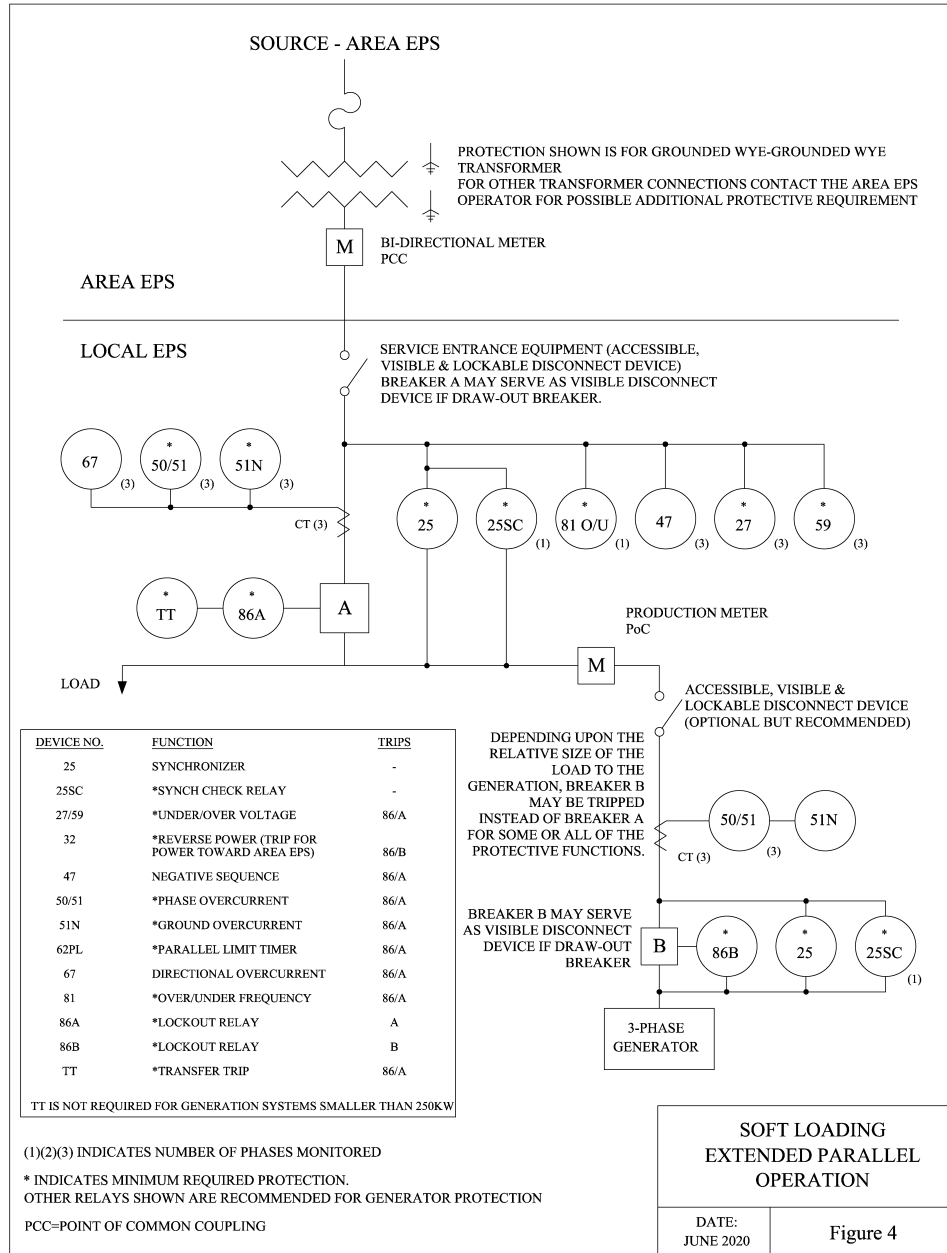

A-5 Inverter Connected DER

This is a continuous parallel connection between the DER and the Area EPS. Solar, wind and energy storage systems are some examples of DER systems which typically use inverters to convert from DC to AC and to interconnect to the Local EPS or Area EPS. Larger and multi-inverter systems may require additional protection systems. See the Protection section of this TSM for guidance. The design of such inverters must either contain all necessary protection to prevent unintentional islanding, or conventional protection must be installed to achieve the same protection.

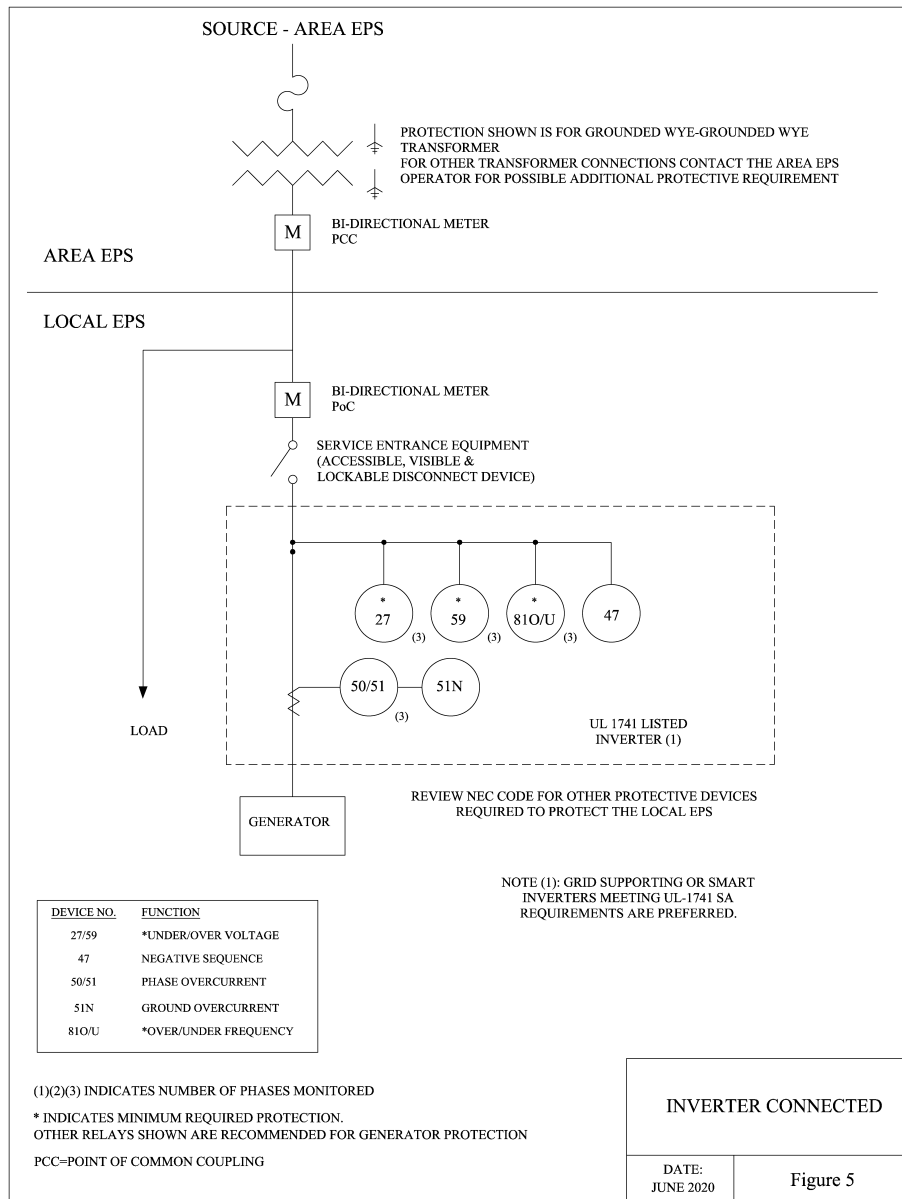

Appendix B – Protective Relaying Elements

The different types of relaying and the protective relaying elements are described below. There are different protective relaying requirements depending upon the type and size of the DER being interconnected with the Area EPS. Appendix A provides basic guidance for the protective relaying requirements for the different types of DER. Appendix B provides more detailed information about the different protective relaying elements and basic information why the element is used and information about setting the relaying elements.

To ensure proper coordination with the protective devices on the Area EPS, the Local Utility requires the Interconnection Customer to submit the protective relaying settings to the Local Utility prior to any interconnection operation. A review of the settings will be made including a review of the coordination between the DER protection settings and the Area EPS protection systems. This is not a complete review of the DER protection, and it remains the responsibility of the Interconnection Customer to ensure that there are adequate systems in place to protect the DER and the general public.

Once the protective relay settings have been reviewed and approved by a representative of the Area EPS Operator, the Interconnection Customer must complete a functional test of the protective relaying systems including injecting current and voltage into the relays to actually trip the associated breaker(s) or switch(es), as described in earlier sections of the TSM.

The following is a discussion about each of the protective relaying elements:

1. Over-current relay (IEEE Device 50/51 or 50/51V or 51N) This element senses current and triggers the tripping on current greater than a specified level. This element must operate to trip the protecting breaker at a level to ensure protection of the equipment and at a speed to allow proper coordination with other protective devices. Phase fault detection schemes are required to detect faults on the Area EPS. For example, the over-current relay monitoring the interconnection breaker must operate fast enough for a fault on the Interconnection Customer's equipment, so that no protective devices will operate on the Area EPS. 51V is a voltage restrained or controlled over-current relay and may be required to provide proper coordination with the Area EPS.
2. Directional over-current relay (IEEE Device 67) This element uses the phase relationship of the voltage and current to determine direction of the fault.
3. Over-voltage relay (IEEE Device 59) must operate to trip the DER per the requirements of IEEE 1547. See table in Section 5.1.1 and 5.1.2 for setting requirements.

4. Under-voltage relay (IEEE Device 27) must operate to trip the DER per the requirements of IEEE 1547. See table in Section 5.1.1 and 5.1.2 for setting requirements.
5. Over-frequency relay (IEEE Device 81O) must operate to trip the DER off-line per the requirements of IEEE 1547. See table in Section 5.1.3 for setting requirements.
6. Under-frequency relay (IEEE Device 81U) must operate to trip the DER off-line per the requirements of IEEE 1547. See table in Section 5.1.3 for setting requirements.
7. Sync-check relay (IEEE Device 25 / 25SC) must operate to block closing or reclosing of a breaker if the voltage and/or the phase angle is outside a preset bandwidth. Typical values for sync-check relays are within +/-10% of nominal for the voltage and within +/- 10% for the phase angle.
8. Phase sequence or phase balance detection (IEEE Device 47) Provides protection for rotating equipment from the damaging effects of excessive negative sequence voltage resulting from a phase failure, phase unbalance and reversed phase sequence. This element helps the DER sense loss of source issues on the Area EPS.
9. Reverse power relay (IEEE Device 32) This element senses power flowing from the DER to the Area EPS and must operate to trip the DER off-line for a power flow to the system with a maximum time delay of 2.0 seconds. This protective element provides a form of backup protection for problems which are not detected by the other protective relaying elements.
10. Lockout relay (IEEE Device 86) is a mechanically locking device which ensures a breaker or disconnect is not automatically reclosed into a faulted piece of equipment. The lockout relay is tripped by the protective relay and in turn trips the protective breaker and/or switch. When a lockout relay is required, the protective relay does not directly trip the breaker, but instead sends the trip signal to the lockout relay which then trips and relays that signal to the breakers and switches which need to trip. The lockout relay is also wired into the close circuit of a breaker or switch and prevents reclosing of the breaker when tripped by the protective relay. This is accomplished by blocking ALL close signals from reclosing the breaker. This lockout relay then requires a manual resetting of the lockout relay before the breaker can be reclosed. Lockout relays are used to ensure that a de-energized system is not re-energized by automatic control action and prevents a failed control from auto-reclosing an open breaker or switch.

11. Transfer trip – All DER(s) are required to disconnect from the Area EPS when the Area EPS is disconnected from its source to avoid unintentional islanding. With larger DER(s), which remain in parallel with the Area EPS, a transfer trip system may be required to sense the loss of the Area EPS source. When the Area EPS source is lost, a signal is sent to the DER to separate the DER generation from the Area EPS. The size and type of the DER vs the capacity and minimum loading on the feeder will dictate the need for transfer trip installation. The Area EPS interconnection study will identify the specific requirements.

If multiple electric utility sources are available or there are multiple points of sectionalizing on the Area EPS, then more than one transfer trip system may be required. The Area EPS interconnection study will identify the specific requirements. For some installations, the alternate Area EPS source(s) may not be utilized except in rare occasions. If this is the situation, the Interconnection Customer may elect to have the DER locked out when the alternate source(s) are utilized, if agreeable to the Local Utility.

12. Parallel limit timing relay (IEEE Device 62PL) set at a maximum of 120 seconds for soft transfer installations and set no longer than 500ms for closed transfer installations, must trip the DER circuit breaker on limited parallel interconnection systems. Power for the 62PL relay must be independent of the transfer switch control power. The 62PL failsafe timer must be an independent device from the transfer control and must not be part of the generation PLC or other control system.

13. Under power relaying protection is a setting within a digital relay that will trip a DER if the level of energy flow from the Area EPS goes below a set value. This protection system may be used by the DER to detect faults on the Area EPS. Under powered relaying schemes must be set to trip immediately upon sensing under power levels and must coordinate with the Area EPS system. Under power relaying is not allowed for DER systems which have the potential for inadvertent energy flow onto the Area EPS.

---DRAFT---MEMBER RESOLUTION

RESOLUTION _____

WHEREAS, the Public Utility Regulatory Policies Act of 1978 (PURPA), as amended, requires a utility to buy power and sell power to Qualifying Facilities (QF);

WHEREAS, the MEMBER and Missouri River Energy Services (MRES) filed a Petition of Waiver, which specifies the obligations of the MEMBER and MRES to a QF, with the Federal Energy Regulatory Commission (FERC) under Section 210 of PURPA, and have been granted such waiver by the FERC;

WHEREAS, the MEMBER and MRES agreed to comply with “Rules of Compliance” as part of the Waiver;

WHEREAS, the MEMBER has drafted guidelines and documents to implement the Rules of Compliance known as the “Distributed Generation Workbook for Minnesota members” to accommodate QFs in interconnection and power purchase arrangements, which are subject to be updated periodically;

NOW, THEREFORE, BE IT RESOLVED that in recognition of the above statements, the MEMBER hereby adopts the Distributed Generation Workbook for Minnesota members as the “Small Power Production and Co-Generation Policy.”

Chair

Adopted:

Pre-Application Report

This report summarizes information available to the Local Utility regarding an interconnection of a distributed energy resource to the Local Utility's distribution system. The report includes only information that is readily available to the Local Utility. This report is not a guarantee by the Local Utility that a future interconnection application will be approved for the proposed site. Information provided in this report is subject to change as modifications are made to the Local Utility's distribution system.

Pre-Application Request			
Pre-Application ID:			
Project Address:			
DER Size:		kW AC	DER Type:
Project Contact:			
Email:		Phone:	

Electric Distribution System Information			Info Not Available
Total capacity of the circuit based on normal conditions likely to serve the proposed PCC		MW AC	
Existing aggregate generation capacity interconnected to the circuit likely to serve the proposed PCC		MW AC	
Aggregate queued generation capacity for the circuit likely to serve the proposed PCC		MW AC	
Available capacity of the circuit most likely to serve the proposed PCC		MW AC	
Estimated peak load of relevant line sections		kW AC	
Estimated minimum load of relevant line sections (daytime minimum load to be specified for solar DER, if available.)		kW AC	
Substation Voltage (Nominal Distribution)		kV	
Substation Voltage (Nominal Transmission)		kV	
Nominal distribution circuit voltage at proposed PCC		kV	

PCC: Point of Common Coupling

Electric Distribution System Information – Continued

			Info Not Available
Approximate circuit distance between the proposed PCC and the substation:		Miles	
Distance to three phase circuit (if not already located on a three-phase circuit):		Miles	
Limiting conductor ratings from the proposed PCC to the substation		Amps	
Number of available phases on the Area EPS at the proposed PCC		Phases	
Is the proposed point of common coupling located on a spot network, grid network, or radial supply?	<input type="checkbox"/> Yes <input type="checkbox"/> No		
Is the proposed PCC located behind a line voltage regulator?	<input type="checkbox"/> Yes <input type="checkbox"/> No		
Type of voltage regulating devices between substation and proposed PCC	Device A		
	Device B		
	Device C		
Number and type of protection devices between substation and proposed PCC	Device A		
	Device B		
	Device C		
Any additional known distribution system constraints?	<input type="checkbox"/> Yes <input type="checkbox"/> No		

Additional known constraints that could affect installation or operation of the DER or Area EPS at the proposed PCC are attached to this report. Constraints may include, but are not limited to, electrical dependencies at that location, short circuit interrupting capacity issues, power quality or stability issues on the circuit, capacity constraints, or secondary networks.

Utility Information

Report Completed By:			
Company:			
Project Contact:			
Email:		Phone:	

Storage Application

This form is required in addition to a completed Interconnection Application form for any DER with an energy storage component. An application to interconnect energy storage is only required for storage designed to operate in parallel with the distribution system. Electric vehicles and backup generators do not need to apply.

Energy Storage		
Application for:	<input type="checkbox"/> Stand-alone storage as DER <input type="checkbox"/> Storage as component of DER	
Customer Account Number:		
Address of Generating Facility:		
City:	State:	Zip Code:
Equipment Manufacturer:	Equipment Model:	
Max Continuous Real Power (In kW):	Max Continuous Apparent Power (In kVA):	
Power Factor range of adjustability:	Peak AC Energy (In kWh):	
Is the equipment UL 1741 listed? <i>Manufacturer specification sheet(s) are required to be attached to this application.</i>		<input type="checkbox"/> Yes <input type="checkbox"/> No
Is the storage 100% charged by a net energy metering eligible energy source?		<input type="checkbox"/> Yes <input type="checkbox"/> No
Source charging the storage (<i>Check all that apply</i>):		
<input type="checkbox"/> Utility <input type="checkbox"/> Wind <input type="checkbox"/> Solar <input type="checkbox"/> Diesel <input type="checkbox"/> Other (please specify)		
Is the storage configured to export energy to the Area EPS?		<input type="checkbox"/> Yes <input type="checkbox"/> No
Are the settings accessible to the end user?		<input type="checkbox"/> Yes <input type="checkbox"/> No

For Office Use Only	
Application ID:	Queue Number:
Date Received:	

Energy Storage

Available control operating modes:

Control modes being enabled for interconnection:

For non-export, how does the system determine the magnitude of customer load?

What is the process for changing operational modes of the energy storage?

Please attach any additional materials.